

twogether

Paper Technology Journal

ATMOS Premium Tissue | Energy efficiency – A challenge for the paper industry | Voith Paper Environmental Solutions





4

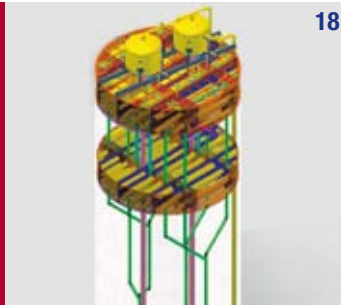

18



47

Report

- 4 **Energy efficiency –**
A challenge for the paper industry
- 40 **ahead07 –**
Vienna Remains the Venue for Board and Packaging Paper Producers
- 72 **Voith celebrates its 140th anniversary –**
1867 - 2007

Interview

- 16 **Voith Paper Environmental Solutions –**
A new future-oriented division

Technology

- 11 **Reducing energy costs –**
A challenge in stock preparation
- 18 **The anaerobic reactor –**
Setting new benchmarks in effluent treatment, even with high lime content
- 22 **Bowater Calhoun PM 4 rebuild –**
Realignment to more profitable markets
- 26 **ATMOS Premium Tissue –**
35% energy savings and much lower investment costs

Germany
Land of Ideas
●●●●●●●●●●
Official Partner

- 29 **Greater value-added through improved cross-profile control**
- 44 **Developments in board production –**
Trends on the global carton market
- 47 **Mondi Business Paper, Ruzomberok –**
PrintTech LBR dryer fabrics improve efficiency
- 50 **Graphic Packaging International –**
Promoting synergies through partnership
- 54 **Preparing for tomorrow –**
Designed for the future!
- 57 **NipcoFlex Calender –**
A new means for crowning the finishing process
- 60 **High Technology on a Roll Part 2**
- 63 **New Thermal Spray Coating production line started-up in China**
- 66 **Total Roll Management –**
The Ultimate Roll Service Concept
- 68 **Product finder –**
The Voith Paper offering, now online

R&D

- 32 **First Anniversary of the Voith Paper Technology Center (PTC) –**
Success through Innovation
- 34 **New speed record on the Voith PTC VPM 6 pilot paper machine –**
Over 2,000 m/min with Single NipcoFlex press

- 35 **Process optimization, analysis and stabilization with PaperMiner –**
A service which turns database information into know-how
- 36 **Innovative drying technology enabling speeds in excess of 2,000 m/min –**
HiDryer: the speed and quality module
- 38 **Comprehensive know-how in pressing technology –**
The FeltView press felt analysis system
- 39 **New Engineered “Diamond Edge” for dryer fabrics –**
Lasts up to three times as long

Voith Group news

- 70 **Voith Industrial Services, fully integrated –**
The Münzing Chemie success story in Heilbronn
- 71 **Borçka hydro power plant inaugurated by Turkish prime minister Erdoğan**
- 71 **Voith Turbo launches commercial WinDrive production**

Regular features

- 3 **Editorial**
- 76 **Imprint**

*Dr. Hans-Peter Sollinger
Member of the Corporate
Management Board Voith AG
and President of Voith Paper*



Dear customers and other readers,

It is now twelve months since we inaugurated our Paper Technology Center (PTC) in Heidenheim. This edition of twogether magazine reports on the first year of R&D activities there, and we are proud to say that results achieved at the new PTC have exceeded our expectations.

During this time we have also developed our "step change" innovations, on which we have been working for several years, to market maturity. Their first installations in practice with our pilot-trial customers have met the highest demands. Detailed reports on two of these innovations are included in this issue.

One of them is ATMOS, an innovative production process for premium tissue. This saves 35% of energy costs and substantially reduces investment costs, with the same or even better product quality than TAD tissue.

Our new "Environmental Solutions" division has developed some innovative processes and systems that sig-

nificantly reduce waste and effluent disposal costs with the additional bonus of power generation. These concepts were met with considerable interest not only in the paper industry, but also in other water-intensive sectors such as the brewery industry.

An important principle with these innovations was to take a fresh look at existing concepts, in order to find really new solutions with advantages difficult to visualize at first sight.

Energy savings and cost reductions were of course our primary innovation goals, and with ATMOS and Environmental Solutions we have reached these goals. But overall savings potential throughout the papermaking process is still enormous. Cost savings, still our primary objective, can, however, not be everything we want to achieve with innovations.

Paper quality improvements are of course an ongoing requirement of our customers. The Voith PTC offers for that ideal conditions. From chemicals to fabrics to automation concepts, every single aspect of the complex

papermaking process can be orchestrated here for optimally harmonic development. Voith customers can systematically develop their new products at our PTC and test their market response before investing heavily in production facilities. Here again, a key role is played by step change innovations – new paper grades, and new paper and packaging applications.

As always, we only see a glimpse here of our future challenges and opportunities. The ongoing challenge however is creative innovation – and that is our calling.

Meanwhile, this twogether 24 edition will doubtless provide you with stimulating reading.

On behalf of the Voith Paper team

Energy efficiency – A challenge for the paper industry

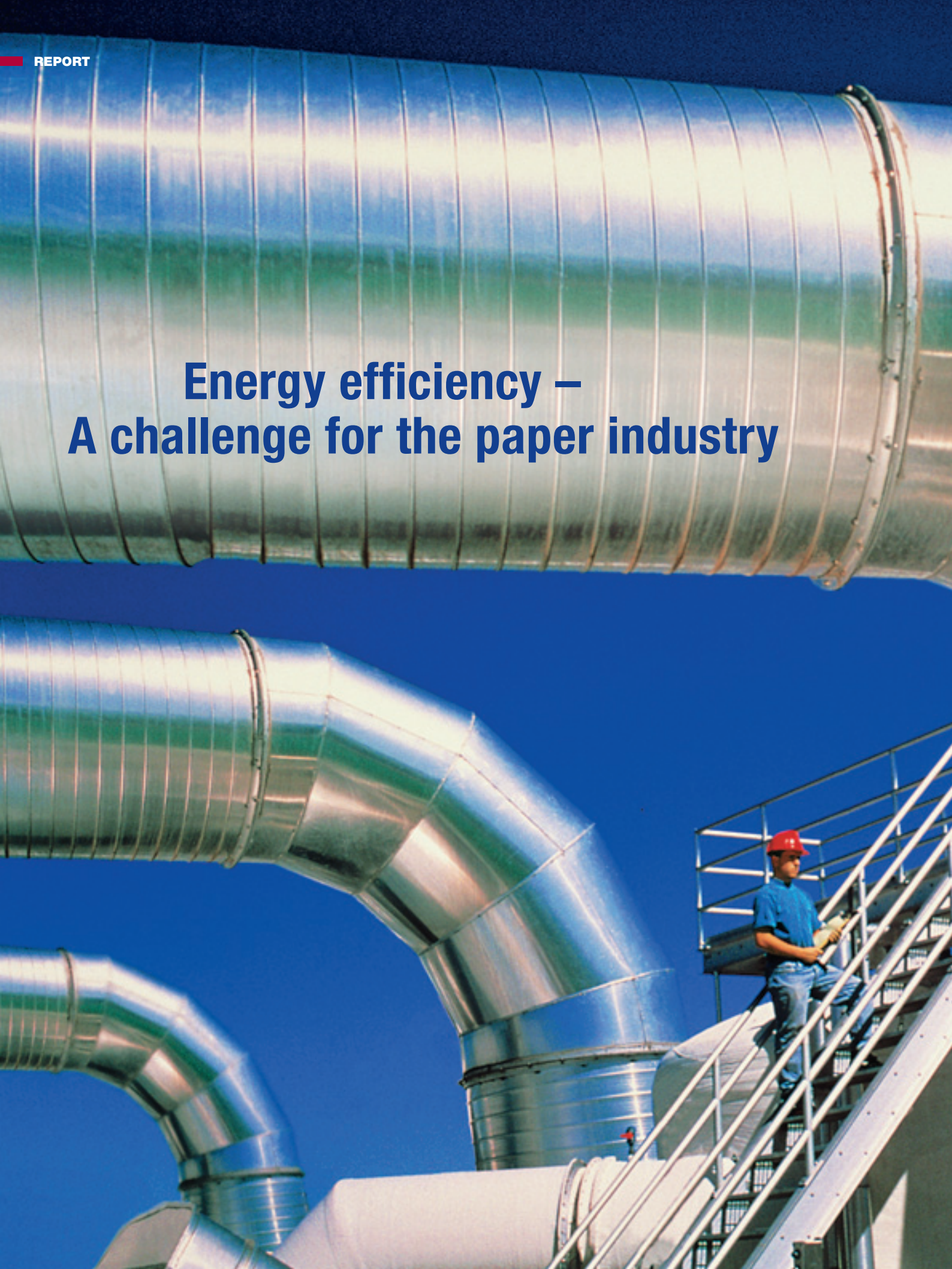





Extreme droughts: a typical consequence of global warming due to high energy consumption

Globalisation opens up completely new opportunities to those who can master the challenges. But the unprecedented dynamics of the new global market are driven almost exclusively by finite fossil resources including above all coal, oil and gas. This headlong market development also has a big drawback: energy prices are rising according to the law of supply and demand. Furthermore, global warming is having an increasingly political impact worldwide – the exceptionally mild winter in Europe, disastrous rainfall in the USA, extreme drought in Australia... climate change is an international and political long-runner.

Primary energy needs worldwide

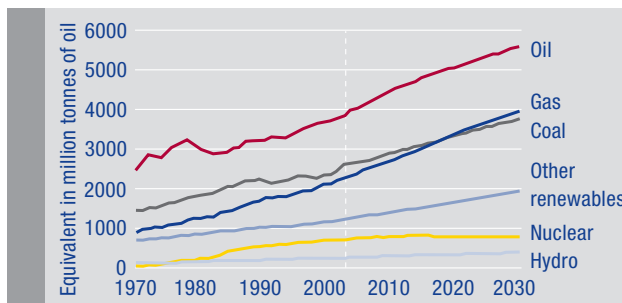

Power tariffs in Europe, 1997-2007

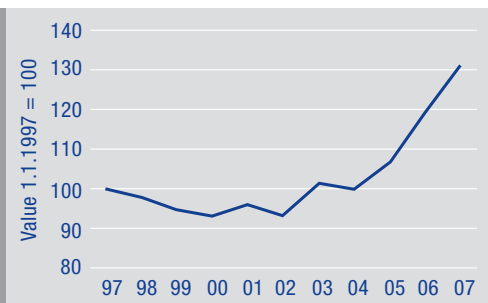



Renewable energy resources: the sooner the better!

The paper industry has taken the lead in improving energy efficiency and promoting industrial sustainability. Paper is made from naturally regenerating resources, bio-energy already covers much of the energy requirements, and production increases go hand in hand with steadily rising energy efficiency. This is the path the paper industry must continue to follow in the future.

While energy shortages and the resulting price increases are a consequence of globalization, they are also being used as a political tool for combating global warming. At the

Brussels summit conference last March, German Chancellor Angela Merkel, as current president of the EU Commission, committed the member states to a climate protection pact. Its goals are ambitious: by the year 2020 greenhouse gas emissions are to be reduced by 20%, while renewable energy usage should be raised to 20% and energy efficiency is to be increased by 20%.

The 27 EU states are free to devise their own ways of reaching these goals. Given these ambitious targets the energy-intensive paper industry will continue to face even tougher

conditions going forward. Even today paper companies are increasingly having to pay for the liberalization of the European energy market.

At the beginning of 2002 German paper mills were charged 34 Euro per Megawatt hour, and by the end of 2006 this had risen to 62 Euro. Gas tariffs have more than doubled from 11.5 Euro/MWh at the beginning of 1999 to 30 Euro/MWh at the end of 2006.

Global conditions are expected to challenge the energy situation even more – declining resources and

Gas tariffs in Europe, 1997-2007



Crude oil price development 1996-2005

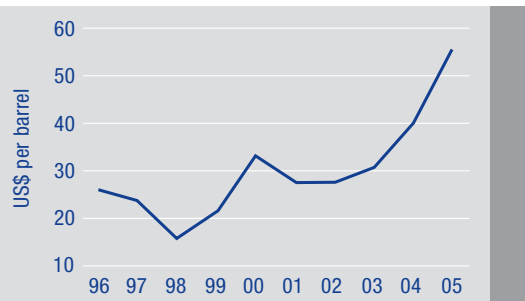

Global coal price development 1996-2005

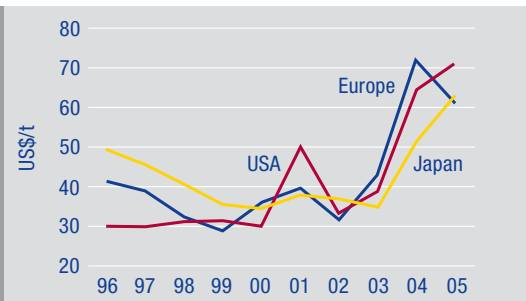

global warming know no frontiers. According to the latest UNO report energy consumption is likely to double over the next 25 years, about two thirds of which is attributable to the developing countries alone.

The USA still derives two thirds of its energy from oil, and causes about one fifth of global CO₂ emissions, closely followed by China.

The Bush administration has recently signalled its readiness to cooperate with international efforts against global warming and the climatic consequences, and there is every indication that the United States is looking to innovative technologies as a solution. However, current US government funding to this end is much lower than in the European Union.

China's energy consumption is rising just as rapidly as its economic growth. Coal consumption as a primary energy source had already reached 2.14 billion tons p.a. in 2005, 10.6%

more than in the previous year, and fuels are increasingly being procured on the global market. However, the Chinese government is already including alternative energy resources in its economic planning. Renewable energy utilization is to rise from 7 to 15% by 2020 – mainly consisting of hydropower.

Economic growth in India over the last few years has not driven energy consumption so high as in China, but India's energy supply infrastructures are being improved now. South America and Russia, with their rich natural resources of oil and gas, are well situated with regard to future economic growth.

The bottom line is: energy prices are rising and political conditions are increasingly ambiguous. Papermakers can make the best of this situation by using it as an incentive to optimize their processes with an eye on energy, and thereby sustainably improve their profitability and competitiveness.

China's Three Gorges Dam hydro project, one of the world's biggest and also involving Voith



*The EcoProcess:
trend-setting for stock preparation*

Voith is well versed in all aspects of energy. Whether in power generation or energy applications, Voith has always been on the front line of development with innovative solutions. Voith is the right partner for the paper industry because Voith not only offers cost effective components that save energy, but also has the comprehensive expertise required for optimizing the entire papermaking process. A lot has already been achieved 'together' in the past – for example, converting newsprint production from energy-intensive mechanical pulp to environmentally friendly and energy efficient recovered paper.

One of Voith's greatest strengths undoubtedly lies in its comprehensive

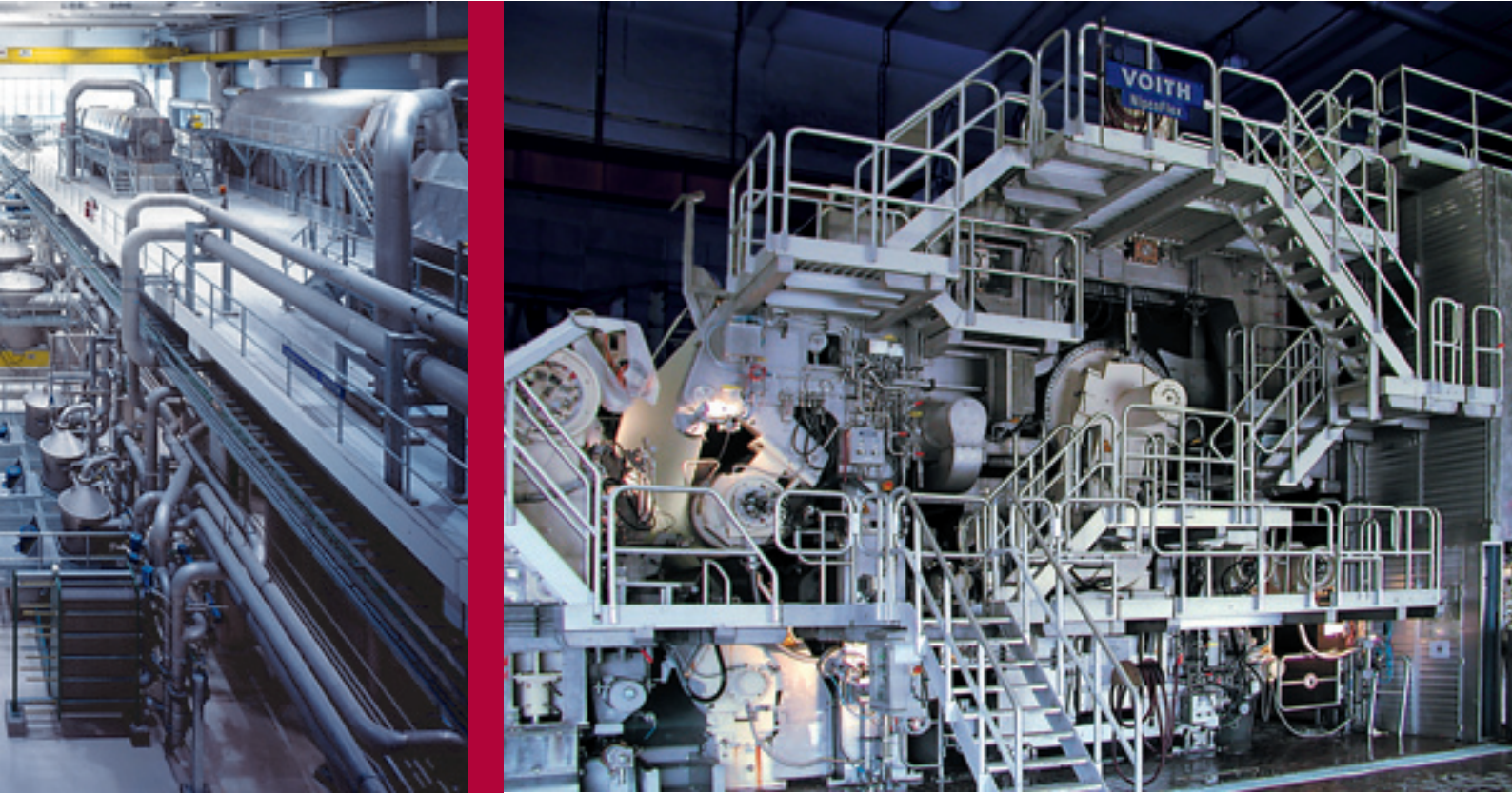

The Single NipcoFlex press consumes about 30% less drive and vacuum power

papermaking know-how, with energy efficient concepts covering the entire papermaking process to guarantee maximum production and dependable stability. Complete production line auditing ensures the best possible basis for this know how.

Voith recently conducted an in-depth energy audit of two paper machines by measuring and evaluating over 400 drives and associated line components. The partner for this pilot project was Koehler Paper in Kehl, Germany, where two Voith paper machines are operating. PM 1 is 13 years older than PM 2, which was built according to the One Platform Concept. These machines make an ideal pair to illustrate the technologi-

cal progress with regard to energy savings. The verdict was clear: PM 2 uses about 404 kWh per ton of paper less than PM 1 – which was significantly optimized afterwards.

Voith not only pioneered energy auditing on Kehl PM 1 and PM 2, by focusing on the paper machines themselves, but is also breaking new ground in stock preparation. The approach here is to interlink process stages more closely, exploit high stock consistencies, and use mixing pumps and direct injection for rapidly changing stock consistency. This minimizes the number of pumps, vats and towers required and avoids unnecessary pressure changes. Through systematic use of variable

speed pumps the flows can be precisely adjusted at all times to actual needs according to application. With these trend-setting principles Voith is taking the decisive step from conventional papermaking, to “EcoProcess”.

A particularly effective energy-saving device in this area is the EcoMizer. The EcoMizer is a hydrocyclone type cleaner for the upper stock consistency range which requires significantly less pumping effort. For example, installing a series of EcoMizers in a German newsprint line has already paid off with annual energy cost savings of 700,000 Euro.

Overall energy savings with the EcoProcess on an 800 t/d deinking line,



*Papervision – new solutions for the future
(numerous patents registered)*

incorporating Eco Mizer, EcoDirect disperger and production regulation system, amount to 10%. This represents a reduction in demand to a level of about 350 kWh/t. Further innovative technologies are also available for significant additional savings.

The introduction of shoe presses in paper machine technology has also brought significant energy savings. In fact, much of the energy savings on Kehl PM 2 compared with PM 1 are attributable to the shoe press nip in the newer machine.

Meanwhile, Voith has made further energy-saving progress with the Single NipcoFlex press. Utilizing only one nip, this press concept requires about 30% less drive power and vacuum energy at high dry contents.

Suction roll drive power requirements can be significantly reduced by installing SeaLencer sealing strips. Thanks to the resultant energy savings with this system, payback times can be as low as 1-2 years.

Another effective component for fast paper machines is the Pro-Release stabilizer. This not only stabilizes the web run in the first dryer group, but also has an energy-saving mechanical seal. High machine efficiency at high production speeds also saves energy by drastically reducing web break frequency.

For board and packaging paper lines the BoostDryer has a very favourable effect on the energy balance. Boost-Dryer technology combines high drying performance with improved paper quality, for example, good strength properties with less sizing. This saves energy because less water has to be evaporated in the afterdryer section.

To summarize: With the ongoing rise in energy costs, future market success will belong to those who optimize their production facilities for maximum efficiency and minimum energy consumption. Voith is a committed and competent partner to the paper industry for the comprehensive optimization of productivity, quality

and stability. While continuously working to reduce operating and investment costs through innovative and trend-setting solutions.

Contact



Susanne Haase
Author/Journalist
mail@susannehaase.de



Dr Sören Köster
Voith Paper F&E
soeren.koester@voith.com



Dr Martin Staiger
Voith Paper F&E
martin.staiger@voith.com



Energy costs are steadily rising
(source: VIK power tariff index)

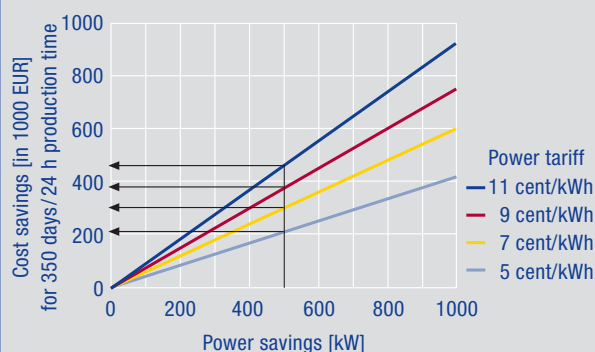

Energy savings immediately reduce costs

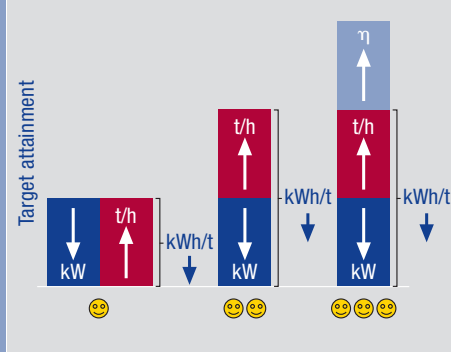

Optimization measures bring various results

Reducing energy costs – A challenge in stock preparation

Energy costs, averaging 14% of overall costs in German paper mills, are among the highest production expenditures in paper-making. The average cost per megawatt hour (MWh) in Germany rose by more than 60% from 2005 to 2006. Against the background of dwindling fossil fuel resources, and the slow development of alternative energy sources, such drastic increases in energy prices can also be expected in the future. Voith has long been taking countermeasures against this trend by continually identifying energy savings and optimization possibilities, not only in systems as a whole, but also in individual operating modules.

In fact, Voith has already realized numerous energy-saving concepts in recent installations, such as the Eco-Process that can save up to 44 kWh per ton of production output in comparison to conventional installations.

The following examples, focusing on the energy consumption of individual stock preparation modules, show how incremental modifications to machinery and systems can save

energy, and in many cases improve performance at the same time. The specific energy consumption per ton of output can be reduced significantly.

Such rebuild or retrofit measures are feasible not only on Voith stock preparation systems, but also on equipment from other manufacturers. The energy saving is recognized immediately on overall production costs.

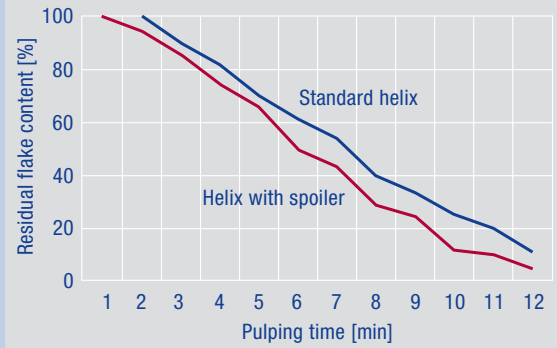
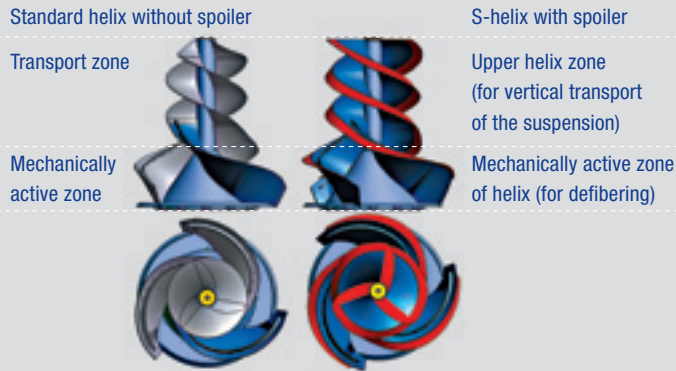

Converting a standard helix into an S-helix reduces pulping time and improves pulping results

How to save energy?

There are two basic energy-saving principles: either take direct measures to reduce power consumption, or save energy indirectly by increasing production output for the same power consumption. The result in both cases is a reduction of specific energy consumption per ton of finished stock.

Energy-saving optimization often improves the technological parameters as well. This can be illustrated by dividing improvement measures into various categories:

- ☺ Reduce specific energy consumption by lowering power consumption or by increasing production throughput for the same power consumption.
- ☺☺ Reduce power consumption while increasing production throughput or improving technological results – a double gain.
- ☺☺☺ Optimally: Reduce power consumption, increase production and improve technological results.

In a HC pulper, for example, hydrodynamically optimizing the spoiler helix saves 15-20% energy ☺☺☺

Energy input via the helical rotor in a HC pulper efficiently defibers the furnish at more than 15% consistency, and at the same time shears off ink particles from the fibers for more effective deinking. The pulper vat and helix have to be specially designed for this purpose. A low rotor speed ensures controlled circulation of the high-viscosity suspension in the vat. Mechanical agitation and the addition of specific deinking chemicals help to break down the suspension into individual fibers and to separate ink particles from the fiber surfaces.

Depending on furnish characteristics and defibering requirements, the specific energy consumption can vary from 18 to 50 kWh/t. Voith's latest design advances in helix geometry have led to a spoiler contour on the upper part of the helix – hence the name S-helix.

Nearly all types of helix can be modified with a hydrodynamically optimized spoiler, a measure that shortens pulping time with the same or better defibering results. In some cases, it has even been possible to reduce the amount of deinking chemicals, thus achieving further cost savings. Another advantage is that the stock consistency in HC pulpers can be slightly increased. In general, using an S-helix can save 15 to 20% specific pulping energy.

In screening machines, the optimal combination of rotor and basket design can save from 5-30% of energy costs

Optimally configuring a vertical screen provides significant energy cost savings, and usually increases throughput capacity as well. The wide range of Voith screening rotors and baskets enables custom-tailored configurations for every application. Energy cost savings usually go hand in hand with the same or better screening results.

Typical energy savings attained by modifying vertical screen rotors	
Conversion from/to	Energy savings in %
Bump/MultiFoil rotor	approx. 30-40
Lobed/stepped rotor	approx. 10-15
Continuous foil/ MultiFoil rotor	approx. 5-10

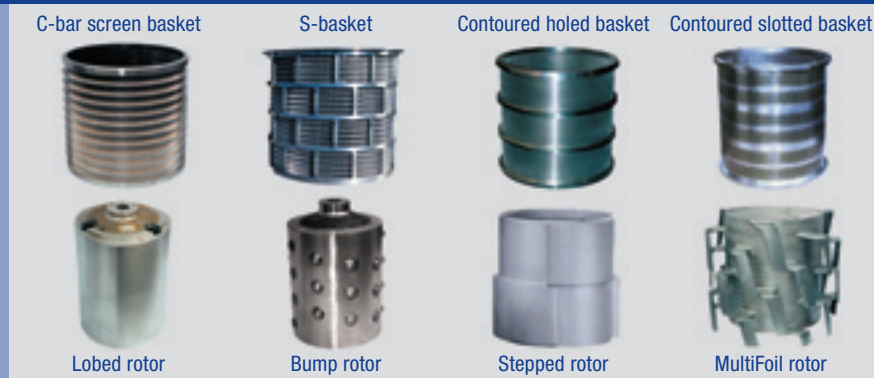

Screen basket and rotor portfolio (patented)

Screening technology has a long history, not only at Voith. Numerous manufacturers have tried out various concepts, rotor and basket designs over the years. With regard to screening results, energy consumption and overall operating costs, the MultiFoil rotor combined with a C-bar basket is the best solution so far. In fact, the quality thus attained by Voith remains unmatched by any other manufacturer. For difficult applications, above all with holed screening, best results are attained using a stepped rotor with contoured holed or slotted baskets.

This kind of rotor can also be classified as an energy saver.

Rotors with continuous foils, or fast-running, full-mantle designs such as the bump or lobed rotor, are seen less and less on the market these days because MultiFoil or stepped rotors are a better alternative. This trend can be observed worldwide.

Rebuilds, both for stock preparation and in the approach flow system, are

a worthwhile solution for outdated production lines. Our extensive experience with rebuilds have shown that in addition to significantly reducing power consumption, production throughput increases and screening efficiency are also improved in most cases.

Before rebuilding screens, we always recommend carrying out a brief analysis to get an overview of optimization potential. We can then propose definitive optimization measures and also provide a clear estimate of return on investment.

Examples of screening optimization solutions

Energy consumption reduced by 35% 😊

Problem 1: High screening power consumption.

Solution: By using fine-profile contoured holed or slotted baskets, the rotor speed required for cleaning the screen surfaces can be reduced.

Example (for a customer in Germany): Rebuild of five Black Clawson screens from conventional bar type baskets to contoured baskets without changing production throughput or screen hole diameter. This enabled a 20 % reduction of rotor speed without affecting production output. Reducing the rotor speed saved 35% energy consumption.

Energy consumption reduced by 20%, and screening quality increased 😊😊

Problem 2: Poor screening quality due to high slot flow velocities.

Solution: A basket with greater open area reduces mean throughflow velocity for more effective screening. The best solution is the C-bar QE basket, which has bars that are 20% narrower than the standard C-bar SE version.

While narrower bars give better screening results, they also cause slightly more fractionation. Also important is the kind of furnish being

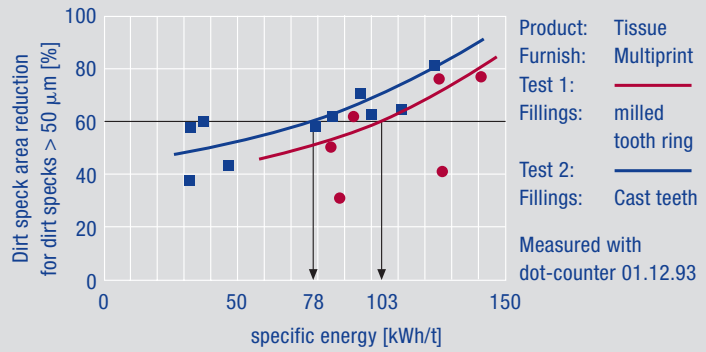

Conversion package: C-bar screen basket/MultiFoil rotor with belt pulley for speed adjustment (patented)

High-Toothed disperger fillings compared with milled-tooth ring fillings

screened, to prevent plugging of the screen basket surface.

By increasing capacity, this measure either saves about 20% of specific energy costs or improves screening quality with otherwise unchanged parameters.

Throughput capacity increased by 20%, and bottleneck eliminated 😊

Problem 3: Increase in paper machine production cause higher rejects rates in the approach flow screens, and overloading of the last screening stage.

Solution: Increase screen throughput capacity by fitting the screen with a MultiFoil rotor and a C-bar basket.

Example (for a customer in Germany): Rebuilding Omega screens with MultiFoil rotors and C-bar baskets increased throughput of the final screening stage by 20% with the same slot width.

By ensuring dependable operation of the first screening stage, this rebuild

enabled a 30% production increase of the paper machine.

A complete success right down the line 😊😊😊

Problem 4: A customer in Thailand wanted to optimize the approach flow screen for greater throughput capacity, and the customer also required better paper quality.

Solution: Rebuilding the Black Clawson screens by fitting MultiFoil rotors with speed modification, and using C-bar technology with slot width reduction from 0.45 to 0.30 mm, enabled:

- 47% less power consumption
- stickies separation efficiency improvement from 25% to 63%
- overall stock loss reduction from 0.4% to 0.1%
- 20% higher maximum throughput.

High-toothed disperger fillings save up to 20% energy and improve stock quality 😊😊

High-toothed disperger fillings save up to 20% energy and improve stock quality.

Numerous older dispergers have already been converted to modern high-toothed fillings. These comprise the well-proven high-toothed cast fillings that are also used in the latest DX disperger series with direct heating.

Upgrading with high-toothed fillings instead of milled or cast fillings with low-profile teeth has always brought improvements, whatever the application, resulting in energy savings up to 20%.

Furthermore, of all technological advances, our customers have benefited most from those that address product cleanliness. In several cases this also had a positive effect on paper machine operation.

Voith dispergers with modern high-toothed fillings technology have proved themselves in practice with maximum customer benefit. In teamwork with our engineers and specialized service technicians, Voith can tailor disperger fillings to the specific needs and circumstances of every customer.

Energy savings with the EcoMizer dilution concept on cleaner systems ☺☺☺

By upgrading with EcoMizer technology, existing cleaners can be rejuvenated.

To uphold rotation and reverse flow in the bottom of cleaner cones, a retrofit with an EcoMizer provides a new dilution module offering considerable advantages compared with conventional cleaner concepts:

- Greater reliability, particularly for furnishes with high tendency of thickening.
- Lower overall overflow rates.
- Fewer cleaner stages required (two or three fewer in stock preparation, and no more than four required in the approach flow system).
- Greater compactness and lower additional investment costs for pumps, drives, piping and MCR systems.
- About 30% savings on pumping power requirements.
- Sand separation possible at much higher stock consistencies up to 2.5%.
- Greater process layout flexibility, e.g. cleaners can be arranged upstream of flotation.
- Lower fiber losses thanks to higher contaminant concentration in the rejects, raising ash concentration thereby from about 40-50% to about 60-70%.

EcoMizer dilution modules can be retrofitted to practically all makes and types of cleaner. Rebuilding the cleaner is simple, and the payback time is very short. Voith Paper has proven this so far in more than 100 applications with payback times of less than one year in every case.

Our expert cleaner-service team will gladly advise you and is always available for on-site analysis of your requirements.

Summary and conclusions

Against the background of today's steadily rising energy costs, mill owners must pay greater attention to the challenge of reducing power and energy consumption. In other words, energy saving must become a priority.

The measures explained in this article are only some of the many possibilities for reducing energy costs and modernizing older production lines. Apart from their technological advantages, the interesting new energy saving solutions developed by Voith can be implemented rapidly, systematically, cost-effectively and irrespectively of limited maintenance budgets.

With the theoretical savings potential described here – 15% for an HC pulper, 35% for holed screening, 30% for slotted screening, 15% per disperger and 30% per cleaner group – the overall power savings on a

conventional deinking line total about 8.5%. For a deinking line with an output of 500 tons per day and a power consumption of 175 MWh/day or 61,250 MWh p.a. (350 days of operation), the power savings therefore amount to 5,206 MWh p.a. At a tariff of 70 € (\$90)/MWh, this provides a financial savings of 350,000 € (\$455,000) per year.

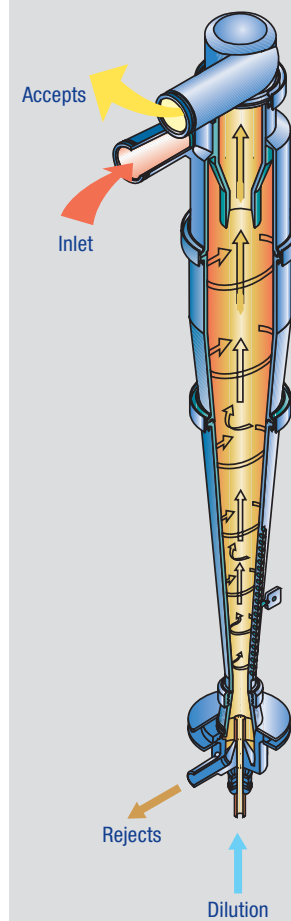

HCH5 cleaner with EcoMizer module at cone bottom (patented)

Contact



Werner Brettschneider
Fiber Systems
werner.brettschneider@voith.com



Voith Paper Environmental Solutions – A new future-oriented division

Werner Geßler

The zero-effluent paper mill is no longer a fiction! Mills in the industrialized nations currently use up to 20 cubic meters of fresh-water per ton of paper produced, and a lot more in developing countries. Innovative technologies are therefore in high demand for clarification and recycling mill effluent and to reduce fresh water consumption. And that is a pre-eminent capability of the newly founded Voith Paper Environmental Solutions (VPES) division with its more than 100 specialists worldwide. In this interview, VPES manager Werner Geßler explains these new ecological and economical oriented technologies and environment-friendly concepts.

twogether: Apart from saving fresh-water, the economical recycling of mill waste is one of the biggest challenges facing the paper industry. How is Voith dealing with this challenge?

Geßler: We have always paid great attention to recycling technologies.

Recovered paper is the biggest source of raw material for the paper industry at more than 50 percent, and thanks to Voith Paper Fiber Systems process technologies, the contaminants in recovered paper are removed very efficiently. In modern packaging paper lines, for example, the rejects and residuals to be disposed range

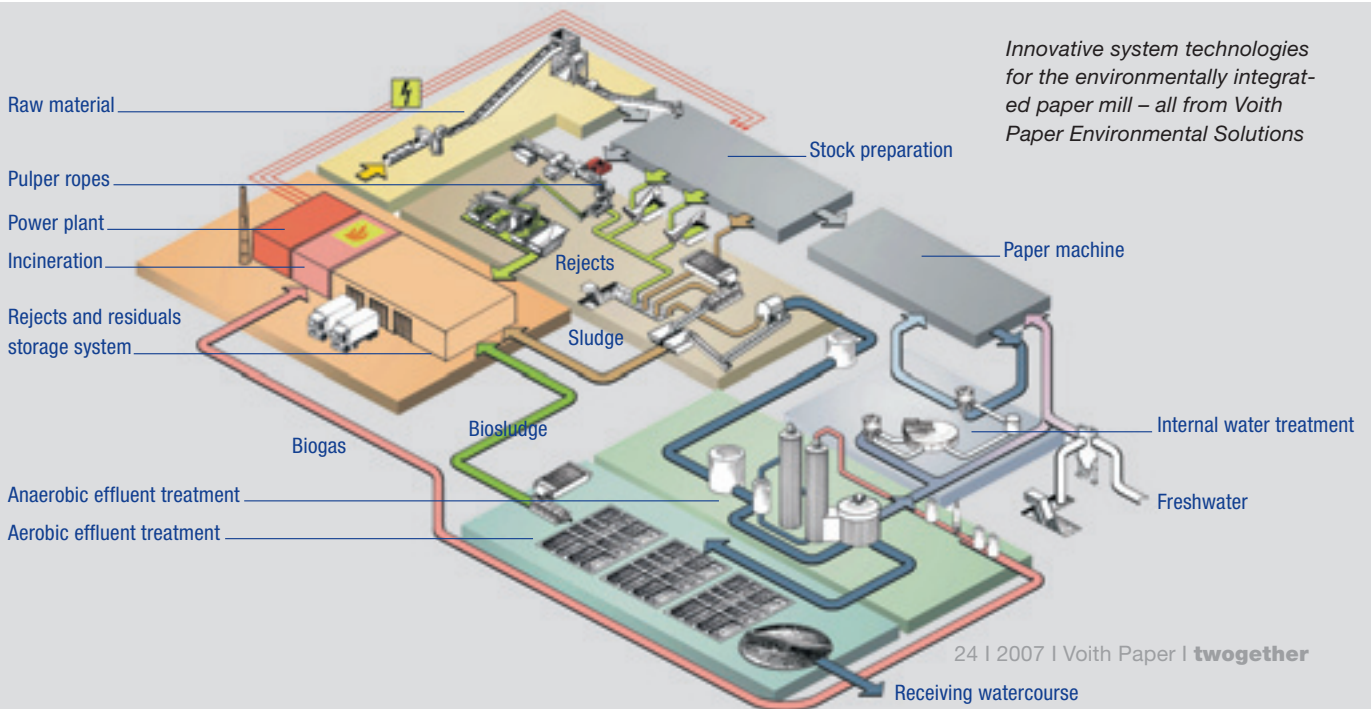

Paper industry facts and figures – advances in papermaking are driven by sustainability

Key paper industry figures

- Global forestry and paper industry output is worth around 750 billion Euro p.a.
- Worldwide paper production totals about 360 million tons from 8,800 mills.
- Global paper consumption averages 56 kg per capita.
- Most of the world's paper is produced in the EU (96 million t.p.a., of which 20 million t.p.a. in Germany) followed by the USA at 83 million t.p.a.
- Modern paper machines run at speeds of up to 2,000 m/min and can produce up to 1,000 tons of paper each day.

Sustainable development in the paper industry

Less water consumption

- Freshwater consumption in the German paper industry fell from 46 liters per kg of paper in 1974 to 13 l/kg in 1996. Water consumption per ton of chemical pulp produced fell by 75 percent from 200 to 50 cubic meters.
- German paper industry effluent fell in the same period from 46 l/kg to 12 l/kg.
- The average water consumption today is about 10 liters per kg of paper. Depending on the furnish makeup and paper grade, this figure can be reduced in future to 1-2 l/kg by means of external water loop purification using anaerobic biological methods and the "Lime Trap".

Less CO₂ emissions

- From 1990 to 2000, paper mills worldwide reduced their CO₂ emissions per ton of paper produced by 22 percent on average.

Better energy utilization

- Since the nineteen-eighties there has been greater use of waste materials (such as waste liquor, bark and fiber residuals) in chemical pulp production as fuel for energy generation.
- In German mills alone, production waste in paper production using recovered paper furnish amounts to 1.4 million tons annually. It costs more than 100 million Euros each year to dispose of this waste.
- Energy consumption fell from 820 kWh per ton of paper in 1955 to 295 kWh/t in 1998. This was attributable above all to the introduction of combined heat and power plants, greater use of waste heat recovery systems, more efficient mechanical dewatering, energy-saving drive systems, and higher machine efficiencies.

from 150 to 300 tons per day. And in parallel to the rise in energy prices, a new market has established itself for utilization of rejects and residuals as alternative fuel for generating heat and energy. The newly founded Voith Paper Environmental Solutions division in Ravensburg focuses precisely on this need.

twogether: Which technologies does VPES use for realizing the environmentally integrated paper mill concept?

Gebler: Together with well-proven B+G Material Handling technologies, and meri WSR subsystems – integrated system modules for internal water loop treatment, the clarification and reuse of waste water, and preparation of sludge and rejects – form a solid basis for further development. This technology portfolio is rounded off with an innovative technology for an-

aerobic effluent treatment as detailed in this edition of twogether magazine. The further expansion of our technology portfolio by innovations is ongoing.

twogether: What are the customer benefits of transforming rejects and residuals into alternative fuel?

Gebler: Until 2005, paper mills in Germany paid landfill fees of 30 to 50 Euros per ton of waste deposited. The new EU guideline eliminated that low-cost solution. Disposal cost rose to 100-130 Euro per ton. Reutilizing conditioned mill waste as alternative fuel not only eliminates these high disposal costs, but can also benefit customers through electricity generation.

twogether: Which concepts will VPES use for further closing water loops?

Gebler: Deposits due to the high lime content in loopwater influence the

production process and water treatment systems. Our newly developed "Lime Trap" technology efficiently controls this problem. That is an important requirement for recirculating anaerobically purified, solid free and decalcified waste water to replace freshwater.

twogether: Are there similar requirements in other industries?

Gebler: Waste and water recycling are global challenges affecting all branches of industry. Since nearly all the technologies we offer also have applications in other areas, we aim right from the beginning to market our innovations throughout industry.

With VPES we provide environmentally sustainable concepts for the paper mill, which conserve resources and generate savings for the customer.

*Mobile pilot reactor
on site at a corru-
gating board mill*



The anaerobic reactor – Setting new benchmarks in effluent treatment, even with high lime content

In the late nineties the European paper industry started significantly closing its water loops. Today, corrugating board machines are designed for about 4 to 6 m³ of effluent per ton of output, and some production lines operate with specific effluent quantities around 3 m³/ton or less. This ongoing closing of water loops places new demands on cleaning systems and process configurations, but also opens up new optimization potential through overall analysis and greater integration of peripheral effluent treatment in the process as a whole. Voith Paper Environmental Solutions is already setting new benchmarks with technical innovations in this area.

Effluent treatment technology in the paper industry has developed through various phases

With greater use of recovered paper and an increasing content of dissolved organic substances, biological effluent treatment had to be introduced on top of mechanical cleaning in the seventies. The first biological treatment plants were single-stage and purely aerobic. In other words: the effluent was cleaned by micro-organisms that needed air or oxygen for breaking down the dissolved organic substances.

In the eighties it was found that 2-stage aerobic treatment processes not only operate with greater stability, but also are less susceptible to objectionable gas bubble formation. To combat the increasing organic content in effluent, the next development phase was the introduction of anaerobic reactors. These break down a lot of organic materials already in the first treatment stage.

Corrugating board mills already used mainly UASB reactor technology (Upflow Anaerobic Sludge Blanket) at that time, when a specific effluent quantity of 8 to 10 m³/ton was typical for this grade.

The further closing of water loops led to significant concentrations of all the substances contained in effluent. COD (Chemical Oxygen Demand) concentrations in raw effluent today are around 6,000 to 10,000 mg/liter, with calcium concentrations of 600 to 1,200 mg/liter peaking to 1,500 mg/liter or more.

Current state of effluent treatment technology

State-of-the-art today for highly polluted effluent is 2-stage biological treatment. In the compact high-performance anaerobic stage (without air) 85% of BOD₅ (Biochemical Oxygen Demand) concentrations and 75% of COD concentrations are efficiently broken down. The aerobic stage only has to break down the residual materials afterwards. By reducing the amount of excess sludge, this concept minimizes expenses for

sludge treatment and disposal. And since the only air requirements are for residual breakdown in the aerobic stage, the resultant cost savings with today's energy tariffs are enormous compared with a purely aerobic system.

In an airtight anaerobic reactor, the dissolved organic substances (starch, sugar, alcohol, etc.) are decomposed to form biogas with a high calorific value. This can be utilized on site in a combined heat and power station to generate "green power". The net result of saving sludge treatment and disposal costs, drastically reducing aerobic treatment air costs, and generating power with biogas, is a rapid return on investment for the anaerobic stage.

Instead of UASB reactors, space-saving EGSB (Expanded Granular Sludge Blanket) reactors are used today for the anaerobic stage. That results in extremely compact installations. The new R2S reactor is a further development of EGSB reactor technology that meets the special requirements of the paper industry particularly well.



*Lime scaling on
sludge pellets*

High calcium content is another challenge to be met in effluent treatment technology: it can seriously affect performance due to scaling in the anaerobic reactor

Scaling due to high calcium content means that with large effluent quantities, tons of lime mixed with biomass are deposited in the anaerobic reactor every day. Furthermore, the spherical anaerobic biomass sludge pellets form around a limestone core up to 2 mm in diameter and can also have a limestone shell, known as the “eggshell” effect. The results are only too well known:

- Non-uniform fluidization of the pellet bed
- Undesirable deposits causing so-called “cold points”
- Formation of preferential flow channels
- Serious overload symptoms despite theoretically adequate biomass content in the system.

As a consequence, the anaerobic reactor performance declines so rapidly that it generally has to be shut down and cleaned out. Not only does this involve a production outage, but also the reactor has to be refilled with new active biomass.

The R2S reactor has no scaling problems

The new R2S reactor solves the problem of scaling that cannot be avoided by taking process technology and design measures. It does this thanks to the inflow mode in the reaction zone, internal flow streaming, and systematic dwell zones. Lime sludge and pellets deactivated by scaling can be removed without problem during operation.

By preventing deposits, the R2S reactor’s newly designed flow path ensures uniform processing over the entire reactor cross-section. Floating sludge layers are systematically removed separately from the system. Design measures have been taken to prevent air pocket formation at critical transition points, thus reducing lime precipitation potential.

The R2S reactor stays free of deposits and blockages

It is not possible in practice to entirely avoid problems due to erroneous drainage of surface-active substances into effluent, such as oil, retention agents and caustic soda. These problems include weir blockage at the reactor head due to uncontrolled pellet buoyancy. The necessary cleaning work at heights up to 30 m is not easy – particularly a challenge for the personnel during the winter months. By taking systematic design measures at bottleneck points with a high throughput of gas, water and sludge, or by using water flushing to assist sludge throughput, scaling and blockages in the R2S reactor are prevented and the circulating sludge is reactivated in good time.

The R2S reactor is flow-optimized for maximum space utilization

Another important feature of the R2S reactor is its innovative clog-free charging system. This distributes incoming effluent uniformly over the entire reactor cross-section area.



Weir blockage at the reactor head

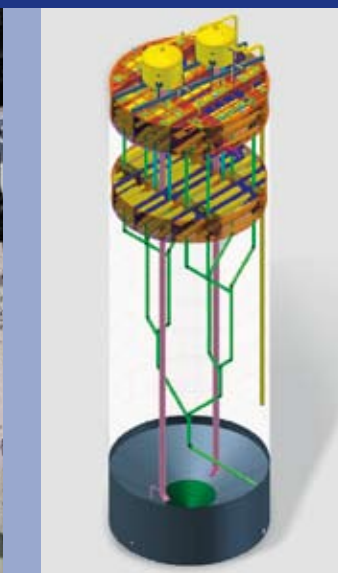

The new R2S anaerobic reactor (patented)



Full-size R2S anaerobic EGSB pilot reactor ready for the first installation

As a result, the pellet bed is optimally fluidized and much more of the sludge is actively involved in the decomposition process. The reactor performance is therefore optimized. Optimal pellet bed fluidizing is also assisted by external recirculation on top of the inherent internal recirculation. This ensures that even with very low effluent inputs, hydraulic upflow is adequate irrespective of inflow.

Our mobile full-size pilot reactor for further optimizing R2S technology is also available for customer tests

A pilot reactor (30 m³) for 600 to 1,000 kg COD/day throughput, housed in one 40-foot container and two 20-foot containers, is in use since May 2007 at a leading German corrugating board mill for full-scale

trials. The primary goal of these trials is to significantly raise the current limits on reactor capacity. With this mobile test facility, Voith Paper Environmental Solutions enables customers to carry out full-scale tests on site to assist their investment decision-making in borderline cases such as with low organic substance content.

Market launch of R2S reactor technology

In March 2007 a leading international supplier of corrugating board ordered the first R2S reactor for its Italian mill. This reactor has a diameter of 9 m, an overall height of 26 m and an effective capacity of 1,320 m³. It will process 38,000 kg/day of COD effluent, and commissioning is scheduled for autumn 2007.

Contact



Dieter Efinger
Voith Paper Environmental
Solutions
dieter.efinger@voith.com



Bowater Calhoun PM 4 rebuild – Realignment to more profitable markets

The declining demand for newsprint above all in North America is forcing papermakers to look for other ways of using their production lines. In many cases existing newsprint machines can be converted for producing other grades. This is often a very attractive option for increasing value-added – the secret of success in today's changing markets.



Bowater Incorporated headquartered in Greenville, SC, USA, is one of the leading producers of coated papers, specialty grades and newsprint. Bowater has approximately 7,600 employees and operates 12 pulp and paper mills located in the United States, Canada and South Korea. In North America, it also owns two converting facilities and 10 sawmills. Bowater operates six recycling plants and is one of the world's largest

consumers of recycled newspapers and magazines.

In 2003, Bowater and Voith demonstrated their successful cooperation when the Catawba PM 3 was converted from newsprint to LWC. This is the largest US machine conversion so far.

Bowater's Calhoun facility, built in 1954, is one of North America's

largest mills for paper from secondary fiber. The Calhoun mill is fully integrated on a site with five PMs in total, located next to the Hiawasse River, just upstream of the Tennessee River. The product range includes newsprint, uncoated paper from secondary fiber and virgin pulp of own production.

Annual capacity:

Newsprint	approx. 372,000 tpy
Specialty paper	approx. 372,000 tpy
Market pulp	approx. 145,000 tpy

Rebuild Objective:

BowHybrid FS paper production

The declining newsprint demand in North America makes it attractive for paper suppliers to convert their newsprint machines to products in greater demand and with more value-added. Whereas newsprint consumption is declining, direct mailing, catalogues and flyers are more promising markets with good outlook for future demands.

Adding more value is a key factor for success when market demand for your product decreases.

Bowater has long realized this, and, therefore, set clear targets for the PM 4 rebuild in Calhoun. These included precisely defined quality requirements for the new product, BowHybrid FS paper.

BowHybrid FS paper is a registered trademark of Bowater. FS stands for Freesheet and Hybrid means that this grade is made from mixed furnish comprising bleached chemical pulp and bleached TMP. BowHybrid FS paper combines high strength and bulk with a relatively low basis weight of 60-74 g/m² that, among other benefits, reduces mailing costs. Hence the marketing concept: "High bulk and lightweight with maximum strength". It can be produced either in the coated or uncoated form, because the hybrid furnish meets basic requirements both for brightness and improved opacity. With optimal calen-

dering, the uncoated paper already has excellent surface quality. Using a coating system could further improve printing ink yield and type character resolution.

Perfect Fit rebuild scope

Internal studies confirmed that Calhoun's PM 4 offered the most promising installed base for a successful and cost-effective rebuild. Voith's well-proven Perfect Fit strategy turned to be the optimal solution. Bowater's fiber base met all requirements for meeting paper quality demands.

Paper machine 4, originally supplied by Beloit Corp. in 1958, has a wire width of 7,112 mm, and was designed for an operating speed of 1,067 m/min and an output of 150,000 tons per year.

To convert PM 4 from newsprint to the same tonnage of coated hybrid paper, extensive upgrades were required. These upgrades included:

Calhoun PM 4 rebuild

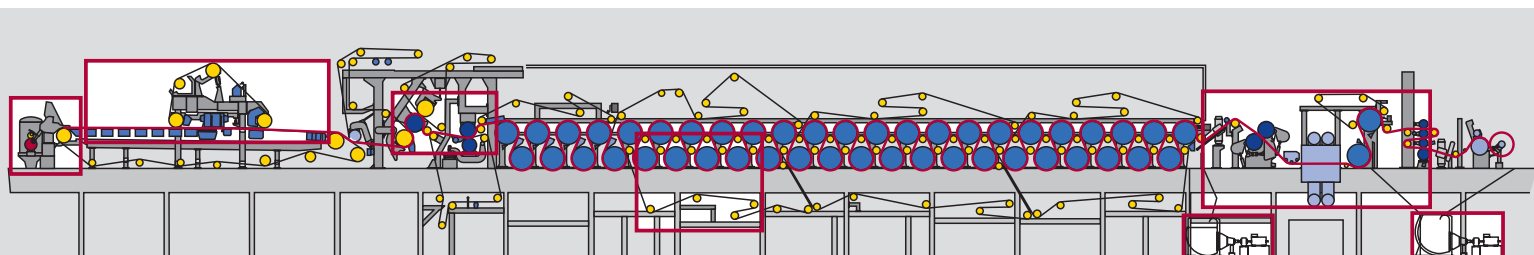

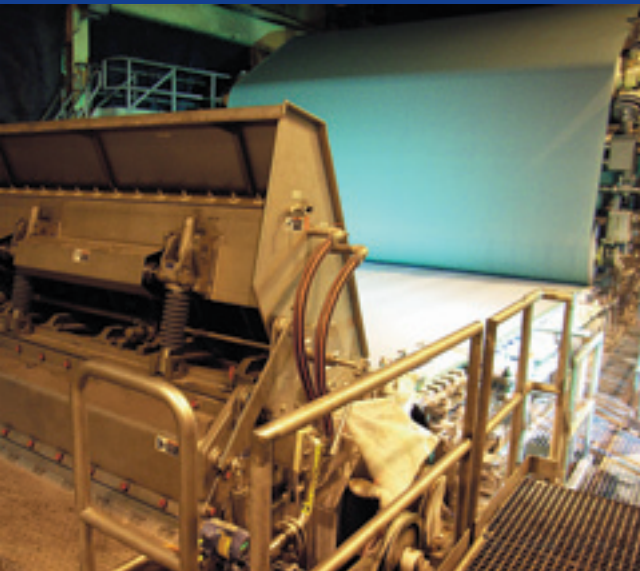

MasterJet II F headbox

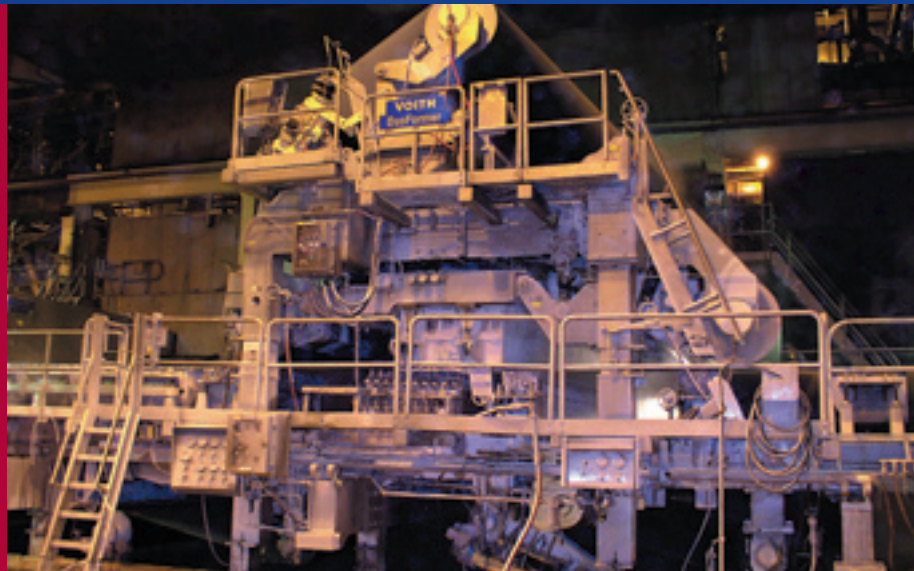

The new DuoFormer D

Customer Comment



Mike Cresswell
Bowater Inc.
Technical Assistant
Paper Mill

“We are very pleased to have chosen Voith as the equipment supplier for the grade conversion rebuild of Bowater’s PM 4 at Calhoun, TN. The equipment optimally meets our requirements and the Voith commissioning personnel was very knowledgeable. The start-up went very well, and we have already been able to run the machine at speeds and production rates exceeding the guaranteed values. Initial sheet quality parameters look good and we continue to get very positive feedback from customers regarding the quality of our paper.”

- Improved stock preparation line
- New headbox
- Major modifications to existing forming section
- Press and dryer section upgrades
- New coater station, including coating kitchen
- New after dryer section
- Modification of the existing calender.

In addition to the PM rebuild, Bowater also invested in a new bleaching plant.

Stock preparation

In order to handle production for the new hybrid paper grade, extensive upgrades were necessary to the stock preparation line for conversion to low consistency. These upgrades included new Voith MSA and MSS screens, new MultiSorters type MSM and a MultiDeflaker DF. For lowest gas content and, therefore, best paper quality, a new VoithVac de-

eration system was installed in the new Low Consistency line.

Wet end and press section

The wet end upgrade of the paper machine included replacement of the Beloit Concept III Converflo headbox with a state-of-the-art Voith MasterJet II F headbox with ModuleJet dilution water technology.

The existing Beloit Belform top former was replaced with Voith’s well-proven DuoFormer D. In addition, new foil boxes, a new TriVac suction box as well as new ceramic bars were installed in the forming table. With these changes, almost all elements in contact with the suspension/paper have been replaced.

The press section configuration was optimized for shorter draws and improved runnability. The granite roll was replaced with a modern ceramic roll. These modifications were de-

signed to accommodate the installation of a shoe press in the future. Runnability was further improved by installing a BubbleMaster suction box along with Fibron tail threading equipment such as tail diverters and peel & transfer foil units.

Pre-dryer section

Minor upgrades performed in the dryer section included converting one of the single tier groups into a double tier section to increase drying capacity.

Coating and after-dryer section

A challenging part of this rebuild, and a major key to success for Voith, was to identify and deliver a very economic solution by installing a SpeedSizer in the existing machine.

The Perfect Fit rebuild solution, and, therefore, the most cost effective, was to design the coater and dryer section in such a way that the exist-

ing calender and reel would not have to be relocated.

It was found that the existing calender location could be maintained if eight dryer cylinders were removed from the last dryer section and replaced by the SpeedSizer, CB turn system, air flotation dryers, scanner and the necessary paper rolls.

The last two dryers from the existing machine remained in their original position and became part of the new after-dryer section. This now comprises a combination of gas fired air dryers with two dryer cylinders acting as “pull group” ahead of the calender and driven by Voith drives.

Calender rebuild and winder

Extensive modifications were performed to the existing 6 roll hard-nip calender, which was converted into a 4 roll calender utilizing fly rolls to improve nip loading flexibility and eliminate the risk of wrinkles.

A new Voith GooseNeck parent roll changing system was installed to improve turn-up efficiency.

Results

Hardly more than one year after signing the contract on June 3, 2005, the paper machine was restarted on June 29, 2006. Within a very short period, PM 4 demonstrated its high potential and was ahead of the predicted start-up curve.

Within three weeks after start-up, the 3-month production target was surpassed, and within six weeks, the 12-month production milestone had been attained.

Continuing its high performance during the following months, the machine produced more than the budgeted production levels on various grades. In a very early stage nearly all performance criteria were fulfilled in close cooperation with the technologically well-versed customer.

The produced sheet showed excellent printing quality from the beginning, especially the coated paper product that has been well received by printers and advertising agencies alike. Furthermore, the market demand for this grade is continuously increasing.

Once again, Voith’s “Perfect Fit” rebuild strategy – single-source and fully coordinated – has resulted in complete customer satisfaction.

This rebuild ensured a highly successful launch for the BowHybrid FS paper marketing concept: “High bulk and lightweight with maximum strength”.

Voith Drive (patent pending)

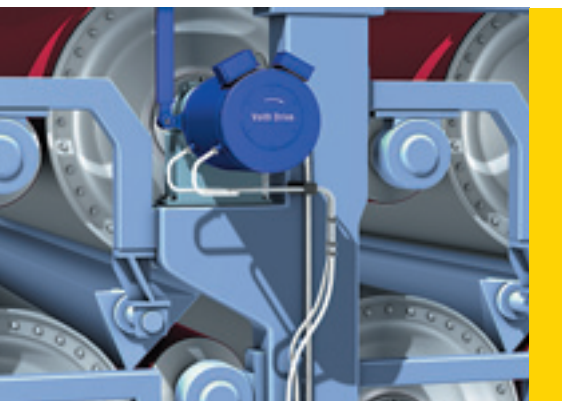

Contact



Martin Jauch
Paper Machines Graphic
martin.jauch@voith.com



ATMOS Premium Tissue – 35% energy savings and much lower investment costs

For more than 30 years, premium tissue was produced only by the largest tissue paper producers, using Through Air Drying (TAD) technology. Only they could afford the high capital investment involved and the high production costs mainly attributable to energy consumption. But the innovative Voith ATMOS technology has changed this situation. ATMOS technology was developed at the Voith Tissue Process Technology Center in São Paulo, Brazil in close teamwork with Voith Paper Fabrics. Thanks to this development, premium tissue can be produced at much lower investment and energy costs, also saving fiber and even using 100% recovered paper furnish.

We first reported on Voith ATMOS (Advanced Tissue Molding System) technology for premium tissue production in twogether 22. This joint achievement, involving innovation input from various Voith Paper Divisions, shows once again how much customers benefit from our

interdivisional synergies. The big advantage of this technology is that for premium tissue production it consumes 35% less energy than TAD and the investment costs are much lower. Depending on application, it also enables fiber savings and the use of 100% recovered paper furnish.



ATMOStissue machine

This is how ATMOStissue production technology works (see Fig. 1):

The ATMOStissue module is located between the former and the Yankee cylinder. Formation is in the same way as with a conventional crescent former, but the felt is replaced by a structured fabric known as AtmosMax (marked blue in Fig. 1). This en-

ures 3-dimensional sheet formation and carries the web all the way from the headbox to the Yankee cylinder.

A special vacuum roll, known as the ATMOStissue roll, ensures maximum dewatering. Water is mostly removed by the airflow (vacuum) and, in addition, optimally supported by intimate contact between the web and a newly

developed dewatering fabric, named AtmosFlex (marked yellow), that is installed between the ATMOStissue roll and the AtmosMax fabric.

Intimate contact between the web and AtmosFlex fabric is ensured by an air-permeable AtmosBelt (marked in red). This was specially developed to withstand high tensile loading, and

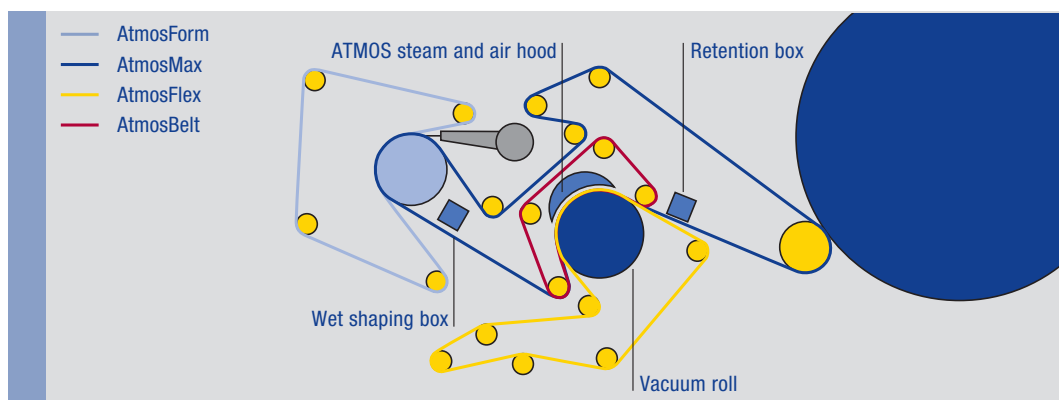

Fig. 1: The ATMOStissue operating principle (patented)

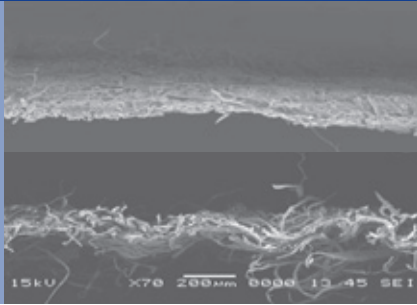

Fig. 2: Sheet structure of conventional tissue (top) compared with ATMOS (bottom)

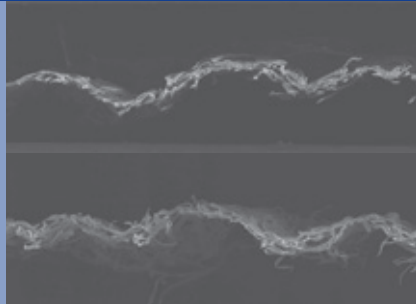

Fig. 3: Sheet structure of TAD tissue (top) compared with ATMOS (bottom)

is located above the AtmosMax fabric. Since it is not in contact with the web, the AtmosBelt has no influence on paper quality.

The ATMOS hood installed on the top of the ATMOS module provides additional heat by blowing hot air and steam. This results in a higher water temperature and lower viscosity accordingly, thus speeding up dewatering. The wet-shaping box in front of the ATMOS module intensifies the structuring effect of the AtmosMax fabric by vacuum application.

During web transfer to the yankee cylinder by a press roll, the AtmosMax fabric structure minimizes sheet compression to enable premium quality tissue.

To ensure perfect sheet transfer and uniform adhesion to the yankee cylinder surface, and for fine-tuned creping control with optimal runnability, Voith and Bruckman Laboratories developed Magnos coating chemicals.

Figures 2 and 3 show electron-microscope images of conventional tissue,

TAD, and ATMOS tissues. Figure 2 clearly shows the 3-dimensional structure of ATMOS tissue compared with conventional tissue.

As shown in Fig. 3, ATMOS technology attains the same 3-dimensional sheet structure at maximum volume as with TAD technology.

ATMOS production lines can be designed in 2,800 mm single width or 5,600 mm (double width). The ATMOS module is also ideally suitable for upgrading conventional tissue machines. Both conventional and premium grade tissue can be produced on ATMOS lines.

Depending on furnish quality, basis weight requirements and product specification, a double-width ATMOS line with a 5,500 mm yankee cylinder and a 500 °C hood can produce up to 200 tons of tissue per day.

Further information and operating experience with the first ATMOS tissue line will be reported in subsequent editions of *twogether* magazine.

Contact



Rogério Berardi
Voith São Paulo, Brazil
rogerio.berardi@voith.com



Thomas Scherb
Voith São Paulo, Brazil
thomas.scherb@voith.com



Ademar Lippi Fernandes
Voith Paper Fabrics
lippi.fernandes@voith.com

Greater value-added through improved cross-profile control

Everyone is talking about greater value-added these days, not only top managers. A recent international survey by PriceWaterhouse-Coopers among 17 paper industry leaders brought a clear verdict: the value-added chain must be further optimized. Voith Paper Automation aims in this connection to reach the point where paper machines automatically maintain optimal operation, thereby increasing value-added. The benefits of automation innovations are twofold: not only better paper quality, but also lower energy consumption.

In practise, optimizing value-added means finding the best compromise between maximum production output, minimum use of resources, and highest product quality. And that depends on how important each of these three parameters is for the customer concerned. Typically, more than 50 percent of mill operating costs are attributable to raw materials (35%) and energy (18%). So this is clearly where the most effective action can be taken, for example by reducing energy consumption and improving overall process cost-efficiency with automation systems.

Voith Paper Automation systems cover all aspects of the papermaking process. In terms of customer benefit, this means that you can depend

on Voith Paper as an overall system supplier highly competent to upgrade your existing machinery with automation systems. Voith is increasingly approached in this connection for optimizing paper machines, increasing their speed or reducing their energy consumption.

One such solution offered by Voith Paper Automation is OnQ ModuleTherm, controlled by OnQ Profilmatic software. Thanks to this technology the sheet thickness can be kept much more constant, with significant energy savings at the same time. A good example is PM 18 in Ruzomberok/Slovakia, producing copying paper for Mondi SCP. Voith Paper Automation used OnQ ModuleTherm here to reduce the thickness devia-

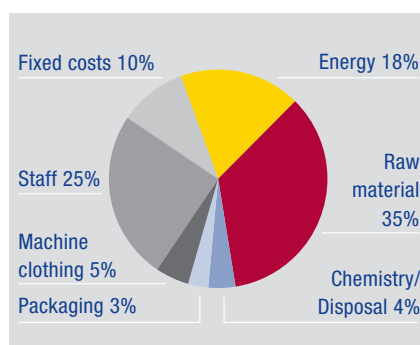

Typical operating costs in the paper industry: more than 50% attributable to energy and raw materials costs

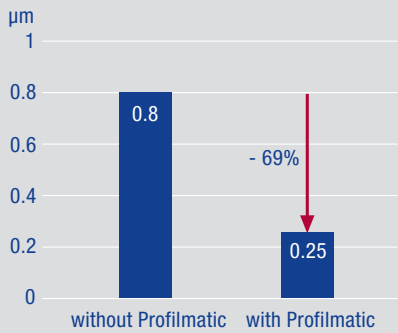

Ruzomberok PM 18 – Thickness cross-profile readings on the calender

Basis weight	80 g/m ²
Mean sheet thickness	104 µm
Line force	28-34 N/mm
PM speed	1,250-1,400 m/min

Thanks to OnQ Profilmatic, the thickness cross-profile (2-sigma value) on PM 18 in Ruzomberok was significantly improved

tion, already low at 0.8 µm (2-sigma value), by 69 percent to 0.25 µm – about one hundredth the diameter of a human hair.

OnQ ModuleTherm directs an air jet, which can be separately adjusted for each control zone, on to the calender roll surface. The different surface temperatures in the control zones

cause different radial expansions of the roll. These result in calender nip line force variations that influence the sheet thickness profile. Another way of varying the calender nip line force over the web width is by Nipcorect roll, whose hydrostatic support elements exert different pressures in each zone along the roll. Both OnQ ModuleTherm and the Nipcorect roll are controlled by OnQ Profilmatic software. By coordinating individual actuator adjustments in each zone, this software enables any desired thickness profile to be realized.

Each time an OnQ ModuleTherm is commissioned, Voith focuses on energy savings. To this purpose, a new solution has been developed where the actuator energy consumption is measured and automatically reduced

slowly until the programmed quality requirements are reached within certain tolerances. Using this strategy, energy consumption during the commissioning of a hardnip calender (in Ruzomberok) was reduced by about 70 kW. The resultant annual savings amount to about 600 MWh or 40,000 Euro.

This control strategy – that optimizes not only paper sheet quality but also profitability in terms of value-added – also applies to the OnQ Module-Steam blow box regulation system. Whether on DuoCentri presses, Tandem NipcoFlex or Single NipcoFlex – the innovative OnQ ModuleSteam control system guarantees a high dry content after the press. OnQ Module-Steam also optimizes the moisture cross-profile after the press for opti-

The efficient actuator control by OnQ Profilmatic software enabled improved paper quality, and lower energy consumption right down the line

OnQ ModuleSteam
Moisture

OnQ ModulePro
Moisture

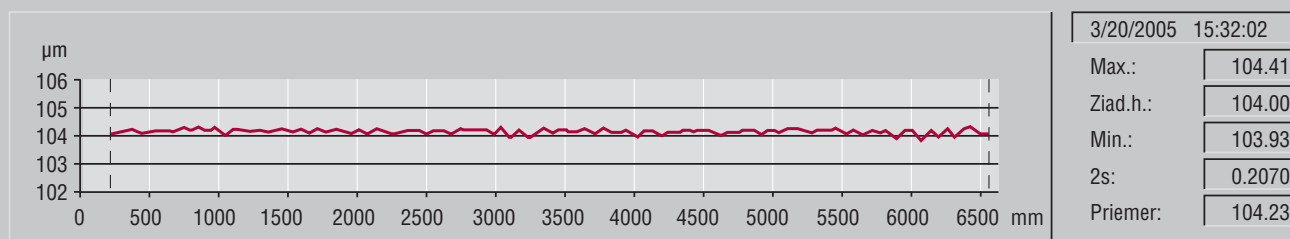

Using OnQ ModuleTherm and Nipcorect roll, both controlled by OnQ Profilmatic software, cross-profile thickness deviations were greatly reduced (Ruzomberok)

mal transfer to the dryer section. Together with the new control strategy, OnQ ModuleSteam automatically reaches the best compromise between optimal dry content and optimal cross-profile. And a higher dryness after the press means significantly less energy consumption for drying, which increases value-added.

Another way of increasing value-added by improving cross-profile control is the OnQ ModulePro nozzle moisturizer system. This ensures an ideal humidity cross-profile using state-of-the-art nozzles and valves, and is likewise regulated by OnQ Profilmatic control software. An OnQ ModulePro regulating valve with stepless high-precision adjustment moisturizes the web only as far as necessary to attain the required humidity cross-profile.

The optimized moisturizing system saves energy afterwards in the dryer section, and thanks to the better paper quality, the web run is also improved so that fewer breaks occur. OnQ ModulePro is, therefore, another important tool for optimizing value-added in papermaking. After installing OnQ ModulePro on Rheinpapier Hürth PM 1 newsprint machine in Germany, the quality improvement was nearly 80 percent – on a paper machine that was particularly demanding due to its high operating speeds.

As shown by these examples, with new automation concepts existing machines can now be optimized to realize their full value-added potential. These concepts not only optimize paper quality, but also significantly

reduce operating costs. An optimal compromise can thus be reached automatically between maximum production output, minimal resources consumption, and highest product quality. This can save mill owners 30,000 to 200,000 Euro per CD control system each year, without requiring any further production line investments.

Contact



Rudolf Münch
Automation
rudolf.muench@voith.com

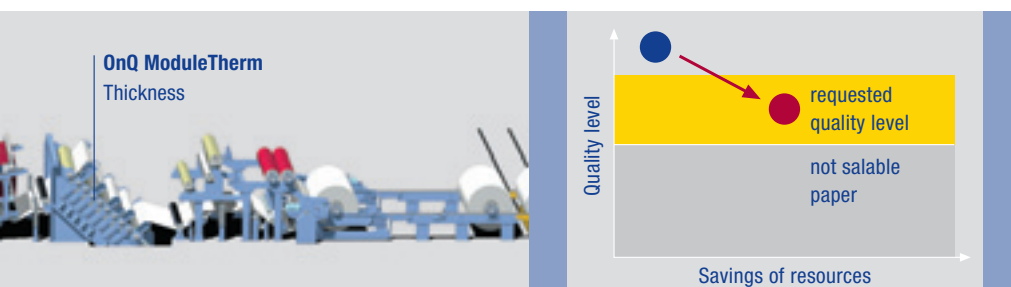

Energy consumption is reduced until the requested quality level is reached. This means greater profitability in terms of value-added



First Anniversary of the Voith Paper Technology Center (PTC) – Success through Innovation

Over the last few years Voith has launched numerous innovative products into the marketplace. The changing demands on research and development have led to reviewing and in some cases modifying the entire papermaking process, from stock preparation to finishing. There has thus been a radical change in R&D opportunities and challenges.

Voith met this trend by opening the Paper Technology Center (PTC) one year ago. Unique features such as a fully integrated fiber design facility and state of the art production loops, enable testing at the highest operating speeds and outputs. The most outstanding feature of the VPM 6 is however its modular machinery

arrangement. This features allow individual modules to be precisely arranged according to customer demands.

Twelve months of experience have confirmed the correctness of this concept: all our customers are highly impressed by the excellent practice



conformity of paper production at the PTC. For the first time, development work can be carried that would not be possible on conventional pilot facilities. Three different press modules – Tandem NipcoFlex, Single NipcoFlex and DuoCentri NipcoFlex – as well as the HiDryer, were used during the first 12 months at the PTC. This enabled our customers to compare machine concepts on a one-to-one basis for the first time. Finally, the most convincing evidence in support of the PTC concept can be found in the numbers, the pilot facilities are fully booked until the end of 2007.

The results achieved in terms of innovative developments are most encouraging indeed. That is why, starting with this issue, we will regularly report on new product developments which help to reduce investment or production costs and/or improve paper and board quality. In other words: innovations for the benefit of our customers.

The following articles briefly summarize some of these developments. The contact person for further information is indicated at the end of each article.

Contact



Ulrich Begemann
Voith Paper R&D
ulrich.begemann@voith.com



New speed record on the Voith PTC VPM 6 pilot paper machine – Over 2,000 m/min with Single NipcoFlex press

The VPM 6 pilot paper machine with Single NipcoFlex press at Voith's new Paper Technology Center has produced wood-free paper at 2,092 m/min – exceeding the world record speed for this grade by more than 300 m/min. “This test result puts us far ahead of today's state of the art”, according to the Voith R&D team.

This speed record is all the more impressive because it was achieved with only one press nip on a Single NipcoFlex press. The current production record is held by a paper machine with two shoe-press nips.

Targeted development by Voith Paper Fabrics helped to achieve this speed record by optimally adapting the press fabrics to the machine technology. Meanwhile, these press felts have been successfully introduced to the market. The entire clothing con-

cept for these trials, including forming fabrics, press felts, press sleeves and dryer fabrics was carefully selected by Voith experts for high speed and high paper quality.

An important advantage of this press concept is the closed web run, which ensures that even at the most critical points, such as in the first dryer group, web transfer at this record speed is no problem. Finally, the quality of the paper produced with 15% filler is impressive, with excellent formation, strength characteristics and surface properties.

Contact



Daniel Gronych
Voith Paper R&D
daniel.gronych@voith.com

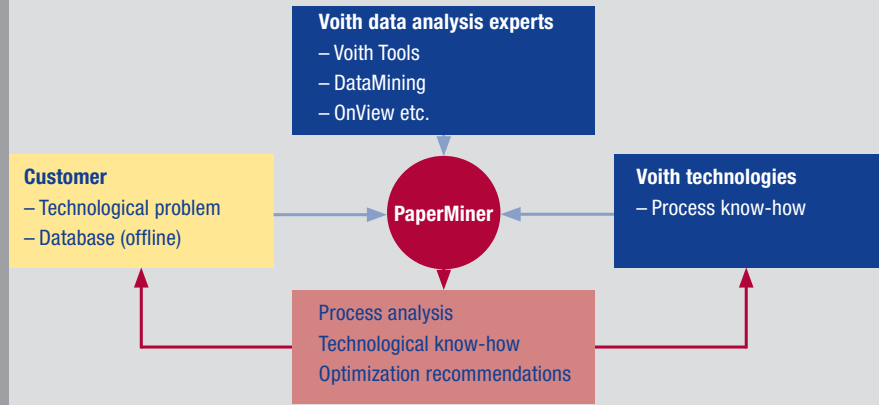
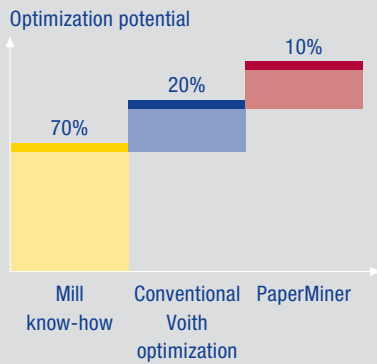

Process optimization, analysis and stabilization with PaperMiner – a service which turns database information into know-how

PaperMiner is a new Voith development that incorporates numerous useful services. It enables all the data collected during paper-making and finishing to be analyzed by various methods. However, this was not the only reason for developing PaperMiner: we want to give Voith customers the opportunity to turn all this data into new know-how in order to enhance their profitability.

This is a matter of process optimization, detailed analysis for a deeper insight, and stabilization of all steps in the papermaking sequence. A single figure is enough to give some idea of the data volume involved: more than 6,000 readings are continuously taken and stored during the paper-making process, some of them within fractions of a second. In other words, a Voith paper machine today incorporates more control system circuits than a modern jetliner.

Instead of leaving all this valuable data idle, it should be systematically

analyzed and utilized. PaperMiner evaluates ongoing process data using various algorithms, and supplies papermaking experts with hidden correlations between process steps. PaperMiner enables a much more comprehensive process analysis than was previously possible, allowing Voith experts to propose measures for more efficient and trouble-free papermaking.

Voith engineers regard PaperMiner as a way to exploit the last ten percent of optimization potential that cannot be utilized by conventional methods.

Contact



Dr Rainer Schmachtel
Voith Paper R&D
rainer.schmachtel@voith.com

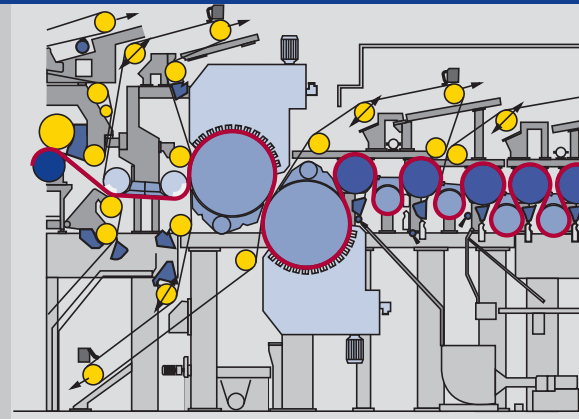
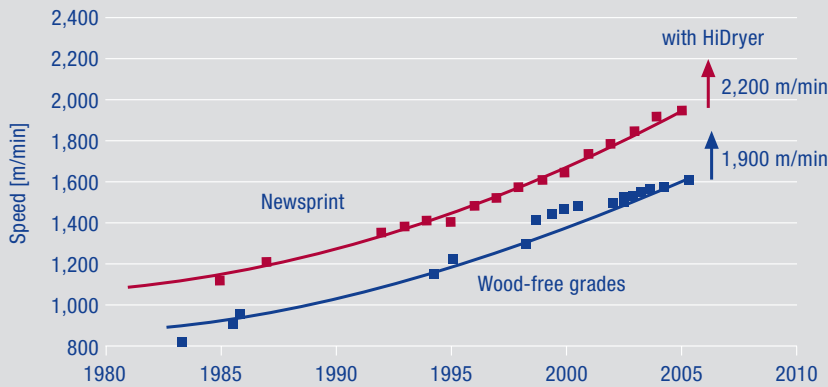

New speed record prospects – with the HiDryer

HiDryer – Impingement drying directly after the press (patent pending)

Innovative drying technology enabling speeds in excess of 2,000 m/min – HiDryer: the speed and quality module

One of the main goals of paper machine development has always been higher production speeds. Impressive advances have been made in this respect thanks to improved press technology, optimized felts for high solids content, and efficient stabilizers in the dryer section for reducing draws. But breaking the “speed barrier” of 2,000 m/min is only possible if the web already has a high solids content before entering the dryer section. And this is exactly what the Voith HiDryer makes possible. It is in fact a breakthrough development for wide and high-speed paper machines making them more profitable in the future.

As proven with the Hürth PM 1 newsprint machine, high quality newsprint can be produced at speeds in excess of 2,000 m/min. Further speed increases are however limited by the initial wet strength of the web, which dictates the maximum web tension that the wet paper can withstand after the press section. Excellent machine runnability requires adequate tension in order to release the web from the smooth dryers.

To attain speeds significantly higher than 2,000 m/min high web strength at the first dryer is required. The HiDryer ensures this by drying the web with high-performance impingement hoods to give it the necessary strength before entering the dryer section. In this way the HiDryer enables speeds 200 m/min higher than with conventional technology, thus making modern paper machines more productive and more profitable.



HiDryer facility at the Voith Paper Technology Center (PTC)

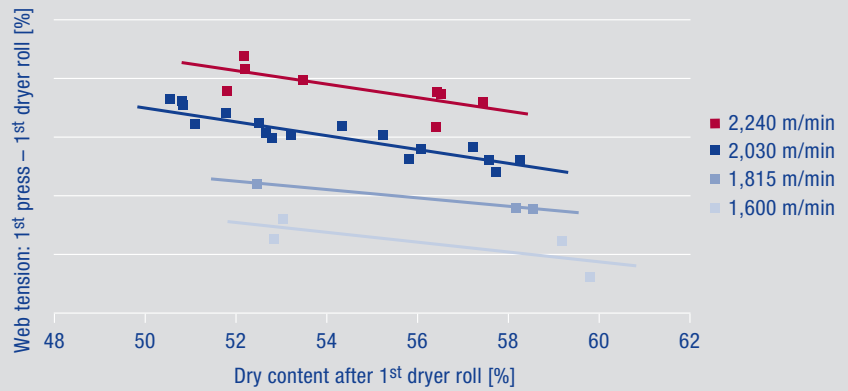

High-speed test results with the HiDryer

Efficient contact-free drying is ensured by using impingement hoods similar to those used for tissue production. Important here is that pure impingement airflow is applied but no through-air drying. The advantages of full web support, well proven in single tier dryer sections, are also utilized by the HiDryer. The web is guided safely and reliably by large suction rolls with stabilizers while at the same time ensuring an adequate drying surface area. Particularly important is that for any impingement drying directly after the press, the web has to be transferred over its full width to the first dryer, because this is the first possible location for the takeoff doctor. Here again, the large suction roll concept is well proven. There are no excess pressure pulses on take-up points, because no paper guide rolls are needed with this concept. Thanks

to adequate vacuum, the web is fixed rapidly and dependably to the dryer fabric and held on the HiDryer rolls during drying. Since fabric deflection is eliminated even under high vacuum, constant clearance from the drying hood is ensured. This is important, because even the smallest clearance deviations can cause undesirable moisture cross-profile variations.

The HiDryer was intensively tested for more than two years on the pilot paper machines in Heidenheim with great success, and is available at the Voith Paper Technology Center (PTC) for customer trials. Test results have confirmed the great potential of the HiDryer as a commercially viable drying concept. The offset printing results on paper produced at speeds of well over 2,200 m/min with this

concept are outstanding. All paper characteristics affected by dry content or web tension after the press can be improved with the HiDryer – for example the bulk of wood-free grades or the plybond strength and porosity of wood containing grades. All other paper characteristics such as opacity or optical properties remain unchanged within the normal range according to grade.

Contact



Roland Mayer
Voith Paper R&D
roland.mayer@voith.com



FeltView, an effective tool for press optimization (patent pending)

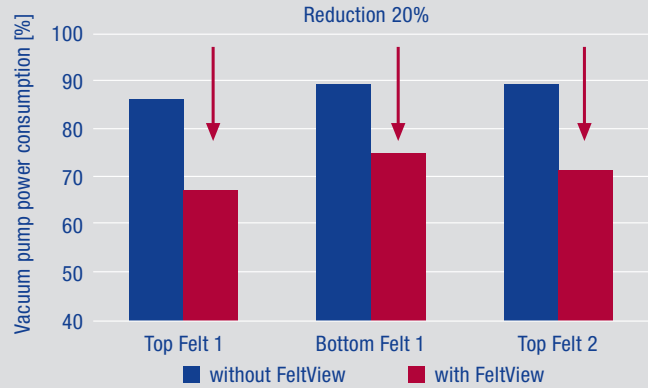

Energy savings potential with FeltView

Comprehensive know-how in pressing technology – The FeltView press felt analysis system

Voith FeltView provides a unique way of visualizing the interactions between felt status, conditioning devices and moisture cross-profile in the press. Results can be used for improving the moisture cross-profile and service life, and for significantly reducing energy consumption.

In a best case scenario energy savings of up to 20 percent can be achieved through the vacuum system. The FeltView system provides online traverse measurements of felt moisture content, permeability and temperature in all felt positions, thus enabling felt condition analysis and optimization at full production speed. The measuring head, traversing in the cross-machine direction, gently contacts the felt at fixed time intervals and takes continuous measurements during each cycle. The readings are displayed in the OnView portal and can be linked into all process and

quality management systems via the universal OPC industrial communication standard. Initial operating experience with FeltView has allowed previously hidden potential for optimal felt conditioning to be uncovered. FeltView-based felt management means conditioning precisely according to felt condition. This not only saves money and energy, but also increases process stability thanks to systematically planned felt conditioning. As an added benefit, press felt performance fault analysis is greatly simplified. FeltView is a step forward in day-to-day troubleshooting. By increasing

process transparency in the press section, FeltView enhances drainage stability and minimizes production costs due to wear and tear.

Contact



Ralf Pffferling
Paper Machines Graphic
ralf.pffferling@voith.com



Dr. Oliver Kaufmann
Automation R&D
oliver.kaufmann@voith.com

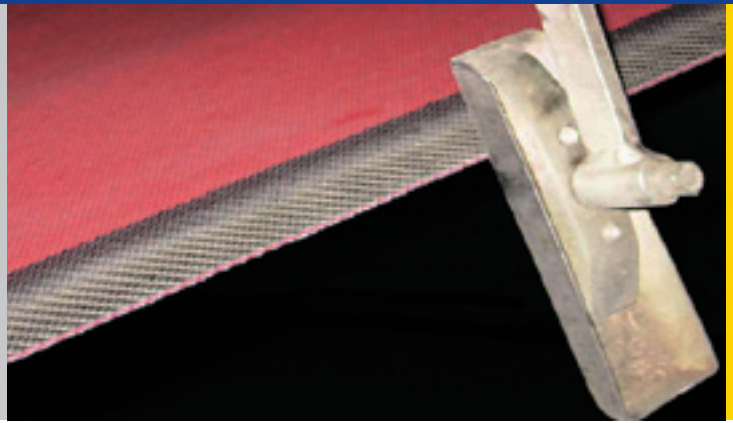
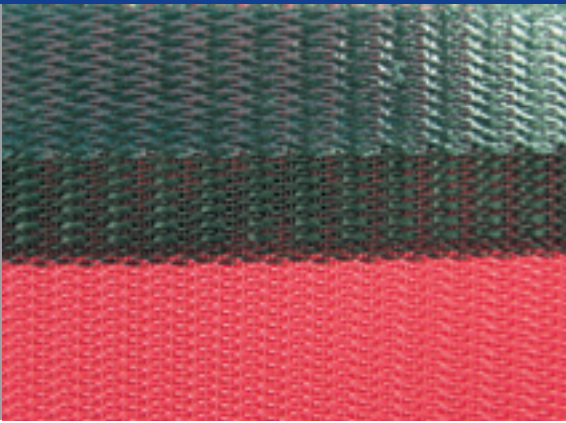

*Diamond Edge for Edge Wear Resistance.
Colour: Black, Width: 25-30 mm.
Position: On the edge in contact with guide spade
(patent pending)*

The heavy and solid Guide Spade is marginal adjustable and results in severe edge wear

New Engineered “Diamond Edge” for dryer fabrics – Lasts up to three times as long

Paper machine dryer screens have to operate under extreme conditions, due to mechanical forces, thermal influences and chemical effects. It is often the edges of dryer fabrics that are the most vulnerable.

Voith Paper Fabrics has developed a breakthrough engineered dryer fabric edge technology. Extensive technological research based on advanced high tech materials currently used in specialist applications, including the aerospace industry, led to a solution which satisfies the requirements set out above and in addition provides optimal resistance to abrasion.

Following intensive manufacturing trials, dryer fabrics with the new engineered edge technology were supplied and successfully trialed on commercial paper machines that have a particular history of fabric edge damage.

The results surpassed customer expectations. In one example the dryer fabric achieved a 300% improvement in running life when compared to standard fabrics. Positive customer feedback is generating multiple repeat orders and further interest in the market.

Contact



Antony Morton
Fabrics R&D
antony.morton@voith.com



Cheong Fatt Lam
Fabrics Operations Ipoh
cheong_fatt.lam@voith.com



ahead07 – Vienna Remains the Venue for Board and Packaging Paper Producers

“High Tech – Human Touch” – that was the motto of the fourth ahead Customer Conference taking place in Vienna from May 9 to 11, 2007. Around this topic, about 450 participants from 30 countries all over the world enjoyed a superb conference program. In this connection, man and machine turned out to be a highly interesting combination. The more you want to get out of a top machine, the more you depend on human factors.

In the beginning was the light
Wednesday, May 9, 2007
Semper Depot

Built as a storage space for the stage scenery used at the Viennese theaters, the Semper Depot has been the perfect setting for the opening scene of the fourth ahead Customer Conference. Every third year, Voith Paper invites its customers, partners, but also universities, research facilities and the trade press to Vienna to inform them about the newest developments in the board and packaging paper industry. The event is, of course, perfectly suited as a platform to foster friendships and develop new business relationships.

The spectacular and abstract opening show – a performance combining light effects and music composed specifically for the occasion – can hardly be put into words. At least, it helped to show the guests that an established mechanical engineer can also be modern and daring. After this brilliant beginning, Dr Hermut Kormann, CEO of Voith AG, gave a welcome speech to the guests. Even the six buffet stations were in line with the conference theme. Under the keyword “High Tech”, for instance, the guests were able to have a look at “molecular cuisine”.



Three blocks full of partnership, performance and innovations
Thursday, May 10, 2007
Hilton Hotel Conference Center

The two conference days were thematically divided into three blocks – the topic of “partnership” was handled first.

How is it possible that one customer reaches top performance while the other one remains on an average level with the same equipment? In his opening speech, Rudolf Estermann, Executive Vice President – Board & Packaging, discussed this question from several points of view. Since Voith delivers the same high quality to all its customers, it seem to be the human factors like cooperation, partnership, trust, and social influences that make the difference. But also hard facts, such as resource planning, technological consultation and the uncompromising dedication of both partners, play an important role.

Many interesting papers on the topic of “partnership” were presented during the first half of the conference day. Lars Mallasch, Vice President – Project Execution, for instance, talked about the increasing complexity, demanding a higher degree of professionalism in project handling. A paper machine may comprise more than 70,000 individual components and up to 4,700 inputs/outputs must function perfectly. Competence, know-how and working often under enormous time pressure are the name of the game for the technical and financial success of a project.

The growing complexity of machines also requires increasingly higher qualifications of the project managers,



Spectacular opening show

as senior project manager Helmut Riesenberger informed the audience. That is why Voith founded the Project Management Institute several years ago. This tailor-made training opportunity is also accessible to Voith’s customers.

Voith Process Solutions, PerfectFit, Process Line Package and Total Roll



Management are only some of the most important services and concepts that Voith Paper offers to the paper industry. Being a technology leader, it is Voith's top priority to find correct and perfectly tuned concepts meeting the customers' specific requirements.

The financial sector has also been discussed. According to Helmut Sieder, Vice President – Commercial Sales, Board & Packaging, tailor-made finance solutions are undoubtedly one of the tasks of a technology leader.

Top performance for a successful future

Technology is one of the most crucial issues for Voith. It is Voith's commitment to tackle its tasks in a systematic, realistic and ambitious manner. Jean-Yves Nouazé, Vice President – Process Technology, confirmed what Erich Brunbauer, Senior Vice President, had pointed out in the beginning of his presentation: Never let the customer down. Technology can also help to reduce risks. Board technologist Dr Torsten Paul told the interested audience how this works with the help of various tools, databases, on-site visits, etc.

When it comes to the runnability of the paper machine, a smooth and cross-divisional cooperation is of vital importance. Voith Paper is the only supplier who is able to develop and perfectly tune both paper machine and clothing. The advantages of this unique cooperation have been discussed in three presentations. Clothing design, felt and wire cleaning, as well as web stabilizing are an inseparable triad at Voith.

To ensure its technology leadership in the long run, Voith is highly dedicated to research and development activities. Dr Manfred Feichtinger, Vice President – Process Development, Board & Packaging, presented the various Voith Paper research facilities, as well as the innovation strategy of "Secure – Build up – Create", which is indispensable for such revolutionary solutions as the BoostDryer.

The paper industry is on the verge of entering the world of interactive training. Using EduCAT (Educational Computer Assisted Training), the customer will be able to simulate the use of a real paper machine.

The highlight of the first conference day was a high-level panel discussion. Moderated by Hannelore Veit – Anchorwoman of the Austrian Broadcasting Services (ORF) –, Carol Roberts (International Paper, USA), Dr Jan Klingele (Klingele Papierwerke, Germany), Jose Manuel Barroso (SAICA, Spain) and Ming Chung Liu (Nine Dragons Paper, China) discussed together with Rudolf Estermann.

Interesting talks about technical solutions

High-level panel discussion





Aperitif on the castle grounds



Closing dinner at the Orangerie of Schönbrunn Castle

Innovation is what counts

Friday, May 11, 2007

Hilton Hotel Conference Center

The guest speaker coming from Paris, Gérard Caron, the “High Priest” of design, took the participants on an interesting and – at the same time – amusing journey through the world of packaging design. Based on selected examples from Japan, USA and Europe, he showed the development and dependency of packaging design on our ever-changing way of life.

Smart solution must not necessarily be large. Voith has developed a wide range of “Product Solutions”. These small but mighty products guarantee maximum performance and several of them were presented by Martin Hubmayer as part of the “Performance” block in the morning of the second conference day.

One of the highlights of this second day was the presentation of the new field of Voith Paper Fiber Systems. Managing Director Lucas Menke presented the extensive portfolio of Voith Paper Environmental Solutions. The

board and packaging paper industry is particularly affected by high incidental expenses with regard to energy, waste water and the discharging of residuals. However, there is a huge potential in this field. Optimized subsystems are always a success, ranging from energy procurement through the reduction of discharging costs to the integration of the complete papermill. Voith Paper Environmental Solutions makes it possible and offers all the technologies and components required from one source.

The list of innovations was continued by Martin von Pawelsz, Area Sales Manager of Voith Paper Finishing. He presented the youngest sibling, the new VariSprint winder, reaching winding speeds of up to 3,000 m/min.

The closing presentations of the conference were reserved for the new products of Voith Paper Automation. Voith DriveCommand, Formation Sensor and EnergyProfiler are brand-new products that have been developed partly in a cross-divisional manner and that will exceed the industry’s expectations.

An evening with the Emperor

Whereas the first evening has offered an extraordinary and modern program, the closing dinner at the Orangerie of Schönbrunn Castle offered everything one may expect from a spring evening in Vienna. After taking the aperitif on the castle grounds, the guests took their seats at two 80-meter long banquet tables to enjoy an imperial dinner just like in the times of the Austro-Hungarian monarchy. Not even the Emperor himself would have been able to organize a more pleasant evening.

What remains is the memory of three wonderful days in Vienna, with interesting papers, innovative ideas, two delicious dinner evenings and – hopefully – thousands of ideas for the years to follow.

Contact



Helena Pirttilahti-Feichtinger
Marketing Paper Machines
Board and Packaging
helena.pirttilahti-feichtinger@voith.com



Christian Schrofler
Marketing Paper Machines
Board and Packaging
christian.schrofler@voith.com

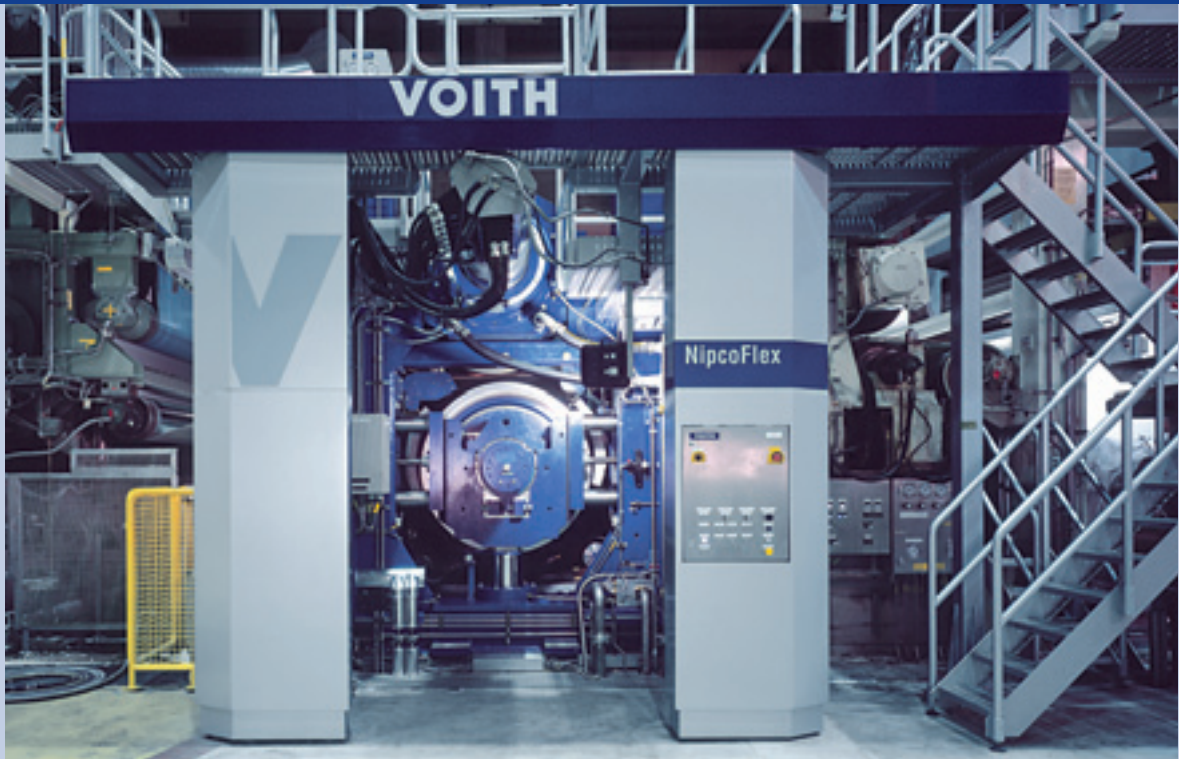

*NipcoFlex
calender in
operation*

Developments in board production – Trends on the global carton market

About 42 million tons of folding boxboard are produced worldwide every year. Growth rates are 2-2.5% p.a. in Europe and America and about 8-10% p.a. in Asia, where annual production currently totals around 10 million tons. Folding boxboard production in China rose 20% last year to about 3.5 million tons per annum.

The trend in liquid carton (LPB) production is also rising. With a volume of 3 million tons per year and annual growth of 5-6 %, China and South America are currently the fastest growing markets.

It is clear from these growth figures that particularly China is investing in new machinery, while production expansion in Europe is mainly through rebuilds and machinery optimization.

Different machine concepts in Europe and Asia

Folding boxboard is typically produced in Europe on multilayer four-drinier machines with MG cylinder, thickness control being ensured by a hard-nip calender located ahead of the coater. Depending on the smoothness and gloss requirements, a soft-nip calender may be used after double or triple coating. Asian machine concepts primarily differ with

regard to calendering technology, because in these countries there are practically no folding boxboard machines with MG cylinder. Instead, the base board is usually pre-calendered with heated hard-nip calenders. All grades of coated board, therefore, have to be post-calendered, for which soft-nip calenders are used.

This difference between European and Asian concepts naturally affects the finished board quality. European folding boxboard exhibits the best smoothness/volume ratio, which cannot be attained either with hard or soft nip calenders. While the smoothness of Asian folding boxboard is comparable with European products, the specific volume is lower because smoothness is achieved by heavy calendering and thicker coating, both of which negatively affect board volume.

NipcoFlex calender technology

The design concept and main components of the NipcoFlex calender

are based on the NipcoFlex press, installed so successfully by Voith on more than 300 machines so far. NipcoFlex calenders enable long dwell times and low line forces thanks to a press shoe that follows the contour of the heated backup roll.

A particular advantage of this concept is that speed increases do not affect the NipcoFlex calender, because the required dwell time can be set with the nip length.

This volume-retentive calendering technology enables comparable board quality at significantly higher operating speeds and lower stock consumption. Rebuilds of various kinds have shown that with the same dryer section length, capacity increases of 10 to 60 percent are possible without sacrificing board quality.

Compared with new production lines in Asia, most of which so far embody pre-calendering with a hard-nip calender, the NipcoFlex calender mainly offers savings potential in raw mate-

rial consumption. Up to 10% higher specific volume can be expected while reducing raw material consumption for the middle layer and increasing cost-effectiveness accordingly.

DynaCoat – the new coater concept

After Voith acquired the coating specialist Jagenberg Streichtchnik, the overlapping and widely scattered product portfolios had to be unified and reorganized. This has resulted in the new DynaCoat product family, comprising the AT and C coater types.

The DynaCoat C combines the advantages of all previous Combi-Blade and GL coater versions. It is based on the larger DynaCoat AT, but optimized for smaller web widths (up to 6 m) and slower speeds (up to 800 m/min) and, therefore, predestined for use in boxboard machines. The first application will be for a rebuild in China.

Scheme of NipcoFlex calender

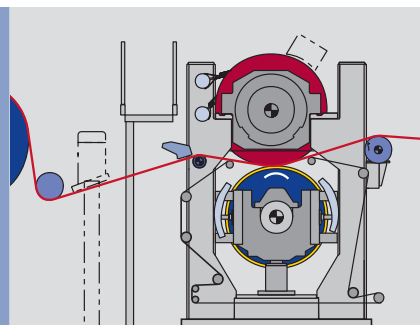

Comparison between MG cylinder and NipcoFlex calender

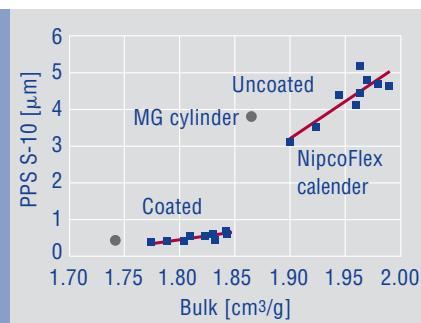

This new product family offers the following advantages (amongst others):

- No blade beam heating or cooling required.
- Modern safety concept, also enabling excellent coater accessibility and process monitoring.
- Optimally user-friendly maintenance and cleaning.
- Compact standardized control system concept, pre-wired and tested in the work shops. The pneumatic and hydraulic switchgear valves are machine-mounted.
- Minimal rebuild times for replacing outdated coaters; same dimensions as the CombiBlade coater.

DuoShake – significant improvement of multilayer board quality

DuoShake installations are already well proven on more than 100 paper machines worldwide. Thanks to its operating principle, this breast roll

shaker neutralizes reaction forces and enables significantly higher shaking frequencies than conventional machines. Much better formation is, therefore, attainable even at higher operating speeds.

Furthermore, the hydrostatic support principle eliminates almost all frictional and eccentricity forces acting on the foundations. No extensive structural measures are. Therefore, required.

Shaking may be required on one or more layers of multilayer board and carton grades. The DuoShake is ideal for this purpose, because it requires no concrete foundations and can be installed on a steel platform. Breast rolls on overhead fourdriniers can, therefore, be shaken without causing undue vibrations.

Not long ago this shaker's big brother was introduced: the DuoShake 600. Designed for heavy rolls on large

paper machines, the latest DuoShake with 600 Nm energy enables trouble-free breast roll shaking.

This opens up new application fields, such as for rebuilding existing lines with heavy steel rolls weighing up to 12 tons. One of the first applications of the new DuoShake 600 will be for a large rebuild in America.

Summary

Thanks again to various intelligent and innovative products, Voith Paper is now able to meet the highest board quality requirements by intervening at decisive points of the production process.

Contact



Christian Schrofler
Marketing Paper Machines
Board and Packaging
christian.schrofler@voith.com

DynaCoat AT

DuoShake (patented)



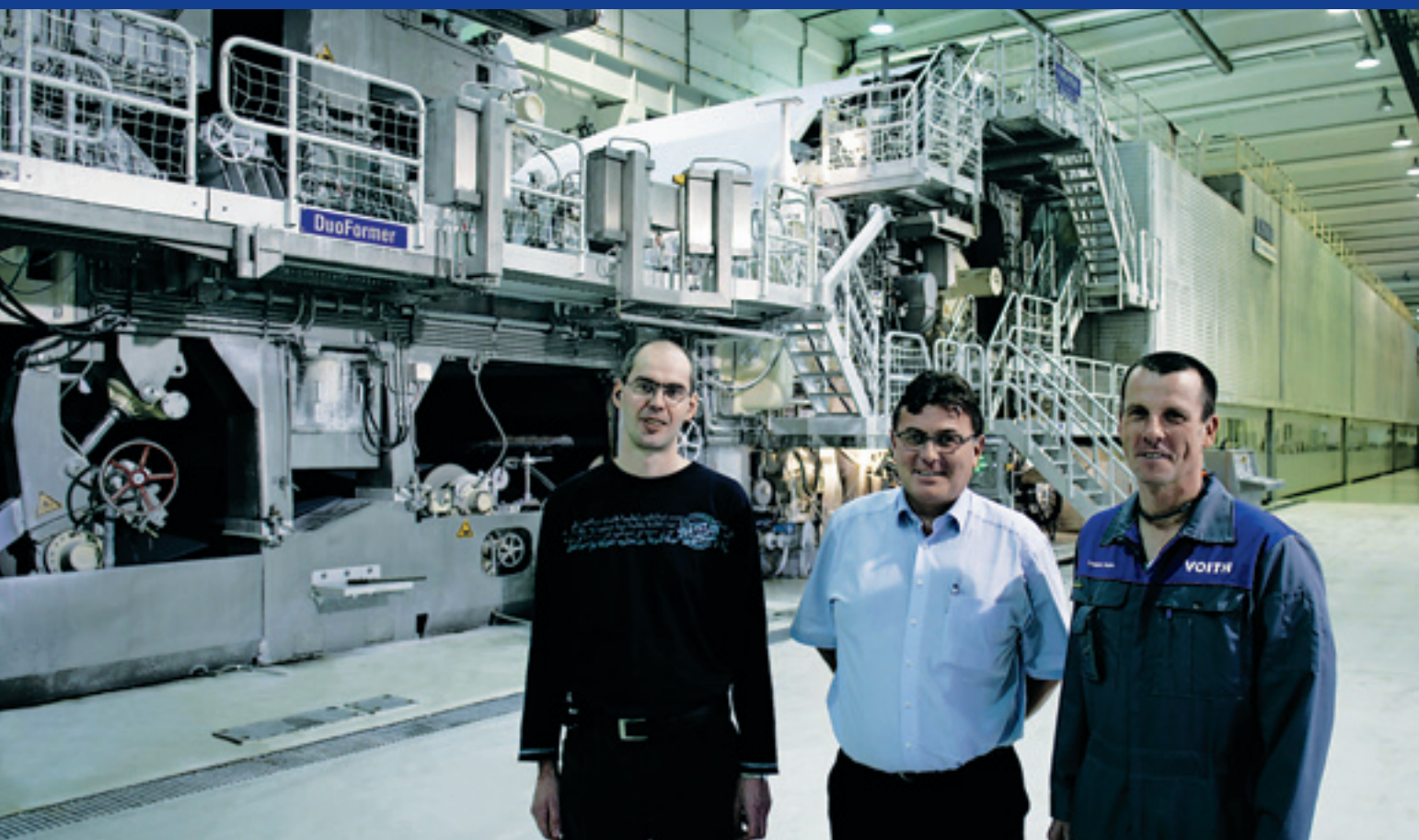

*Peter Demcak and Franz Aigner,
Ruzomberok, with Ladislav Vargic of
Voith Paper Fabrics (left to right)*

Mondi Business Paper, Ruzomberok – PrintTech LBR dryer fabrics improve efficiency

Papermakers are always trying to find ways of cutting energy costs and optimizing fabric performance. To this end Mondi Business Paper invested in 2003 in rebuilding their PM 18 in Ruzomberok. The rebuild mainly involved installing a new Voith Single NipcoFlex shoe press, plus DuoStabilisers and VentilStabilisers in the dryer section to improve web run and air circulation. Voith Paper Fabrics also cooperated with the customer to optimize the dryer section capacity and fabrics. Today this 6,500 mm wide paper machine produces 335,000 tons per year of copying paper at 1,500 m/min on average, using exclusively spiral dryer fabrics throughout the dryer section.

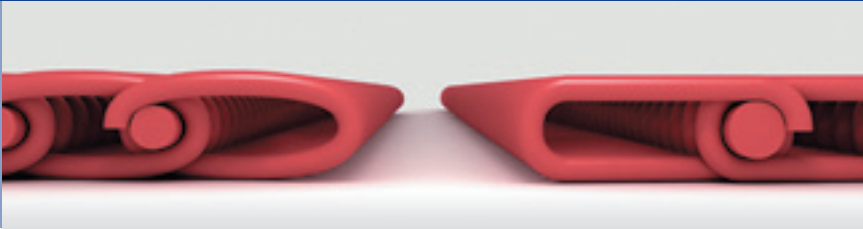

The levelling process shown on the right increases the contact surface area and resistance to abrasion

Ruzomberok, a town with 35,000 inhabitants in the hilly Zilinas region of Slovakia, has been involved in papermaking since the seventeenth century. Mondi Paper is one of the region's biggest employers and operates Slovakia's largest pulp and paper mill. In 2004, when various dryer fabrics of different makes and designs were in use, Mondi assigned Voith Paper Fabrics with efficiency analysis of the rebuilt dryer section.

The goals were as follows: improve drying efficiency, solve the web run problems, and optimize fabrics performance throughout the dryer section.

Improved drying

The following analyses were carried out in two days: drying efficiency, heat transfer (steam, cylinder surface and web temperatures), pocket con-

ditions, hood air conditions, hood supply and exhaust air, pocket airflow conditions, and web shrinkage. After shutdown, the machine and fabrics were then examined in detail to determine improvement potential.

The study of the dryer section showed a high specific steam consumption of 1.33 to 1.39 kg of steam/kg of evaporated moisture. Pocket moisture content amounted to 700 g/kg, thus reducing the evaporation rate.

Spiral fabrics with low air permeability normally have elliptical spirals. As a result the web is only supported on a few small contact points, which can cause marking and non-uniform drying. Voith Paper Fabrics, therefore, developed the levelling process for the PrintTech LBR spiral fabric with low air permeability. This increases the contact surface area on the web side, resulting in more uniform drying

and less risk in marking high quality paper grades.

Following the successful use of Print-Tech LBR spiral fabrics in the second and fourth single-tier dryer group (TopDuoRun) in May 2005, Voith Paper Fabrics spiral fabrics were installed throughout the PM 18 dryer section. The measurements carried out in 2006 showed improved drying rates, and reduced specific steam consumptions of 1.18 to 1.19 kg/kg. A higher evaporation rate with lower steam consumption brings energy cost savings, adding value from the dryer fabrics.

Improved web run

The dryer section showed high readings for inflowing air (negative values) on the wet side and high readings for outflowing air (positive values) on the dry side at the web edge. This airflow

PrintTech LBR spiral fabric

Energy savings achieved by replacing all dryer fabrics with PrintTech LBR

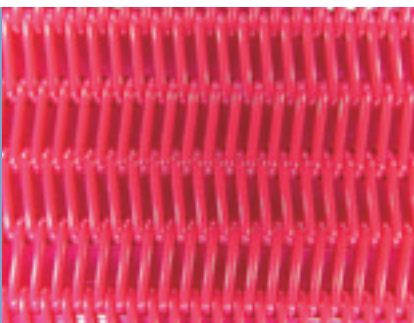

Date	Steam used (kg steam/kg evaporated moisture)	Evaporation rate (kg/hr/m ²)
29.04.04	1.33	24.25
21.04.05	1.39	23.06
22.03.06 PrintTech LBR on 70% of positions	1.19	26.92
24.10.06 PrintTech LBR on 100% of positions	1.18	27.15

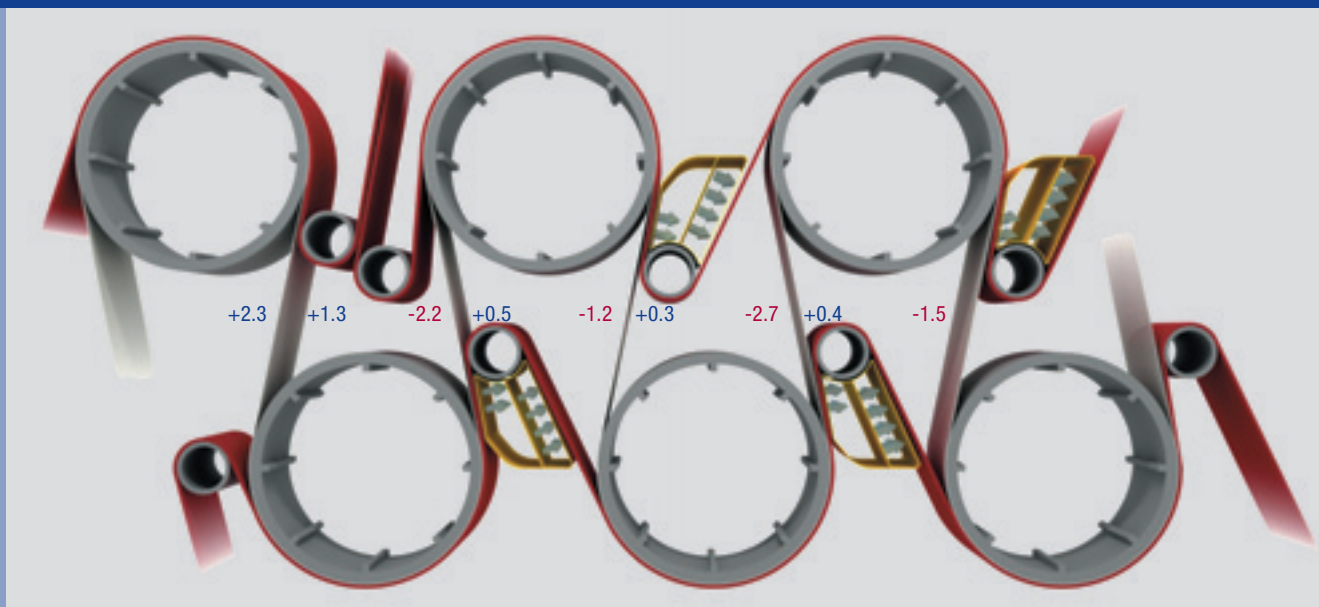

Imbalanced pocket airflows

imbalance in the pockets was due to using different fabric designs of various makes with different air permeabilities. Ideally, the airflow values should be about the same on both sides.

At the beginning of 2006 the dryer fabrics in this section were replaced with fabrics of the same permeability (200 cfm) to ensure optimal ventilation and uniform airflow conditions. Subsequent measurements showed lower inflowing and outflowing airflows, resulting in more stable web run with less sheet breaks.

Less risk of fabric damage

Fabric damage can be due to various causes. Sometimes paper debris gets caught between the fabric and machine parts, causing local stress peaks that lead to fabric tearing. The sealing strips on the web control

systems may have to be adjusted occasionally to prevent premature wear and tear of the fabrics. Paper debris from tail threading can accumulate, dry out and cause wear stripes to the fabric.

The levelling process improves resistance to wear because more material is at the fabric surface. PrintTech LBR spiral fabrics have an extremely high specific cross-sectional area of 42.55 mm² per 100 mm fabric width. This results in a stronger fabric and seams to improve resistance to damage.

Experience and know-how

Voith Paper Fabrics utilizes the paper-making know-how of all Voith Paper divisions, and combines it with applications technology know-how to optimize drying section efficiency and dryer fabric performance.

Contact



Ladislav Vargic
Fabrics
ladislav.vargic@voith.com



Graphic Packaging International – Promoting synergies through partnership

The three-year partnership between Graphic Packaging International and Voith Paper Fabrics has paid off in production gains for this leading maker of coated board. Superior teamwork – led by the mill's award-winning machine superintendent Jay Martin – has been a key success factor.



Graphic Packaging International in Macon, Georgia is a leading supplier of coated board for beverage packaging and folding cartons. Along with sister mills in Louisiana, Michigan and Sweden, the Macon mill supplies coated board to the company's converting facilities, which in turn provide finished packaging for some of the world's largest consumer product companies.

The company can be credited with innovative packaging designs, including the fridge vendor, microwavable cartons and Z-Flute® (zero flute).

The management team at Graphic Packaging Macon takes pride in the mill's outstanding safety record, quality production output and operating efficiency.

"Inflation has been a huge challenge for this industry and for this mill," said

Derek Hutchison, vice president and resident manager. "Natural gas goes into everything we buy to make coated board. We've done a really good job of offsetting inflation."

In fact, the mill has set records over the past three years in every category it measures: safety, quality, production, cost per ton, and financial performance. Hutchison credits this success to Paper Machine Superintendent John "Jay" Martin, along with Martin's efficient team of managers and operators, and value-added suppliers like Voith Paper Fabrics.

Award-winning machine superintendent

Jay Martin, who joined Graphic Packaging in 1993, was named the "2007 Brookshire Moore Superintendent of the Year." This prestigious industry award was presented at PIMA's

Graphic Packaging International in Macon, Georgia, is a leading global supplier of coated board



Jay Martin was recently honored as the 2007 Brookshire Moore Superintendent of the Year



(Left to right)
Wes White, Brian Garnett and Don Miller of Voith Paper Fabrics with Jay Martin and Derek Hutchison of Graphic Packaging International

National Awards Ceremony in March 2007. In addition, Martin is also a member of the Couch Pit University Fraternity, which recognizes individuals for their contribution to the advancement of papermaking science and technology.

Martin is a seasoned machine superintendent who is willing to take calculated risks in testing new technologies. The mill has benefited greatly from his ability to think beyond the obvious solutions and create new ways of utilizing technology and increasing productivity.

“Machines aren’t designed to break, they’re designed to run,” Jay Martin said. “I challenge my operators to push the limits. When we encounter obstacles that prevent us from running faster, it’s my job to recognize that. That’s when I’ll go to Derek, and we work through what is needed to

fix the problem. We’ve knocked down many of those obstacles.”

According to Hutchison, Martin is not one to accept traditional paradigms. “Jay is constantly seeking opportunities to speed up, improve quality and train operators. He gets others involved as well, like the people in the field and engineers at Voith.”

Voith has a significant share of forming, press and dryer fabrics on the mill’s two machines, as well as at Graphic Packaging’s Louisiana and Michigan locations. Graphic Packaging’s Macon mill has been an ideal partner in the development of new fabric technologies.

“With our current contract and relationship with Voith, we have the flexibility to collaborate closely, make design changes, and then trial fabrics on the paper machine,” said Hutchi-

son. “This has enabled us to really increase operating efficiency.”

Engineered surface enhancements through systematic fabric design

Graphic Packaging Macon was one of the first mills to work with Voith in the early stages of a new, engineered paper surface enhancement. Macon was interested because of the smoothness that could be achieved while maintaining the dewatering capacity and permeability attributes of a press fabric.

The product trial on No. 1 paper machine’s second press top fabric proved successful, but the mill wanted to take it a step further. They were looking to improve sheet quality and sheet bulk, as well as gain productivity. Martin worked with Voith’s Bob Crook in R&D and Brian Garnett,

Press Fabric Sales/Service representative, to develop a modified press fabric for a smoother paper surface. The new fabric has performed very well and is now the standard felt on this machine. A seam can be applied to the permeable structure, which enhances safety during installation.

“We’re really stepping up with advancements brought about by this new surface technology,” said Martin. “The goal for us is smoothness, so anything we can do to increase smoothness and not hurt bulk is what we shoot for. This had really helped us to gain bulk and reduce weight.”

The development work done jointly by Voith Paper Fabrics and Graphic Packaging will soon lead to the future introduction of engineered surface enhancements to the entire paper industry.

Multi-layer forming fabrics

As in the press section, the Macon mill has also seen improvements brought about by new fabric innovations in forming. The MultiForm GP and other multi-layer designs from Voith have performed well, even as machine speeds continue to increase. According to Wes White, Forming Fabrics Sales/Service representative

for Voith, these fabrics have improved drainage, speed and smoothness because of better fiber support. They have also proven to have a long life; the MultiForm GP ran on No. 2 paper machine’s top position for a full 363 days, a record for the mill.

Dryer fabric efficiency

In 2006, Voith Paper Fabrics began talking with Graphic Packaging about energy savings that can be gained through advanced dryer fabrics application and better air handling. The mill agreed to try a conversion from woven dryer fabrics to Voith’s Multi-Tech LAY link design. A full set of fabrics was installed on No. 2 paper machine during the annual outage.

Upon startup, the machine immediately achieved a significant gain in drying efficiency.

The Macon management team appreciates the value-added ideas that Voith has brought to the relationship. The mill also benefits from the hands-on approach of the sales and technical teams.

Don Miller, Voith’s Dryer Fabrics Sales/Service representative, is a constant presence in the mill, running weekly diagnostics to measure machine performance.

Teamwork pays off

Graphic Packaging’s Macon mill has seen a 10% increase in tons per day over the last few years with minimal capital investment. These production gains can be largely attributed to operating efficiencies, training and fabrics innovations.

Says Hutchison: “We give Voith a lot of credit for the fabric designs. The team is really focused on performance and finding ways to offset inflation through process changes and innovations. The forming fabric designs and the wet felts we’re running today have basically made No. 1 paper machine a new machine. We’re able to get the board quality attributes we need and not sacrifice speed. It’s really been a good relationship.”

Contact



Brian Garnett
Fabrics
brian.garnett@voith.com

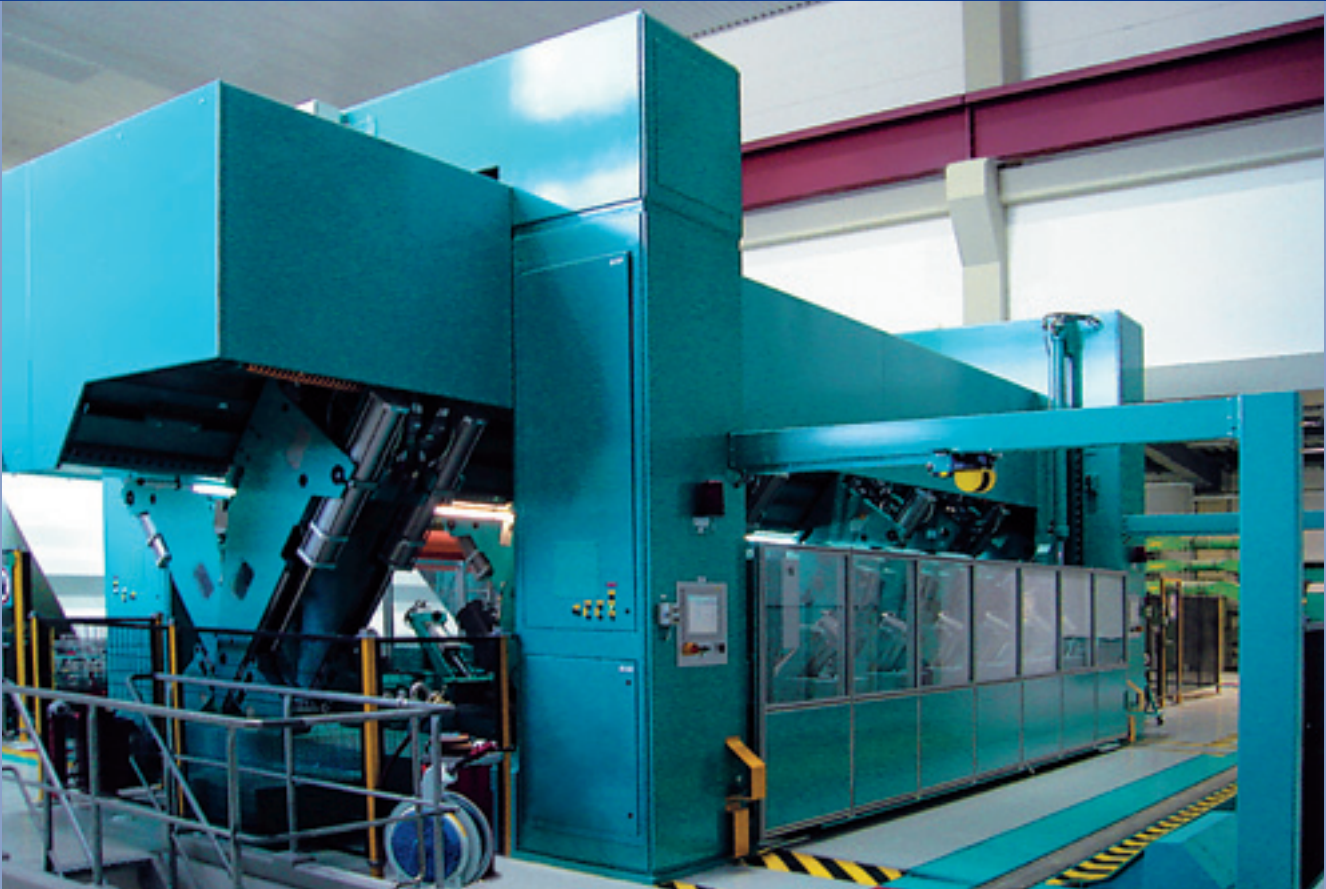

The VariTop winder at UPM Schongau (patented)

Preparing for tomorrow – Designed for the future!

Today we often find that what seemed impossible in the past is already reality. Even wide fast-running paper machines meanwhile rely on a single winder for their entire output. At the UPM Schongau mill, for example, a Voith VariTop single-drum winder handles paper of 6 meters width, produced on PM 9 which is running at speeds up to 1,700 m/min.

The high demands met by this VariTop are particularly impressive in view of the fact that while the paper machine operates at constant speed, the winder has to change four roll sets per parent roll. This intermittent operating mode places high demands on the machine dynamics and requires a high operating speed of up

to 3,000 m/min for the VariTop in Schongau.

To ensure dependably trouble-free winder operation, all components must be of the highest quality, and a modular automation concept is required. Dividing the highly complex automation system into clearly



VariTop winding stations operating at 3,000 m/min

organized and easily controllable modules is the primary requirement in modern machine control technology. Furthermore, comprehensive and dependable diagnostics functions are indispensable today. This means that most of the sensors and actuators must be automatically checkable for faultless operation. In addition, it is desirable have the automation structure harmonized within the whole

papermaking line. The Voith VariTop likewise takes into account all these requirements, based on the automation systems incorporated in the well-proven Voith One Platform Concept.

The Voith VariTop winder has been equipped with a completely revised automation system in order to ensure optimal dependability and high productivity accordingly. Both the hard-

ware and software components are now arranged systematically on hierarchically structured automation levels, with clearly defined horizontal and vertical interlinks.

Extended diagnostic is enabled by the E/A groups used. In combination with the Voith Library for PCS7, all components can thus be thoroughly checked for correct operation.

Automation levels for the finishing process

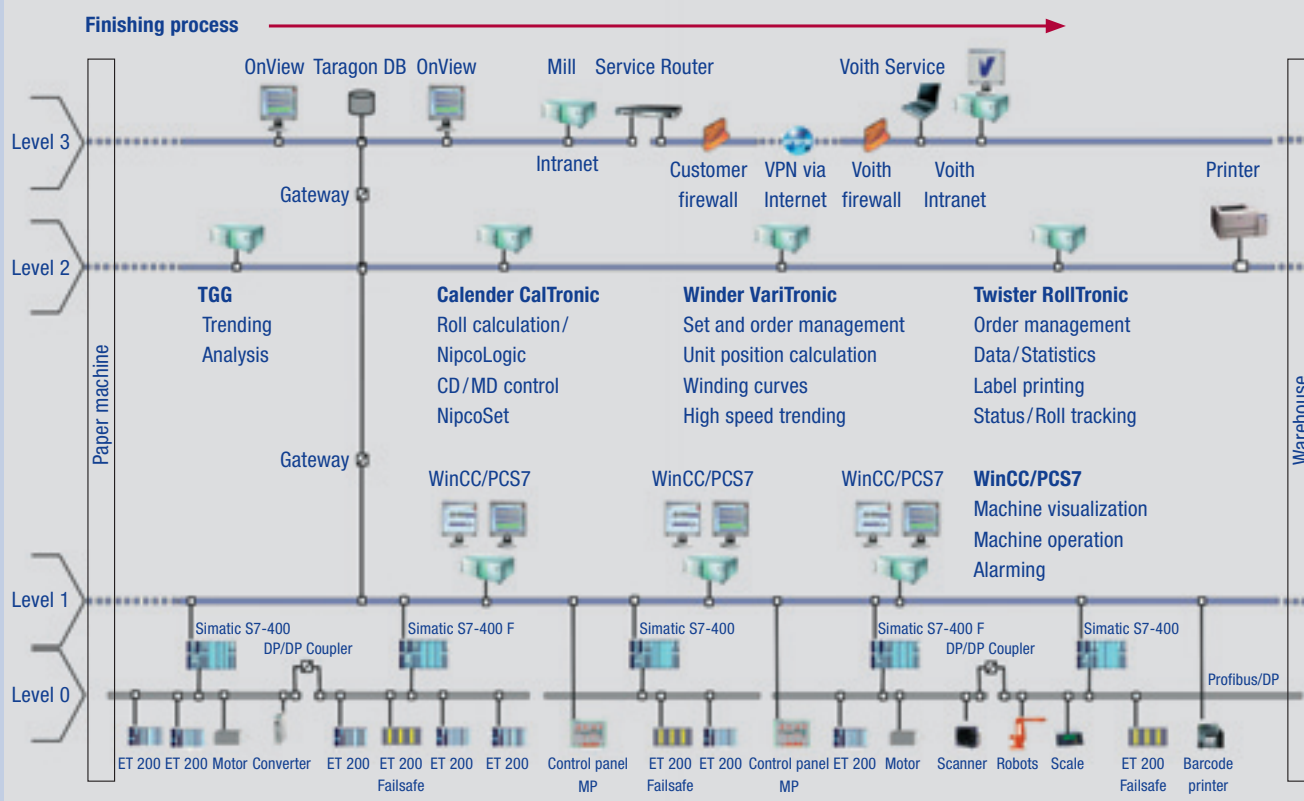

Without exception, all actuators and sensors are completely interlinked to enable full exploitation of the control system diagnostics capabilities. Even the VariTop's extremely precise positioning and control functions, such as knife positioning to one tenth of a millimeter, are directly linked with the paper machine control system. While computing is done by the process technology software modules, the sensors and actuators are controlled and monitored by the SPS.

The user control interface is based on the familiar WinCC system, with additional software modules enabling computing and monitoring tasks that go beyond the standard ones. All the complex machine functions are, therefore, visualized comprehensively, and,

based on the extensive data volume available, dependable and trouble-free operation is ensured.

Indispensable for the new VariTop automation concept was modular arrangement of the hardware and software components. Each component must fulfil its purpose perfectly, but also has a clearly defined interface for horizontal and vertical networking. Interactions between the components must be excluded, and no communication partner must be allowed to interfere with the timing and data throughput rate of the communication network. Meeting these key requirements has not only enabled practically trouble-free automation, but also forms the basis for future upgrade concepts.

Since – due to rapid technological progress in this sector – automation system components normally have a shorter useful lifetime than the machine itself, upgrading must be enabled by allowing for replacement in the future with more advanced and higher-performance automation components. By optimally exploiting ongoing improvements in automation technology, the VariTop can stay abreast of future demands for a long time to come.

Thanks to its modularity and hierarchical networking, the present VariTop automation concept is optimally prepared for the future. In view of today's rapid advances in automation technology, this is the only way of ensuring the longest possible pay-back on investment.

VariTop slitter section (patented)



Contact



Volker Schölzke
 Finishing
 volker.schoelzke@voith.com

NipcoFlex calender in coater SM 1 at Koehler Kehl



NipcoFlex Calender – a new means for crowning the finishing process

In spring 2006, Voith Paper successfully equipped two machines at the same time with NipcoFlex extended nip calenders: one at Weyerhaeuser Longview in Washington State in the U.S. for the production of liquid packaging board, and the other at Koehler Kehl in Germany for thermal paper. Before describing these two projects in further detail, one reason for this success should be mentioned and dealt with first, namely the Paper Technology Center, Finishing.

PTC Finishing

The basis of successful projects is the determination of the expected improvements in terms of product quality and/or product costs. Along with and as a complement to the Paper Technology Center (PTC) in Heidenheim, Voith Paper has also commissioned a new combined calender in

summer of 2006. Now it is possible in three stacks to calender paper or board on one or both sides with hard, soft, or shoe calender nips in any combination. Since the beginning of 2002, a considerable number of tests of various grades have been performed, from thin graphic papers with no more than 40 g/m² basis weight all the way to boards with a thickness of 800 µm.

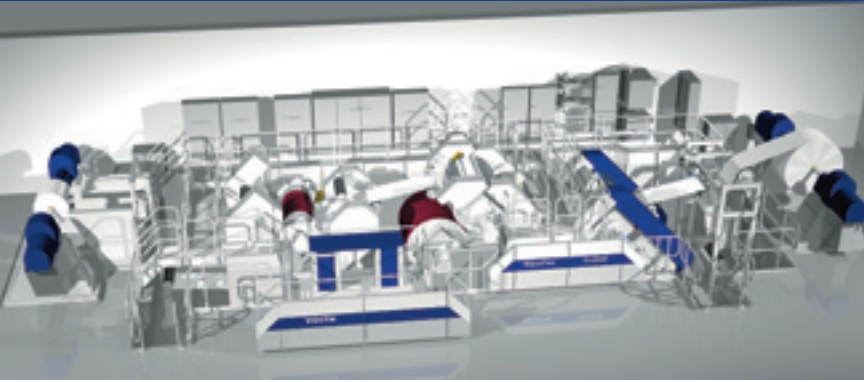

Combi-pilot calender at the PTC-Finishing

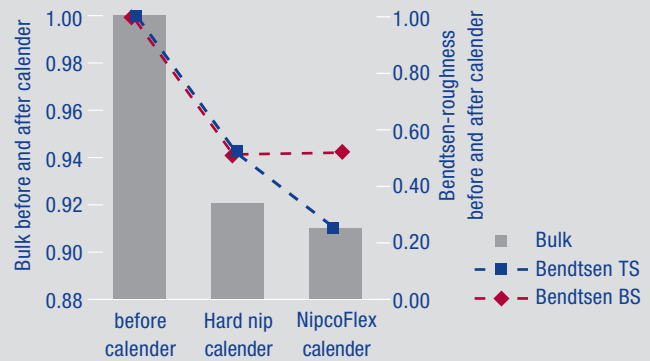

Smoothing the top and bottom side of liquid packaging board

In terms of technology, the NipcoFlex calender nearly always proves advantageous in the tests. In addition, the investment decision must also make sense economically. Two examples that meet these requirements are described in the following.

Weyerhaeuser Longview – from calender trials to success

Weyerhaeuser Longview wanted to replace its two wet stacks (multiple roll calenders with water doctors) with a modern calendering concept, consisting of a two-roll calender for the processing of the back side and for CD-profiling, and an extended nip calender for the smoothing of the top side. The main goals were to improve the correlation between surface quality and bulk and to increase productivity by means of a higher operating speed.

The first tests aimed to determine the operating windows for three grades of liquid packaging board. The goal was to optimize the start-up curve and achieve the objectives as soon as possible after the rebuild. Using DoE-software (DoE= design of experiments), the specifications have been met with the least possible expense.

Another issue that had to be resolved was whether the back side can be better calendered with a hard or a soft nip. The figure above shows results from the pilot calender. It illustrates how the individual processing steps affect the specific bulk and the Bendsen macro-roughness on the top and bottom side: In the first hard calender nip, the roughness of the paper bottom side that is in contact with the moderately heated roll decreases by almost 50%. Subsequently, in the NipcoFlex calender, this paper side touches the soft Qualiflex sleeve, and the surface quality improves only marginally. The roughness of the top side decreases by about the same amount in the hard nip and then considerably in the NipcoFlex calender to about only 25% of the initial value. What is interesting here is the development of the bulk. A loss of 8% occurs in the hard nip, while in the following extended nip almost no additional reduction occurs at all. This again confirms the advantage of the NipcoFlex calender; that is, it yields a soft and smooth surface while preserving bulk to the greatest extent possible. Thus, the development of the bulk significantly depends on the calendering method chosen in the first step. For this rea-

son, Voith recommended and installed a soft nip calender instead of a hard nip calender.

In addition to the improved quality, Weyerhaeuser Longview was soon able to realize further advantages: The number of dry end sheet breaks thus decreased remarkably, and a quicker web threading was possible. Moreover, the project is meeting the desired basis weight reduction plan. Overall, Weyerhaeuser now has a wider operating window and can provide better quality and higher stiffness without additional cost. The other option is to provide board with the same stiffness as before the conversion, but with lower basis weight.

Koehler Kehl – success off the beaten track

During the production of thermal paper, calendering is an essential, but often also a very limited process. Because a pre-reaction of the pressure- and temperature-sensitive coating has to be avoided under all circumstances, the coated paper can only be smoothed to a degree of quality just short of allowing this reaction to occur. This quality is usually already the minimum that the market requires.

	PPS vs. bulk	Bekk vs. bulk	Bekk vs. PPS	Surface structure	Reaction of coating	Print quality
2 rolls soft – hard	0	+	+	-	-	-
2 rolls soft – soft	-	-	-	0	0	0
NipcoFlex calender	+	0	0	++	++	++
	++ best	+ good		0 moderate		- worst result

Comparison of calender concepts
for thermo papers

Applying conventional means an additional increase is, therefore, impossible or extremely expensive, for example, by further improving the already costly coating pigment.

For this reason, Koehler Kehl first ordered the conversion of the soft nip calender into a calender with two soft rolls from Voith. Soon it became apparent that a shoe calender allowed for a further, significant improvement of quality due to its contour-adapted calendaring process. The table shows a comparison of the different calendaring types. A conventional soft nip yields fairly good lab test data, but in terms of the more practical characteristics such as surface structure (evaluated visually), pre-reaction of the coating layer, and printing quality, the NipcoFlex calender yields the best results by far.

Thus, it only made sense that after the successful tests Koehler Kehl was able to make a quick decision and placed an order with Voith for the installation of a NipcoFlex calender. To ensure that these technological advantages prove valuable under the tough, real conditions of daily production, several technical challenges had to be solved. For example, the

machine is operating at a speed far exceeding 1,000 m/min. A further main requirement of the customer was the trouble-free closing of the calender nip when producing a thin graphic paper at full operating speed. In addition, the cross profile of the paper should vary only within narrow bounds, and the sleeves must be designed for high durability despite the high pressure in the calendaring nip. From the start, all challenges have been taken care of, and the customer expectations have been satisfied to the fullest extent. The conversion indeed yielded positive effects both in terms of quality and production costs. The combination with the curtain coater installed by Voith in 1999 especially results in a beneficial process layout, which in turn creates a wider operating window. This provides Koehler Kehl with the possibility to further develop its products and offer its customers more tailor-made solutions.

The most obvious proof for the success of the project is the fact that even during the summer of 2006, Koehler Kehl also commissioned Voith Paper to install a NipcoFlex calender in the second coating machine.

Additional steps

All in all, the NipcoFlex shoe calender has successfully proven its potential in these applications. Thanks to the cooperation between Voith Paper's divisions, both projects have been completed with exceptional success. Both machines are working without problems and to the full satisfaction of our customers. In addition to the considerable increase in quality, both customers were able to realize significant improvements in terms of cost structure.

In the summer of 2007, the next challenge will be the commissioning of the second NipcoFlex calender with Koehler Kehl offering an even higher production speed. Thanks to our previous experiences we are sure we will be prepared to face this task. In addition, reducing operating costs will continue to be our aim, and Voith will achieve this with the further development of the Qualiflex calender sleeves we manufacture.

Contact



Dr. Jörg Rheims
Finishing
joerg.rheims@voith.com

High Technology on a Roll Part 2

Ceramics, polymers, elastomers and advanced composite materials have experienced considerable growth in paper machinery applications. In *twogether 23* the first part of this article reported on Voith research activities in this area. This second part now examines the subject in greater depth.

R&D Locations

The R&D Centers of Voith Paper Rolls are located in Wimpassing, Austria, and at the Research Triangle Park in North Carolina, USA.

R&D Projects

The R&D activities of Voith Paper Rolls are coordinated on a project basis, with cross-divisional projects with other Voith Paper Divisions. Global teams collaborate worldwide and meet the needs of market-driven projects.

All Voith Paper projects are accomplished by the Stage Gate Process. The development of roll covers or coatings is focussed on material science. Typical R&D steps for roll cover development may include, modelling, material development, material testing, development of manufacturing

technology and, finally, intensive prototype and field testing.

Modelling

In many R&D projects the first step is a theoretical model of the problem. This approach can help to better define the project goal or to shorten the practical development time.

One example for better understanding roll cover contact is a sophisticated computer program ("NipMaster") that was developed to predict the behaviour of our unique elastomer and composite materials when subjected to paper machine nip conditions. This computer program accurately analyzes various conditions found in paper machine operations. Therefore, this tool can predict stresses, strains, temperatures, heat fluxes, damping, and optimal flow rates for cooling (and analyze whether such cooling is

Finite Element Model of shear stresses in a roll cover

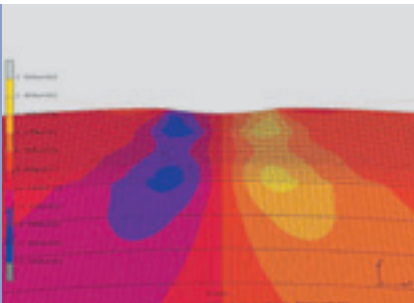

The R&D team in Raleigh, USA



Developing new materials to meet customer requirements



needed). The capability to rapidly and accurately analyze these variables in the cross-machine direction for matting covers of any property is unique in the industry. This program can predict failure modes of various roll covers under a variety of conditions (depending on temperature, stress, strain, etc.). It can be used, for example, to optimize the shape of the covers (crown) to obtain uniform paper properties, to avoid vibrations, or to analyze dewatering.

For the analysis of paper dewatering not only the press nip geometry or the roll cover surface but also the influence of the fabric is of prime importance. Due to this fact the R&D groups of Voith Paper Fabrics and Voith Paper Rolls are working closely together in order to integrate the highly specialized simulation for fabrics into an overall calculation tool model for the press.

Material development

Once the customer requirement has been properly analyzed, our material scientists start to develop the mate-

rial that can tackle the demands. State-of-the-art materials such as nanofillers and newly developed fiber and particle reinforcements are used for our latest innovations in the areas of press section, coating and finishing.

An example from the coating/sizing area is the development of StratoSize and StratoCoat covers. These highly sophisticated compositions are optimized to maintain the ground shape of the cover. The development goal was the minimization of cover wear under operating conditions. Special filler combinations with adaptation of the elastic matrix to suit those fillers resulted in an exceptional increase in abrasion resistance of this new cover series. The performances of the covers for the coating process were tested on the pilot coating unit in Voith Paper Heidenheim.

Material testing

The measurement of dynamic mechanical data is essential for development of roll covers for the paper industry. This is required because heat generation (by internal hysteresis) of

viscoelastic materials is a critical property that governs the maximum allowable load and speed of a cover and, therefore, influences its safe operation and ageing. In general, data is measured at various temperatures, frequencies and deformation levels, with a variety of time-dependent functions (harmonic oscillation, step pulses, etc.). The data is acquired by computers running software that utilize transform techniques to analyze the data. Currently several high technology devices are available at our R&D facilities to test the temperature-dependent, frequency-dependent and deformation-dependent properties of polymers used in roll covers.

Manufacturing technology

Seeking optimal manufacturing methods of different materials requires a continuous development of our manufacturing technology. A team of engineers is continuously working on modifications and development of new processes for new materials.

These engineers use their broad experience in cover manufacturing

Material testing



Mixing head of a casting machine for roll covers



Filament Winding





Roll-cover test stand

also for the technology transfers to all external manufacturing sites around the world.

Voith Paper Rolls invests continuously in new manufacturing technologies. Among these new technologies are e.g. a new Filament Winding Equipment for manufacturing composite rolls, the latest thermal spray equipment, and new proprietary processes that were introduced to establish higher process reliability and better quality control.

Chronology of innovation

The development of exclusive/unique manufacturing technology allows unique product design.

Prototype testing/field trials

Since reliability of covers and coatings is essential for acceptance in the paper industry, durability and loadability of the covers are tested on custom-designed roll test rigs. In these test runs, the covers are run to their limits, thus enabling Voith Paper Rolls engineers to precisely define the allowable stress, strain, speed and temperature of our covers in operation.

In these pilot units as well as in the new Paper Technology Center, the newest roll covers are available for paper mills to run paper technology trials. The final test runs before market introduction are performed in selected field trials together with customers and R&D personnel.

The introduction of our products to the market is accomplished in the last Stage Gate step with intensive involvement of Marketing, Product Management and Sales.

Outlook

The challenges of a fast developing paper production technology and the trend to more efficiency and speed will be met in the future only with a highly customer oriented, market and technology driven R&D organization.

For this purpose new scientists and technicians have been hired to increase the expertise and focus of our R&D activities. Voith Paper Rolls R&D will also focus on new technologies in the areas of real-time sensing and automation, and development of new materials as well as new process developments.

Contact



Dr Norbert Gamsjäger
Rolls
norbert.gamsjaeger@voith.com



Dr José Rodal
Rolls
jose.rodal@voith.com

1984 Kernethane HT/KT	1987 SuperTop	1988 TopRock	1993 TopTec Serie TopCoat HP TopSize HP	1995 CeraLease AST cohesive bonding system PolyDyne SR II	1997 Aqualis Dewatering Technology PolyDyne	1998 G2000	1999 Safir Rubin CaTek T-Master Magna Serie	2002 Center-Supported Roll TopSize HPX TopCoat HPX	2003 Vantis S CeraLease SDe StratoSize StratoCoat	2004 Vantis SC StratoPress	2005 VRG	2006 Vantis M TerraSpeed Solar Generation EndurAll PikoClean NG	2007 SkyLine CarboTec 3DG NipMaster NipSense
------------------------------------	-------------------------	------------------------	---	--	--	----------------------	---	--	--	---	--------------------	---	--



New Thermal Spray Coating production line started-up in China

In February 2007, Voith Paper Rolls China started up successfully a state-of-the-art thermal spray coating production line for rolls and dryer cylinders at its Dongying plant in Shandong province.

In May 2003 Voith started to serve Asian papermakers with high-end roll covers, mechanical roll services and regrindings out of Kunshan plant, located in Jiangsu province, and Dongying plant. Since start-up of the two service centers in China a team of 150 members manufactured more than 1,200 rolls covers and ground more than 2,000 rolls for the Asian paper industry. Continuous investment in new equipment and technology to offer new value added to the Asian papermakers is one of Voith Paper Rolls China's core business strategies.

With the realization of the recent important strategic investment in February 2007, Voith is now in the position to serve Asian papermakers with high-end thermal spray coatings and shortest turnaround in manufacturing times.

The thermal spray coating investment has been realized in close cooperation with European technology specialists and machine suppliers. Thus a modern and efficient production line, based on latest developments in coating technology, which fulfils in addition highest work environment

Grinding of a CeraCal Plus roll cover



Thermal Coating

protection and safety standards, has been successfully realized. Both Plasma coating for ceramic covers and the HVOF coating process for metal alloys coatings are now available in Dongying.

The thermal spray coating production line is designed for rolls with a maximum face length of 14 m. The project included a building extension of 500 m² manufacturing area plus 200 m² laboratory and office space. Additionally, the roll grinding capacity was increased by a new grinder and a second crane was installed.

Voith is now offering out of its Dongying plant a wide range of thermal spray coatings that are matching the

papermaker's needs for rolls with superior running performance, compared to non-coated rolls, for different paper machine application positions. For suction rolls in the wire and press section, extremely wear resistant CeraVac coatings offer a significant increase in running time.

TerraSpeed for center press rolls is the latest generation of ceramic coatings, which lead to uniform sheet release and a lower draw. Thus sheet breaks can be reduced significantly.

High wear resistance CeraVent coatings are leading to a significant increase in running time for grooved press rolls.

*The Donying team –
competence for
high-quality roll covers
and roll service*



*CeraGuide Plus
roll cover*

In the dryer section CearDry and CeraGuide Plus coatings with superior anti-sticky properties are significantly reducing fine fiber sticking on dryer cylinder surface, thus better paper sheet release and decrease in draw can be realized.

CeraCal Plus thermal spray coatings for the hard rolls of soft calender, multi-nip calender, and super calender, with their superior wear resistance properties, offer low surface roughness values during the entire running time. The need for roll change and re-grounds is decreasing, and the running efficiency of paper machines and off-line calenders is, therefore, significantly increasing. The above mentioned thermal spray

coatings are only examples out of the thermal spray coating portfolio offered by Voith in China.

Since start-up of the new thermal spray coating production line, several important orders have already been delivered to customers. In March 2007 one CeraGuide Plus roll for APP Dagang PM 3 and in April 2007 one 10 m face length CeraCal Plus cover for APP Dagang PM 3 Janus calender were manufactured. This is the first roll out of a package order of four CeraCal Plus coatings for APP Dagang. Tjiwi Kimia, Indonesia, (PM 11) and another Chinese paper producer placed orders for TerraSpeed ceramic coatings for their press rolls. These TerraSpeed coatings were delivered

in May and June 2007. Several dryer cylinders were coated with CeraDry Plus and have been delivered to customers.

With the successful realization of the thermal spray coating production line Voith Paper Rolls China has enlarged its cover portfolio and again proves its commitment to be the competent and reliable partner for high-end roll covers and services for the Asian paper industry.

Contact



Stefan Dette
Rolls
stefan.dette@voith.com

Total Roll Management – The Ultimate Roll Service Concept

The performance and reliability of rolls have a huge impact on paper quality and mill profitability. The Voith Total Roll Management (TRM) concept is the ultimate tool for all papermakers to achieve the best roll performance and reliability.

% of total unscheduled downtime related to rolls

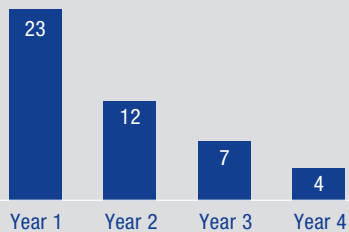

*Case study 1 result:
Greater than 50% reduction in downtime due to roll problems*

Paper machine efficiency [%]

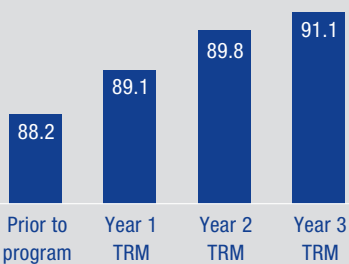

*Case study 2 result:
– Reduction in annual roll spending
– 3% increase in machine efficiency*

Voith Total Roll Management is a comprehensive program that takes care of all the needs of the rolls. It is based on deep cooperation and long-term goals. With this partnership, you get measurable results and bring significant contribution to your bottom line profit, today and into the future.

Voith personnel have tremendous know-how around the complete roll systems, and they are dedicated to everything related to rolls.

Voith Paper Rolls was the first to introduce the Total Roll Management concept. You can rest assured we are the most experienced partner in the industry, and our case study results speak for themselves.

What makes Voith Paper Rolls the Best Partner for You?

Within the TRM partnership, Voith Paper Rolls will be your single point of contact, working closely together with mill's specialists to achieve elimination of roll problems. Voith will stay – next to the internal specialist of the Rolls company – closely connected with other Voith Paper experts, which

are engaged in the whole papermaking process: fiber systems, graphic paper machines, board & packaging machines, fabrics, finishing and automation. The combined know-how of all these groups results in a truly comprehensive expertise throughout the entire papermaking process.

TRM Portfolio

Roll Systems

Voith Paper Rolls manufactures all types of rolls using the highest quality material combined with accurate and precise manufacturing procedures. Each roll is custom engineered with the latest design concepts, which means they are optimized for each application.

Roll Covers

Voith has a complete portfolio of roll covers and coatings. Starting from the wire section to the winder, Voith has roll covers specially designed for each position. Voith covers are top-rated in the industry, and the quality is well proven through many years of reliable service. Voith will recommend and fine tune the best cover for each roll position.

Roll Service

Voith services all types of rolls, regardless of original manufacturer. Periodically, rolls have to be completely reconditioned to the original specification. If needed, Voith can also perform engineering upgrades. Every solution is tailor made for the specific need, striving for maximum results for the cost.

Field Service

Voith Paper Rolls can also provide Field Service from the wet end section to the winder. For example, dryer cylinders can be balanced in your paper machine in their own bearings; this leads to highest balancing results and helps you reduce shut down time. Our Rollchange Teams are well known for shortest reaction times and very quick rollchanges. That helps you to keep downtimes to a minimum.

Voith also coordinates transportation of the rolls. Our roll tracking system, called SØNAR, is a unique software program that makes roll tracking very simple. It supports the entire TRM concept.

Implementation Steps

After the machine survey or reviews of rolls histories, e.g. past problems, difficulties, roll change intervals or roll grinding frequencies, are completed, various technical support tools are available to further optimize the paper machine operation.

The next step, after analyzing the data, is to present the findings and recommendations to the mill. The final step involves collaboration between the mill and Voith Paper Rolls in formulating the implementation plan.

Summary

Total Roll Management enables mill personnel to focus more time on the core business of papermaking, while getting the industry's best expertise on maintaining and optimizing rolls. With the TRM concept, the total responsibility for rolls is turned over to Voith Paper Rolls.

Voith has roll service centers around the world. We are there for you 24 hours a day, 365 days a year.

We will take care of everything related to your rolls to ensure, that roll issues will disappear and you can rely on your rolls everyday.

Implementation Steps



Contact



Jin Kim
Rolls
jin.kim@voith.com



Jochen Honold
Rolls
jochen.honold@voith.com

Product finder – The Voith Paper offering, now online

“Products & Applications” gives an overview of our entire offering. Find out what our products and services can do for you, check out our references, and get to know our customized “Perfect Fit” rebuild concept. You can also explore the future with us – take a tour of our Paper Technology Center and discover how your dream of tomorrow’s paper can already exist today.

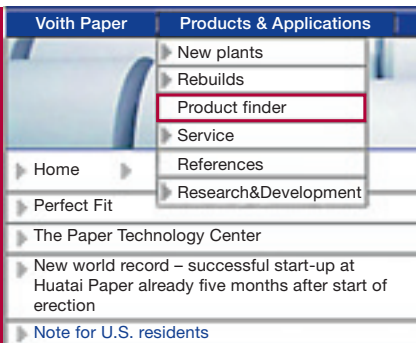

Product finder

Want to know what LWC paper is or how MD control works? Need information on CeraLease or optimal felting for your press section? No problem. Just call up the new online listing of Voith Paper products at www.voithpaper.com/products. It tells you immediately everything you want to know about our products as well as paper grades, papermaking technologies, and components such as rolls or automation systems.

Using the three panels Paper grades, Processes and Components **1**, you can narrow down your search as

much as you like. You’ll see a detailed listing of all Voith products, or you can get the same results with our full-text search engine **2**.

The example on the right shows Product finder results for Voith roll covers in the press section of LWC paper machines **3**. Just run the mouse over a product name to see a short “Tooltip” description **4**.

Click on the respective product to get detailed information on all its applications and benefits.

Voith Paper Products & Applications Current e-Business Jobs & Careers **VOITH** Voith Paper

Home Voith Group Deutsch

Product finder Products A-Z **Voith Drive** Back to search



Voith Drive is the integrated solution for an innovative drive which replaces the traditional arrangement of cardan shaft, gear unit, coupling and motor. The motors are simply mounted on the front or drive side, and they drive the rolls clearance-free and without any intermediate mechanical drive components. In this way, the gear casing and all mechanical drive components become superfluous.

Your Problem:

- Oil leakages of the gear train in the dryer section.
- High costs for maintenance of the gear train in the dryer section.
- Energy costs that are too high.
- Complex and cost-intensive spare parts purchasing for existing motors and gear units.

Our Solution:

The Voith Drive direct drive convinces by reliable operation because no additional components such as gear units and cardan shafts are required. Compact installation because the Voith Drive is mounted directly on the roll or cylinder journal and therefore, extensive adapting of the surroundings is no longer required.

Your Benefit:

- Lowering of energy consumption of about 5%.
- Reduced maintenance as gear train, gear units and cardan shafts are not required.
- Reduction of noise emission.
- Limited spare parts keeping.
- Improved environmental balance as no central oil lubrication system is required.

Contact
Diethelm Beisiegel
Phone: +49 7321 37 2966
Diethelm.Beisiegel@Voith.com

ProEfficiency
ProQuality
ProSpeed
ProEnvironment

Optimization targets

Literature

- Perfect Fit
- Product sheet

Detailed information

To give you some idea of what to expect in the future, this page shows the innovative Voith Drive system:

As a first impression we have put together some general product information and pictures. And the small graphic shows you our optimization goals in developing this product for you. If you want to know more, you can download our brochures to get detailed data on each product, its applications, special features, and benefits.

And, it goes without saying that we have open ears for all your questions: each product page shows the respective contact partner.

Product finder Products A-Z

Product finder

Reset all

1

Paper grades	Processes	Components
<ul style="list-style-type: none"> Graphical papers Board & Packaging Specialty papers Tissue papers 	<ul style="list-style-type: none"> Process automation Stock preparation Wet End Process Paper machine Finishing Environmental Solutions 	<ul style="list-style-type: none"> Machine clothing Optimization Rolls Roll covers Automation Tail threading
<ul style="list-style-type: none"> Newsprint SC paper LWC paper CWF paper UWF paper 	<ul style="list-style-type: none"> Headbox Wire section Press section Drying Coating & sizing 	

2

Search for Start

3

LWC paper – Press section – Roll covers Search result: 21 products

▶ Aqualis	▶ BlackStone S	▶ CeraForm
▶ CeraVac	▶ CeraVent	▶ DrillPress
▶ DrillPress HD	▶ G2000	▶ MagnaPress II
▶ MagnaPress II R	▶ MagnaRock I	▶ MagnaRock II
▶ MagnaRock II R	▶ PolyDyne	▶ SolarFlow
▶ SolarPress	▶ StratoPress	▶ StratoPress S
▶ TerraSpeed	▶ TopPress	▶ TopRock

4

Polyurethane cover for suction press rolls



*Customers in focus:
Münzing Chemie can now
concentrate its core activities
on business processes with
direct customer relations.*

Voith Industrial Services, fully integrated – The Münzing Chemie success story in Heilbronn

It couldn't be simpler – and it couldn't be better! In future Münzing Chemie can focus exclusively on its core activities: product development, purchasing, production and marketing. Voith Industrial Services takes over all other peripheral or internal services such as production logistics, maintenance and facility management. All input of the Voith companies involved is grouped together under "Integrated Services".

This is a pilot project both for Münzing and Voith, because such outsourcing has never been implemented to such an extent before in the chemical industry. The VIZ integrated services include preventive maintenance, upkeep and repair of all production facilities, other auxiliaries, and the entire piping network – including 150 pumps of various types. Also all the production media supply systems such as power, gas, water, and steam including the respective plant. Voith people fill each product batch completed at the Münzing plant into the right drums, and prepare all the necessary documents for our external

logistics partner. "We make sure that all the media and raw materials required are ready at the right time at the right place, in the right quality and in the right amount", says Frank Hüther, head of the VISI Chemical & Refinery business unit. Within the complex framework of Facility Management services, Voith also takes over additional tasks such as security and fire protection, cleaning, postal, and telephone services.

This integrated service package is rounded off by the process and applications experts of Hörmann Engineering – a Voith Industrial Services

company. Maintenance task planning, supervision and documentation are facilitated by "maint-CATS" software (Maintenance Control and Tracking System), thanks to which Hörmann Engineering solved the complex Münzing challenge in only four weeks. VIHC compiled among others import routines for the numerous databases and files, and was able to take over most of the relevant data semi-automatically. The customer placed special emphasis on the service and repair workflow and on transparent reporting between Voith and Münzing: "Our service and repair procedures were already in order previously, but with the comprehensive integration of additional functions and systematic digital linking, we can exploit substantial cost-saving and quality potential in future", summarizes managing director Michael Münzing. "If I ever had to make such a decision again, I would certainly choose the same solution and the same partner".



Hydro Power Plant Borçka at Çoruh river in the north of Turkey



At the push of a button: Turkish Prime Minister Recep Tayyip Erdoğan starts operation of hydro power plant Borçka



Borçka hydro power plant inaugurated by Turkish prime minister Erdoğan

Turkish Prime Minister Recep Tayyip Erdoğan inaugurated the Borçka hydro power plant in the northern part of the country.

The 300 MW power plant on the Çoruh river has been built by national utility DSI State Hydraulic Works. The plant is equipped with two Francis turbines from Voith Siemens Hydro, producing 1,039 GWh worth of energy per year. The order value was around 26 million Euro.

According to the Prime Minister in his inauguration statement, hydro power is Turkey's most important energy resource. "Today, its share is 36 percent of the Turkish energy mix. If the necessary measures are not taken immediately, energy shortage could be a trouble for all of us. Therefore, we are taking precautions rapidly", he emphasized. He affirmed to further support hydro power generation.

Borçka has been realized under a bilateral agreement between Austria and Turkey. It will be the penultimate power plant in the Çoruh basin, north-east of the Black Sea, built by DSI. The consortium consisted of Andritz VA Tech Hydro, Verbundplan (PÖYRY), Strabag, Voith Siemens Hydro Austria and local Turkish partners.

Voith Siemens Hydro Power Generation is a Group Division of Voith and – with a workforce of around 2,500 employees and an order intake of around € 720 million in the past business year – Voith Siemens Hydro Power Generation belongs to the world-wide leading companies for hydro power equipment.

Voith Turbo launches commercial WinDrive production

Higher grid stability with lower investment costs

The Voith WinDrive concept for wind-powered generators has reached commercial maturity. Using a Voith variable-speed hydrodynamic drive, this new technology eliminates the need for frequency converters in wind power plants. EU Energy Ltd./DeWind (GB/D) is the first customer to benefit from WinDrive. The first wind turbine with WinDrive started up punctually at the beginning of 2007 on the Cuxhaven, Germany, test site. Commercial production has now started mainly for wind park applications in North America.

WinDrive technology enables conversion of a variable input speed into a constant output speed. The wind turbine rotor can, therefore, rotate at optimal speed depending on wind velocity, squall-induced peaks are efficiently smoothed out, and wind force related shutdowns are no longer necessary. By allowing the use of synchronous generators, WinDrive will have a significant grid-stabilizing effect with high-powered wind generators in future.



Voith celebrates its 140th anniversary – 1867-2007

Voith, still a family-owned company, is 140 years old this year but as young and dynamic as ever. Founded in 1867 with 30 employees, Voith now employs 34,000 people worldwide, and holds 10,000 active patents to which 400 new ones are added each year. Order intake exceeds four billion Euros, and Voith continues to expand as a successful global player.

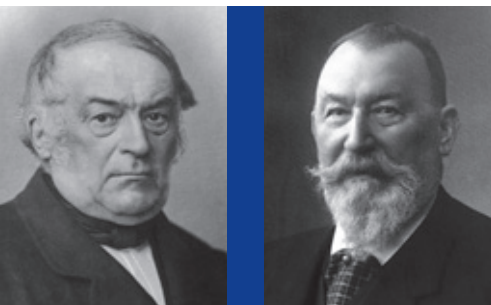

Johann Matthäus and Friedrich Voith

Top: The Heidenheim works in 1880

The official birth date of this future world star was August 6, 1867. On that day Johann Matthäus Voith handed over the original business to his son Friedrich, according to their agreement drawn up at the beginning of the year. Against payment of a “life annuity of fifteen thousand seven hundred and sixty one gulden” for his father, Friedrich Voith acquired a “locksmith’s workshop, including all machines, tools and inventories, located on the southern outskirts of Heidenheim between the river Brenz

and the new railway line to Ulm, in the kingdom of Württemberg”.

After graduating in mechanics and machine-building at Stuttgart polytechnic, Friedrich Voith spent several years with the renowned Swiss engineering works Escher-Wyss Zurich designing waterwheels, water turbines and paper machines. He had ambitious goals, and was confident of reaching them based on the foundations his father had laid. This is reflected in the name he gave his



company: J.M. Voith Engineering Works.

Those were times of headlong growth. The industrial revolution was in full swing, bringing radical changes throughout Europe as new technologies increasingly took over from traditional handicrafts. Turbines replaced waterwheels, and to satisfy the insatiable hunger of the fast new printing presses, paper was no longer made from rags alone but increasingly from groundwood pulp.

In 1869 Voith registered its first patent for a wood grinder with toothed loading rack. Known as the “Raffineur” (refiner), this machine

wrote technological history. It enabled for the first time high-quality groundwood production in large enough quantities for industrial papermaking.

In 1870 Voith began turbine production, and in 1873 built its first Francis turbine. This embodied a revolutionary improvement to the original American invention, by applying movable wicket gates to decisively extend the application range. In 1881 Voith delivered its first complete paper machine, with a wire width of 2.35 m.

When J.M. Voith celebrated its silver jubilee in 1892, the Heidenheim works employed 330 people. Ten years later this had risen to more than 1,000,

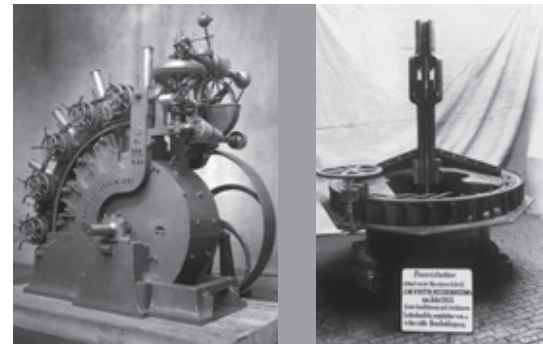

In 1869 Voith registered its first patent for a wood grinder. This one dates back to 1891. On the right is Voith's first Francis-Turbine, built in 1873.

Top: Voith apprentices in 1913

Layout drawing of Voith's first paper machine in 1881 for the Raitelhuber mill in Gemmrigheim, Germany

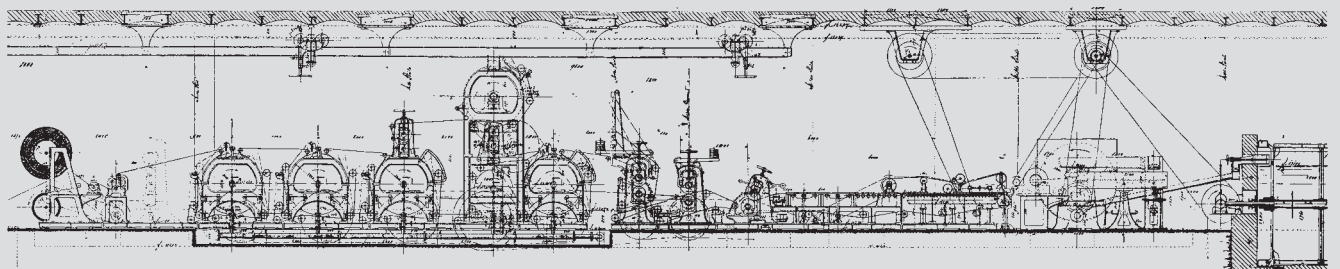



DIWA drive package for city transit buses



Voith Retarder power brake for commercial vehicles

making Voith the second largest machine-building company after Esslingen locomotive works.

In 1903 Voith received an order for the world's largest water turbines at that time, twelve 12,000 HP Francis turbines for Niagara Falls power plant in the USA. International business expansion led in the same year to the founding of Voith St. Pölten in Lower Austria, the company's first plant abroad. This provided a platform for market expansion into Eastern Europe and even Southwest Asia,

thus avoiding the otherwise restrictive customs barriers applying at that time.

Outbreak of the First World War in 1914 abruptly ended this international expansion for the time being. But Friedrich Voith, who had transformed the original locksmith business into a globally reputed company, was spared that trauma. He died in 1913 aged 73 years, and was succeeded by his sons Walther, Hermann and Hanns Voith. Following the collapse of the German empire, difficult times

ensued for Voith after the war ended in 1918. Sales stagnated in plant engineering, paper machinery and water turbines alike. It was paramount for the company to regain confidence among customers abroad.

In order to open up additional market areas where best use could be made of the company's pre-eminent turbo-machinery know-how and experience, Voith embarked upon the development and production of hydrodynamic couplings, transmissions and related components for vehicles and stationary machinery. With great commitment and perseverance, Voith then built up its third pillar business, the power transmission systems, in addition to papermaking technology and hydropower machinery.

In 1926 development work started on the Voith Schneider propeller based on designs by Viennese engineer Ernst Schneider. This marine propulsion and steering system for ferries, tugs and similar special-purpose vessels enables incredible manoeuvrability in all directions.

Voith Water Tractor with Voith Schneider® propellers

Voith Francis turbines for Itaipu, the world's biggest power station in Brazil

The WinDrive opens up new markets



In 1934 the first Voith Turbo transmission was installed in a diesel-hydraulic rail bus. This opened up a very lucrative business field: hydrodynamic transmissions and braking systems for diesel powered track vehicles. Thanks to the ongoing success of this Voith speciality, the first Voith mainline freight locomotive was delivered in 2006 after only 500 days including development, design and production.

From 1939 to 1945 the Second World War once again curtailed international business relations and activities. But Hanns Voith, who after the deaths of his elder brothers Walther and Hermann steadfastly held to their chosen course as of 1947, soon restored contacts with long-standing Voith customers both in Europe and overseas.

In 1950 Voith Power Transmission Systems started producing automatic differential torque converter transmissions (Diwabus) for city transit buses. This was followed in 1968 by the Voith Retarder, a hydrodynamic and,

therefore, non-wearing brake for trucks and other large commercial vehicles that is now a matter-of-course contribution to road safety.

On the occasion of the company centenary in 1967 Voith was able to draw a very impressive balance. Since its founding, Voith had sold 17,000 water turbines, 850 paper and board machines, 22,000 gear drives, 1,550 Voith Schneider propellers, 16,500 turbo-drives, 400,000 turbo couplings, and 25,000 DIWA automatic transmissions.

These imposing figures include numerous world records. The fastest and widest newsprint machines, for example, and the most powerful turbines for the world's largest hydro-power plants. But Voith has no need to boast and does not rest on its laurels: each new record is regarded as a challenge to break it again as soon as possible. What counts above all for Voith is customer benefit and satisfaction. This review of some epoch-making technological milestones over the last 140 years can, therefore, be

taken as only an indication of what is to come.

Sophisticated technology for increasingly complex systems and applications demands professional service and maintenance. Voith, therefore, embarked upon the 21st century with a fourth pillar business: Voith Industrial Services. This new division complements our production-oriented activities and is recording strong business growth. At the same time, however, our flow of innovations for Voith's traditional markets of paper-making and board production, hydro-power, and safer and faster mobility, is by no means exhausted. On the contrary, as noted by Voith AG Board Chairman Hermut Kormann:

“Our latest projects in tidal power technology, the WinDrive wind turbine drive system, the Voith Maxima locomotive, and the Voith Paper Technology Center not only highlight our engineering capabilities but also set benchmarks in profitable new technologies to drive the future growth of our company”.

Voith – Engineered reliability.

Maxima, the world's most powerful single-engine dieselhydraulic locomotive

The new Voith Paper Technology Center in Heidenheim

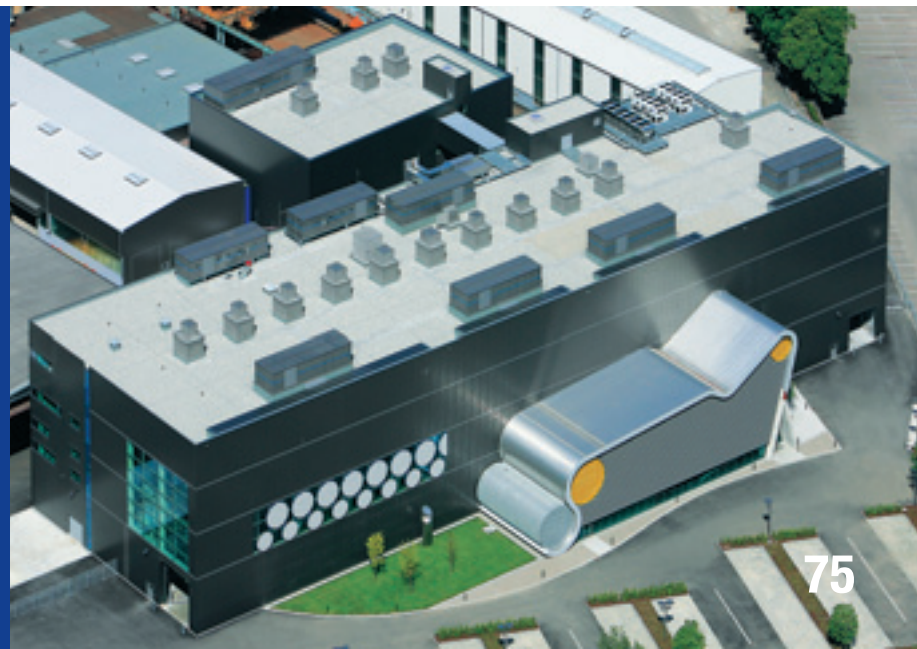

Voith Paper

Newsmagazine for the
international clientele,
partners and friends of
Voith Paper

“twogether” is published twice annually
in German, English, Chinese, Russian and
Finnish. Contributions by independent
authors do not necessarily reflect the
opinion of the publisher. Please address
all correspondence and inquiries to the
editor.

Published by:

Voith Paper Holding GmbH & Co. KG

Editor:

Dr. Wolfgang Möhle, Corporate Marketing
Voith Paper Holding GmbH & Co. KG
Tel. (+49) 07 51 83 37 00
Fax (+49) 07 51 83 30 00
Escher-Wyss-Straße 25
88212 Ravensburg, Germany
wolfgang.moehle@voith.com
<http://www.voithpaper.com>

Design, layout and typesetting:
Manfred Schindler Werbeagentur
P.O. Box 1243, D-73402 Aalen
www.msw.de

Issue 24, July 2007

VOITH
Engineered reliability.

*Copyright 7/2007: No part of this
publication may be reproduced or copied
by any means whatsoever without the
express permission of the editor.*