

# Two together

Paper Technology Journal



Gold East Paper, Dagang –  
A non-plus-ultra papermaking line.

**News from the Divisions:**  
Stonebridge – the world's biggest  
single-line deinking system in China.

Voith keeps customers "Perfect Fit"  
for the future – with custom-tailored  
rebuilt.

A vision becomes reality –  
Online calendaring of LWC offset/  
rotogravure printing grades with high  
DIP content at LEIPA, Schwedt.

Voith Paper Rolls Division –  
Your fast, flexible and reliable partner  
around the roll.

**Paper Culture:**  
"Black on White" –  
400 Years of Newspapers.

# 21

# Contents

## EDITORIAL

Foreword	1
Gold East Paper, Dagang – A non-plus-ultra papermaking line	2

## NEWS FROM THE DIVISIONS

“Stonebridge” – the world’s biggest single-line deinking system in China	10
Energy efficient HM Rotor – Power saving solution for virgin bale repulping applications	14
Voith Paper – A perfect partner at any time International Customer Symposium “Graphic Grades”: May 9 to 11, 2006	17
A vision becomes reality – Online calendering of LWC offset/rotogravure printing grades with high DIP content at LEIPA, Schwedt	18
Voith keeps customers “Perfect Fit” for the future – with custom-tailored rebuilds	22
Norske Skog Golbey – Upgrading the heart of the paper machine	25
Single NipcoFlex press technology – The cost-effective dryness guarantee for woodfree grades	28
Voith Drive – Small is beautiful; the innovative drive solution for a more economical paper production	32
RollMaster – new possibilities for optimizing and troubleshooting reeling systems	34
Voith Paper Rolls Division – Your fast, flexible and reliable partner around the roll	38
Voith Paper Rolls Launches the Latest Generation of Polyurethane Covers	40
PikoTeknik developed next generation non-stick roll coating	43
Endura series – Hard coatings for Yankee and MG Cylinders	44
Virtual Reference Grinding – Joseph von Fraunhofer Award 2005	46
Full steam ahead! Steam technology – an important part of the drying process	47
Paper Barring – Successful Optimization Through Systematic Analyses of all Relevant Subsystems	50
Computer Based Training (CBT) – interactive computer based training for the pulp and paper industry	54
High-shaft Technology – a weaving innovation breaks new ground in forming fabric design	58
Voith Paper and IHI Strengthen the Partnership – Create, Build-Up, Secure!	62
Right on the customer’s doorstep – Voith Paper Technology Days	64
Give work safety an additional chance	66

## PAPER CULTURE

“Black on White” – 400 Years of Newspapers	67
Highlights	70

*Cover illustration:  
New every day, but 400 years old  
the newspaper.  
In the background: Dagang PM 3*



Dr Hans-Peter Sollinger  
Executive Chairman Voith Paper

*Dear Customer, Dear Reader,*

*Once again, Voith Paper looks back on a very successful year. Nearly all our new installations and rebuilds were started up in time and rapidly attained target production after a short optimization phase.*

*Together with the high volume of orders received, this was reflected very favorably in our results for the year under review. Voith Paper again exceeded the good result of the previous year with a 2005 operating income at a record level.*

*Over the last few years we have purposely shaped Voith Paper into a comprehensive system supplier. The latest step in this direction was the merger of Voith Paper and Voith Fabrics into a single Group Division one year ago. Today our customers benefit all the more from complete solutions with "Perfect Fit" modules and elements.*

*As a complete system supplier, however, we want to be perceived as the "Perfect Partner" for our customers not only during the planning and execution phases, but right through the entire production line life span. Our primary goal in this connection is to minimize project costs, taking into account the specific investment costs including start-up expenses and ongoing operating costs and at the same time steepest possible start-up curves and optimal overall performance.*

*In order to stay one step ahead of our customers' demanding requirements, we always have technical innovations and new concepts in the pipeline. At the international Voith Paper customer symposium on May 9 and 10 this year, we shall be presenting our latest developments in detail.*

*As a special highlight of this symposium – entitled "A Perfect Partner at any time" – you can witness the inauguration of our new Paper Technology Center. By setting new benchmarks in enhanced solutions for the paper industry, this PTC will uphold our mutual teamwork by making you more competitive on the one hand, and on the other hand consolidating Voith's technological leadership even further.*

A handwritten signature in blue ink that reads "H. P. Sollinger". The signature is fluid and cursive, with a long horizontal stroke at the end.

Dr Hans-Peter Sollinger  
on behalf of the Voith Paper Team



**Thomas Frühauf**

*Paper Machines Graphic*  
thomas.fruehauf@voith.com



**Klaus Meier**

*Paper Machines Graphic*  
klaus.meier@voith.com



**Jörg Albrecht**

*Finishing*  
joerg.albrecht@voith.com

## **Gold East Paper, Dagang – A non-plus-ultra papermaking line**

**In 1999 Gold East Paper in Dagang, China started up their PM 1 and PM 2 coated wood free grades lines supplied by Voith. Since then both paper machines, with a wire width of 10,400 mm, have continually increased speed and production records. Dagang is a green-field mill three hours' drive from Shanghai on the Yangtze, China's biggest river. The site was foresightedly dimensioned to allow enough space for additional paper production lines. In August 2003 the Zhenjiang Star Group in Yiangzu province decided to add another production line in Dagang, and Voith, as preferred supplier, received the order for PM 3, likewise operated by Gold East Paper.**

<b>Max. parent roll diameter</b>	<b>3,500 mm</b>
<b>Parent roll width</b>	<b>9,770 mm</b>
<b>Max. parent roll weight</b>	<b>130 t</b>
<b>Production capacity PM 3</b>	<b>1,100,000 t/year</b>
<b>Wire width PM 3</b>	<b>10,600 mm</b>



This makes Dagang, in Yiangzu province, China's biggest production plant for double-coated wood free grades. Gold East Paper now operates three production lines there with a total capacity exceeding two million tons annually.

The PM 1 and PM 2 machines delivered by Voith in 1999 each produce 500,000 t.p.a. of art paper, roll offset and copy paper (see *together 8*). The new Voith machine PM 3 that started up in mid-2005 is designed for producing similar or higher-quality grades at the impressive (100%-efficiency) rate of 1,100,000 t.p.a.

In view of China's steeply rising paper consumption (at about 8% p.a.), Zhenjiang Star Group expanded production capacities in Dagang to meet demand accordingly. This also reflects China's efforts to increasingly cover paper requirements from its own mills, at the same time catching up with the latest technology or even advancing to the front line.

Here is what Gold East Paper says: *"China's paper market is enormous, so capacity expansions are indispensable. Dagang is the ideal location for this expansion project. There is still enough space there, and all the necessary infra-*

*structures and logistics are in place. The Yangtze river provides plenty of process water, and there is no problem with additional energy supplies. Our new PM 3 gives us so much more production capacity that we can now meet the rising demand for coated wood free grades both in Asia and internationally."*

Raw materials supplies are assured by river transport on the Yangtze, with direct connection to the ocean. Fiber material, coating materials, chemicals and additives are either transshipped at the Gold East Paper dock in Dagang, or supplied from the company's own warehouses.

## The project – innovation plus investment security

Voith was entrusted by the Chinese client in August 2003 with full responsibility for this bold and innovative project. From pulp bale handling to finished paper rolls, Voith supplied all key components of the new PM 3 production line.

Another Gold East Paper comment:

*“Our new PM 3 meets a long-standing need. Voith is a highly competent and reputed supplier of papermaking lines and auxiliary equipment, and our cordial partnership with Voith in all areas of paper-making technology goes back many years. It has always been matter-of-course for us to develop new concepts and innovations together. That is one of the main reasons why Zhenjiang Star Group and we as plant operators chose Voith to supply this new production line.”*

At the heart of this new facility is the on-line paper machine for double-coated wood free grades in the basis weight range of 70-128 g/m<sup>2</sup>, based on the Voith “One Platform Concept”. Gold East Paper’s new PM 3 incorporates innovative trend-setting key components well-proven over the years on dozens of production lines worldwide. And the latest technologies are used here in order to meet the demanding requirements for dependable production and high profitability.

The project was executed according to Voith’s “Process Line Package” procedure. In other words, Voith as coordinating partner was responsible for the design, procurement and installation supervision of everything affecting the papermaking process. Voith was also responsible for meeting all deadlines and complying with the quality and production specifications – to the great relief of all concerned!

With a wire width of 10,600 mm PM 3 may not be the widest paper machine in the world, but experts have known for a long time that production output depends much more on throughput and overall line efficiency than on wire width. Its enormous capacity of 1,100,000 t.p.a. (at 100% efficiency) and design speed of 2,000 m/min make PM 3 the world’s high-performance paper machine.

Compared with the PM 1 and PM 2 lines, this new one represents a quantum leap in production capacity and speed. Another development challenge was the online operation of PM 3 with integrated coating machinery (1 SpeedSizer and 2 JetFlow F coaters), as against PM 1 and PM 2 that still produce coated grades in an offline concept.

### Stock preparation

Two complete fiber lines for bleached short fiber chemical pulp, each including short bale handling and pulper charging system

plus the well-proven TwinFlo double disc refiner technology – together with a complete line for bleached long fiber chemical pulp – ensure the necessary high finished stock quality is fed to the blending chest. Well-proven stock preparation process components are installed, including Voith VS pulpers and E series deflakers.

Peripheral cleaning, screening and processing stages prepare the stock to the required quality before it is diluted and pumped to the MasterJet headbox. The approach flow includes the two largest pressure screens ever supplied by Voith, each with a total screening area of 13 m<sup>2</sup>.

### Paper machine

The DuoFormer TQv has a MasterJet headbox with well-proven OnQ ModuleJet dilution water control. The forming unit generates a homogeneous sheet by perfect fines and filler distribution to improve formation with almost symmetrical drainage.

After sheet formation in the DuoFormer TQv, the wet web is taken off the bottom wire by the first pick-up roll and fed to the Tandem NipcoFlex press section without open draws ensures optimal runnability. Here the web is further dewatered and compacted. The shoe length plays a particularly important role in this connection by preventing crushing of the hard-to-dewater furnish.

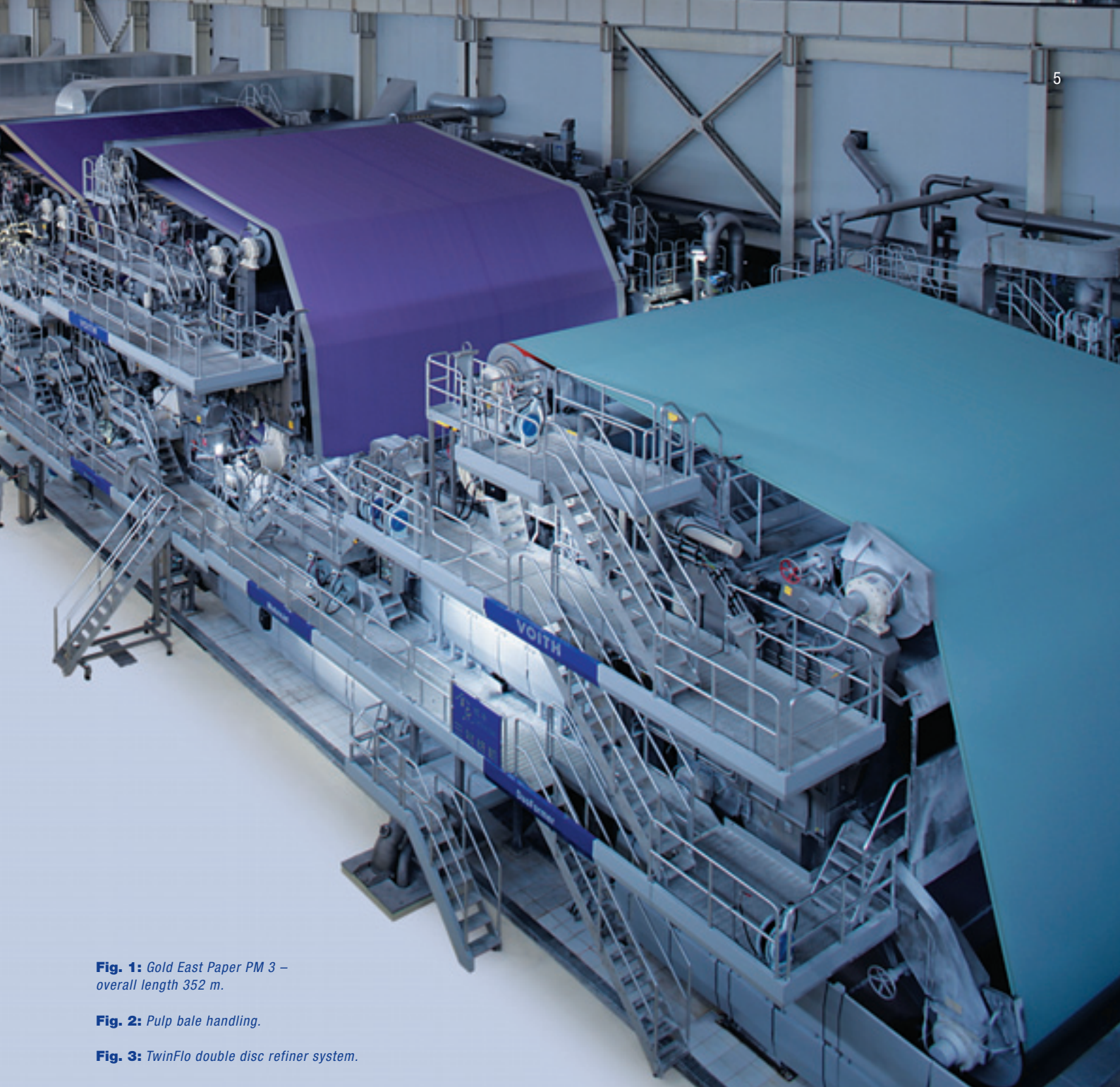

**Fig. 1:** Gold East Paper PM 3 – overall length 352 m.

**Fig. 2:** Pulp bale handling.

**Fig. 3:** TwinFlo double disc refiner system.



In the TopDuoRun dryer section, fitted with a ropeless sheet transfer system, the web is dried to a residual moisture content of 4%. Voith Paper Automation supplied an EnviroScan for the first dryer group that enables online measurement of dryness values and moisture cross-profile directly after the press section – precisely the tool papermakers have always dreamed of!

To ensure consistently uniform coating in the SpeedSizer, the web is pre-calendered

after the dryer section in an EcoCal calender with a FlexiTherm top roll (at 80 °C surface temperature) and a 52-zone Nip-Corect bottom roll. This guarantees an excellent CD profile, as required.

The SpeedSizer, optionally using sizing, coating or a single-sided combination of both and applies the precoat to the paper. The following infra-red and convective drying makes a targeted balance possible by influencing binder migration and penetration.

The web is then coated on-line in two Voith JetFlow F dynamic blade coaters. As a new development, the blade beams are entirely made of CFC (Carbon Fiber Compound), a world-wide first in this width. For the specialty grade calendar paper, conventional sizing is used on coater 1 instead of color, which is otherwise used only in film presses. The new dynamic coater has no problem with this.

The three TopDuoRun after-dryer sections following the SpeedSizer and blade coaters are of conventional design with open hoods.

For perfect coating results, optimal infra-red drying is required. After excellent results with the Krieger infra-red dryers already operating for years on paper machines 1 and 2, the customer again chose Krieger equipment. An integrated dryer was, therefore, installed after the SpeedSizer, and four more InfraAir drying systems after the two JetFlow coaters. They are all fitted with the Krieger InfraMatic

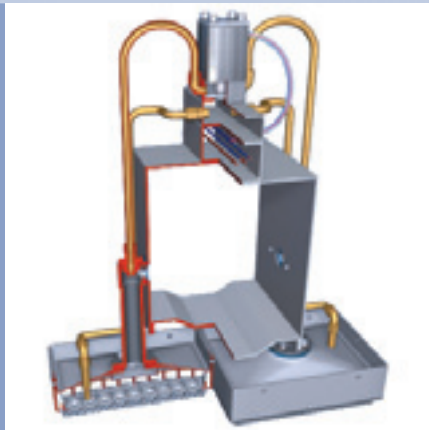





system for perfect control of moisture cross-profile. The infra-red dryers on PM 3 represent an installed infra-red capacity of more than 15 MW in a very small space.

At the end of the paper machine the double-coated sheet is wound up on a well-proven Sirius reel into jumbo rolls weighing 130 tons each. Reel spool changes are done by Voith's patented EcoChange W, an ingenious device with two traversing high-pressure water jets that slit the web at lightning speed before it is taken over by the new empty reel spool.

In order to minimize the risk of sheet breaks, above all during coating, this state-of-the-art paper machine is also fitted with a web inspection system.

Voith Paper Automation furthermore supplied cross-profile control systems along the machine, a complete bearing monitoring system, and the entire machine control engineering.

## Finishing

The finishing section includes a reel spool/parent roll handling system, two Janus MK 2 calenders, and two VariPlus winders.

The reel spool handling system includes 3 automatic parent reel carts and 3 magazines for parent rolls as well as 4 magazines for empty reels spools.

Included in the scope of supply are two very large 10-roll offline Janus MK 2 calenders. The 45° stack angle enables fast roll changing and easy access to all relevant component groups. Maximum operating speed is 1,500 m/min. Nipco rolls are used at top and bottom. The polymere

**Fig. 4:** Coating section – the two on-line DynaCoaters, each followed by a TopDuoRun dryer group.

**Fig. 5:** InfraAir.

**Fig. 6:** Sectional view of the InfraMatic.

**Fig. 7:** Janus MK 2.

rolls with Rubin G covers are flexible rolls and extremely resistant to marking and wear. Thanks to the patented NipProtect system, all rolls can be opened smoothly in considerably less than 0.5 seconds. Rapid parent roll changing is ensured by unwinding with flying splice. A Sensomat Plus ensures meticulously wound rolls. Apart from the normal 9-nip Janus operating mode, both machines can also run in single-nip mode; the paper is then calendered in the top and bottom nips. These Janus calenders give the paper surfaces optimal gloss and smoothness, resulting in excellent printability.

The two highly automated VariPlus winders cut the 10 m wide web into smaller





8

widths and wind them into rolls according to the size required by the consumer. For the grades produced in Dagang, the Vari-Plus is the ideal machine: the roll sets are supported on the center drum in the 3 o'clock and 9 o'clock positions respectively, thus enabling the particularly sensitive line force control required for delicate paper surfaces. This positive effect is reinforced by a patented MultiDrive cover on the center drum that greatly reduces the line force acting on the roll set. Even with 6-ton paper rolls wound at 2,500 m/min, the VariPlus winders still

run perfectly smoothly. The result is faultlessly wound paper rolls with optimal hardness. Since both winders are equipped with automated butt-splicing for unwinding, there are no ungainly splices in the finished rolls and further processing by the consumer is all the more trouble-free.

The impressive dimensions of this paper machine are underlined by the following technical data:

- Production capacity 1,100,000 t.p.a.
- Design speed 2,000 m/min
- Wire width 10,600 mm
- Overall length from former to winders 352 m
- Total number of components manufactured 1,585,900
- Number of containers delivered 1,300
- Number of individual deliveries 9,200
- Total weight of all deliveries 37,600 tonnes.

### Erection and commissioning – all targets reached on time

Projects of this magnitude cannot succeed without perfect teamwork between customer and supplier right from the start. Once again, Gold East Paper and Voith met this joint challenge very successfully. The results speak for themselves. After finalizing the machine concept together, the engineering work started. Since the start-up date had already been established, there was no time to waste, so Voith took over the basic and detailed engineering for the entire production line.

All expectations were fulfilled, and the all-important engineering documentation was handed over in good time.

As before with PM 1 and PM 2, the customer took over all erection work. Gold East Paper installed tens of thousands of machinery and plant components fault-

9



10

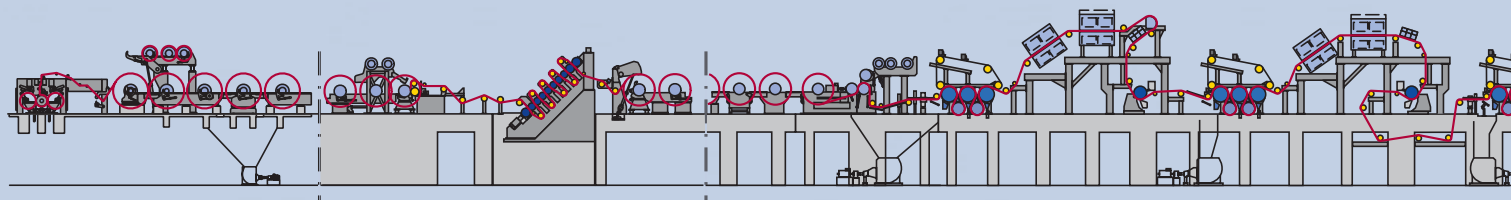



lessly under Voith supervision – a fantastic achievement.

Meanwhile the well-planned training program was started. For twelve weeks the customer's personnel learnt all the necessary theoretical knowledge, backed up with tours of the plant in course of erection. This was followed up by practical training directly on the machine, including the commissioning and start-up phase.

The operating checks also began on time, and only a few days after the first paper on wire, the Sirius reel was already winding up at full web width. As a result, the start-up deadline was beaten by a full week.

Furthermore, all fabrics were supplied by Voith Paper Fabrics and showed excellent results throughout the paper machine – well-coordinated single-source deliveries certainly pay off!

### The results – first class paper in record time

After more than meeting the start-up deadline, the next step was to optimize the product quality. Gold East Paper and Voith scored a bulls-eye in numerous respects with the PM 3 project. After fulfilling all the product quality guarantees only six weeks after startup, operation test acceptance already took place in mid-December 2005. The paper grades produced on this machine are destined not only for the Chinese market, but also for export.

The production speed increases were likewise reached earlier than planned. Currently the machine is producing first-class art paper at a steady speed of 1,500 m/min, and roll offset printing grade production is in the test phase.

Further quality optimization and efficiency enhancement measures are proceeding intensively, so that steady operation at 1,800 m/min should soon be reached.

All in all, Dagang PM 3 sets benchmarks not only in Voith Engineered Reliability, but also in Gold East Paper Innovation, Efficiency and Punctuality.

**Fig. 8:** The OnV web inspection system plays a vital role.

**Fig. 9:** VariPlus winder.

**Fig. 10:** Schematic layout of PM 3.

### Voith scope of delivery

Complete production line comprising stock preparation, paper machine and finishing section as described above, including in detail:

- 4 bale dewiring and raw materials handling systems for feeding 3 virgin fiber pulpers
- Advanced Wet End Process (approach flow, broke preparation and fiber recovery)
- Process water systems including water treatment and cooling water
- Chemicals preparation and dosing technology
- Broke pulpers and broke preparation
- All chests and tanks
- Vacuum systems
- Steam and condensate systems
- Air technology for the paper and coating machines
- Working stations for pre-coat and top-coat color
- Complete tail threading systems including belts and tail cutters
- Paper roll transport systems including parent reel carts and conveyors
- Central lubrication systems
- Compressed air plant
- All piping and valves
- PCS 7 control systems for the paper machine, Janus calenders and winders
- Web inspection system comprising 3 transmission and 2 reflection beams
- Voith Monitoring vibration analysis system for the complete production line
- All field instruments and control valves
- All PM clothing by Voith Paper Fabrics (VF forming wires, press felts and dryer fabrics)
- Re-reeler

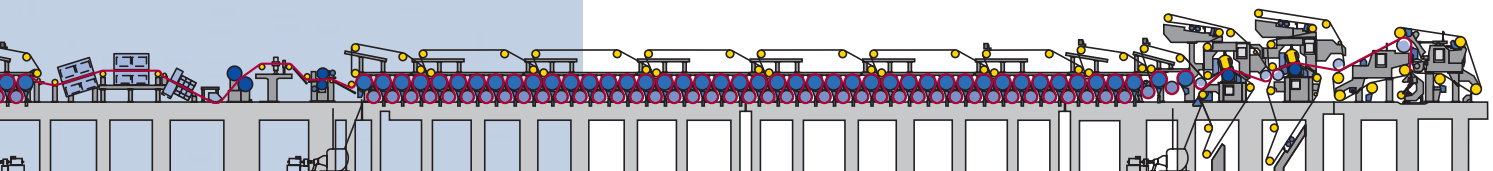



## **“Stonebridge” – the world’s biggest single-line deinking system in China**

**On May 23, 2005 the deinking system started up at Hebei Norske Skog Longteng Paper Co.’s new greenfield newsprint mill in Zhaoxian/Hebei Province, China (Fig. 1). Designed for 330,000 tons per year of newsprint from 100 % recovered paper, this mill now operates the world’s biggest single-line deinking system so far, with a capacity of 1,100 BDMT/24 h finished stock.**



**Kai Bestian**

*Fiber Systems*  
*kai.bestian@voith.com*

“Stonebridge” is not only the name of an ancient bridge in Hebei Province, it also serves as codeword for Voith Paper’s delivery of the world’s largest single-line DIP system so far. The quality decisive key components of this new deinking line

– from bale dewiring, pulper charging and stock cleaning right through to the storage tower, including water clarification and rejects handling – were delivered by Voith as a model example of its proven EcoProcess concept.



**Fig. 1:** Hebei Norske Skog Longteng Paper Co. in Zhaoxian, Hebei Province, China.

**Fig. 2:** Block diagram of up to now the world's biggest single-line deinking system DIP I at Hebei Norske Skog Longteng Paper Co.

**Fig. 3:** Part of the pulper charging line, bale opener on the left.

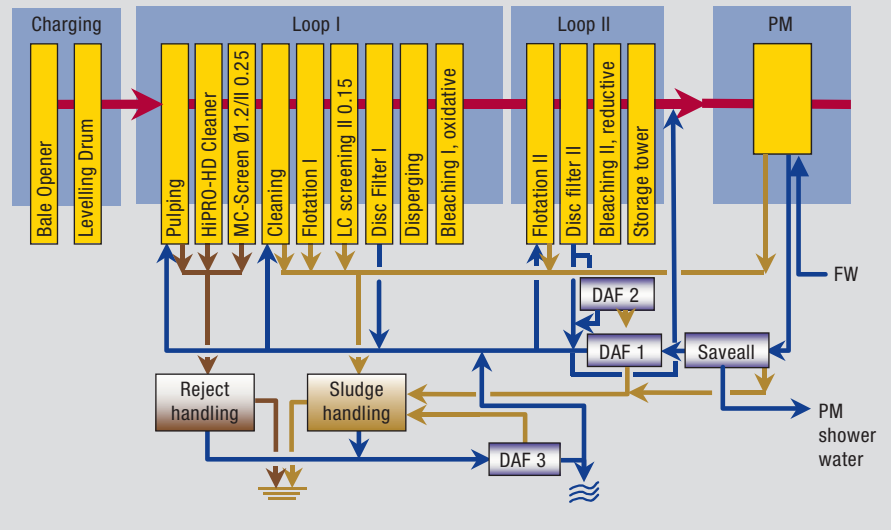

**Located in China's "golden triangle"**

It is not by chance that Zhaoxian was selected as the location for this high-tech newsprint mill. The Norske Skog Pan Asia Group took the clear decision to decisively participate in China's future economic growth in the "golden triangle" area, comprising the regions Peking, Tianjin and Hebei Province.

**Focus on customer benefit**

Norske Skog Pan Asia's decision to significantly expand its existing presence in the Chinese market (Shanghai Pan Asia Potential) with this major investment required meticulous planning and, as one of the most important factors, a strong partner. Voith's comprehensive deinking know-how

in particular, and excellent operating experience with numerous Voith deinking systems delivered to Norske Skog Pan Asia, predestined Voith as a strong partner with a successful track record. Based on good experience on both sides, great importance was attached by the customer and supplier to using technology and components well proven in practice.

**Scope of supply**

The stock preparation system is designed for a capacity of 1,100 t/24 h finished stock using 100 % recovered paper furnish in preparation to take advantage of the national collection of recovered paper in China.





**Kyoungyong  
Lim**

**Senior Operations Manager  
Hebei Norske  
Skog Longteng  
Paper Co.**

*“We are extremely satisfied with our paper quality so far. This success is largely attributable to Voith’s smooth and efficient project handling.”*



4

Voith not only supplied the key DIP process components influencing quality, – from bale dewiring and pulper charging, HC cleaning, MC, IC and LC screening, through to EcoCell flotation, disc filtering, dispersion, process water treatment and rejects handling – but also basic engineering for the process and automation technology.

The system is designed as a classical 2-loop system (Fig. 2).

The recovered paper is fed to Loop I via a bale opening and pulper charging system from Voith Paper Euskirchen, with a capacity of around 110 bales per hour (Fig. 3).

After pulping, the stock is passed via HC cleaning to a 2-stage Combisorter MC hole screening subsystem, followed by

2-stage IC slot screening. This pre-screening is critically important for highly effective stickies removal at an early stage in the stock preparation process.

After pre-screening and cleaning, the first stage in deinking, comprising EcoCell preflotation (Fig. 4), is installed. This is followed by a 4-stage LC slot screening for optimal stickies removal (Fig. 5). The A-B design in the second stage is not only highly efficient, it also minimizes size reduction of the stickies and ensures reliable operation. Here the proven MSS Multi-Screen and MST MiniSorter technology is in operation.

Accepts from the LC slot screening are then thickened using Thune disc filters before passing to dispersion (Fig. 7) and oxidative bleaching.

The second loop comprises EcoCell post-flotation for residual printing ink removal (Fig. 4), then further thickening using Thune disc filter technology, and finally reductive bleaching to ensure the required brightness increase.

Voith Paper Fiber Systems’ partners for this project were Voith Paper Euskirchen who delivered the complete recovered paper charging system, Voith Paper Tranby with their proven disc filters, and joint-venture partner Meri who supplied the subsystems for water treatment (Fig. 8) and rejects handling.

With this clearly defined stock preparation concept, the quality objective of effectively removing contaminants at an early stage at high production rates, has been reached very successfully.

**Fig. 4:** EcoCell pre- and postflotation.

**Fig. 5:** 4-stage LC slot screening with A-B design in the second stage. In the bottom right hand corner is the MiniSorter final stage hole screening, in the background the Thune disc filters and on the right the EcoCell flotation.

**Fig. 6:** Part of the covered storage for recovered paper.

**Fig. 7:** Disperger system with direct steam heating.

**Fig. 8:** Meri's Deltapurge microflotation in the final stages of assembly.



Apart from basic engineering for the process and automation technology, the stock preparation supply package also included supervision of erection and commissioning.

The basic engineering for the automation technology covered equipment layout, functional planning, software testing and commissioning support.

Technical data	
Plant	DIP 1
Product	Newsprint, 60% ISO
Furnish	65% American Old Newspapers 15% Chinese Old Newspapers 20% American Old Magazines
Design capacity (pulper charging)	1,350 t/24h bone dry
DIP finished stock (gross)	1,100 t/24h bone dry



## Energy efficient HM Rotor – Power saving solution for virgin bale repulping applications



**Jerry Aue**

Forest Products Energy Engineer  
Focus on Energy  
Aue Energy Consulting  
Plover, Wisconsin, USA  
jaue@charter.net



**Bill Fineran**

Voith Paper Inc., Appleton, USA  
bill.fineran@voith.com

A recently completed demonstration project, funded partly by the Wisconsin Focus on Energy program and Wisconsin Public Service Corporation, was conducted to measure the performance and energy savings of the Voith engineered HM Rotor installed in a virgin furnish repulper at Wausau Paper in Rhinelander, Wisconsin, USA.

Wausau Paper is a leading producer of fine printing and writing, technical speciality and towel and tissue papers. Their Rhinelander, Wisconsin location produces pressure sensitive and protective barrier papers on three paper machines.

### Introduction

A multitude of economic forces are presently at work influencing the profitability of paper mills. Rising energy costs contribute to these economic pressures. In addition, non-integrated mills that must purchase their raw paper making fibers are at the mercy of volatile market pulp prices.

Voith designs equipment and solutions to help mills offset their rising operating costs. Many paper mills purchase their raw materials in the form of dried pulp bales for use as their paper making fiber furnish. These mills must make down, or repulp the bales in order to put the pulp fibers into suspension for preparation and delivery to the paper machine. The repulper, used to mix the pulp bales in water is, in simple terms, a large tank with a mixer, or rotor, on the bottom. Energy is applied to the rotor in order to

provide agitation that causes the material on top to be drawn below the surface of the water and defibered. A mill typically operates several furnish repulpers, twenty four hours a day, seven days a week.

Repulper rotor blade design is one area of opportunity that Voith has identified to control a mill's operating costs. The energy saving HM Rotor (Fig. 1), a tall, swept-back blade design, has been engineered by Voith to provide effective turbulence of fiber suspensions with maximum rotor-fiber contact while consuming low energy. The HM Rotor is specifically intended for retrofitting existing repulper rotors in North America.

While considering the HM Rotor technology for one of their existing furnish repulpers, Wausau Paper turned to Focus on Energy to verify the energy savings by testing and metering the HM Rotor in comparison with a conventional rotor in the same repulper.

Focus on Energy is a public-private partnership offering energy programs whose goals are to encourage energy efficiency and use of renewable energy, enhance the environment and ensure the future supply

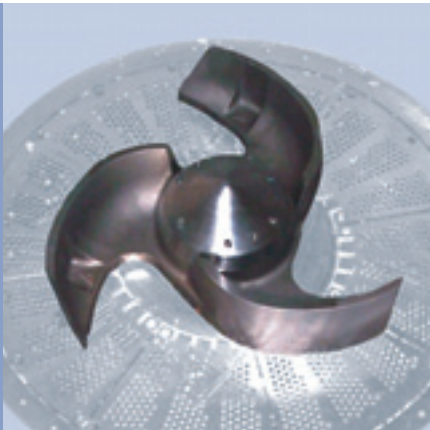



of energy. Their services include walk-through audits, project evaluation assistance, measurement and evaluation of savings, financial assistance for stalled projects, training opportunities, tools to manage energy and third-party reviews.

**Mill test conditions**

The Focus on Energy Program provided a share of the cost to verify savings projections. Wisconsin Public Service Corporation, the local electric supply utility, teamed with Focus on Energy by providing the electrical metering. Voith and Wausau Paper conducted the defibering examination, freeness, fiber quality analysis and other testing.

Wausau Paper uses 50 percent hardwood and 50 percent softwood in their process furnish mix. The mix consists of 100% virgin fiber purchased in the form of dried pulp bales.

The mill used the same furnish recipe throughout all testing performed during our demonstration and all efforts were made to operate the pulper under similar process conditions (operating level, temperature and pulping consistency).

The existing Voith repulper was initially installed at the Rhinelander mill in 1992. The repulper was supplied with a HOG Rotor which, for the purpose of our comparison, is referred to as a “conventional rotor”. A new HOG Rotor (not worn) was installed for this test. The repulper operates on a batch basis and is designed to deliver approximately 8,000 lbs of fiber per batch. Pulping time is 15 minutes.

**Test procedure**

Representatives from Wausau Paper, Voith, Wisconsin Public Service and Focus on Energy met to form a test plan. The goal of our testing was to verify that fibers are

**Fig. 1:** Energy saving HM Repulper Rotor.

**Fig. 2:** The results of six days of power monitoring – conventional versus HM Rotor.

**Fig. 3:** Consistent reduction in energy requirement throughout the pulping time compared with the conventional rotor.  
Furnish: 50/50 bleached hardwood/softwood pulp

separated properly (100% defibered within the existing pulping time), that the new blade had no adverse impact on fiber quality and to record the difference in power consumption between the two blades.

An assessment of the rotors included the conditions inside the pulper and measurements of the gaps to insure proper clearance between the rotor and extraction plate. Electrical use was metered for the test period. The metering recorded the rotor energy (kW) used in 15 minute intervals.

We also recorded motor load amperage readings throughout the pulping time. Pulper grab samples were taken at 4, 6, 10 and 15 minute intervals from startup.

We measured the degree of defibering on all grab samples using two methods. In the first method, a diluted sample was

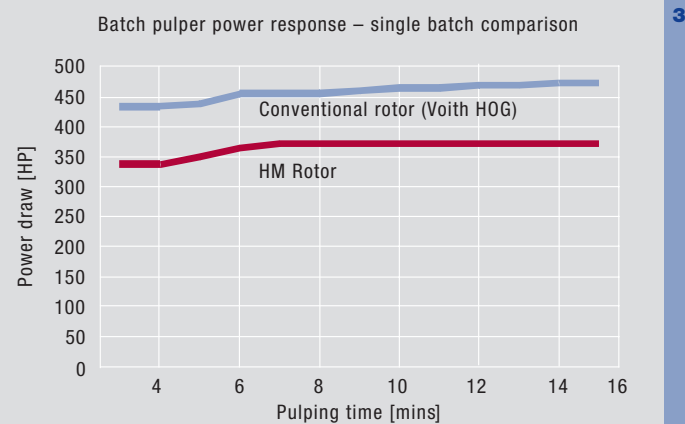
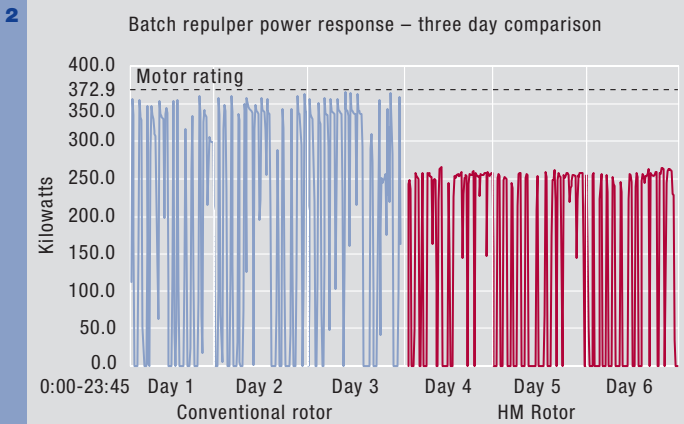

**Fig. 4:** Identical defibering characteristics between conventional and HM rotors.  
Furnish: 50/50 bleached hardwood/softwood pulp

**Fig. 5:** Energy saving HM Rotor summary.

poured onto a blue glass. Undefibered material on the glass was compared to a Voith Speck Index (VSI) to establish the degree of defibering.

In the second method, hand sheets were made from all grab samples. Undefibered material visible in the dried hand sheet was compared to the VSI to confirm the degree of defibering. Defibering indexes and consistency measurements were made at millsite for all tested pulper batches. In order to compare the impact of the rotors on the pulp fibers, freeness testing and length/fines distributions were performed on the 15 minute grab sample at the lab of Voith in Appleton, Wisconsin.

## Results

The gaps between the rotor blade and extraction plate were measured to be within tolerances set by Voith Paper for all test

conditions. **Fig. 2** shows the results of six days of metering power demand for the conventional rotor versus the HM Rotor. **Fig. 3** is generated from amperage draw measurements taken throughout individual pulper batches. Both **Figs. 2 and 3** show that average energy demand was consistently reduced by approximately 25% after installing the HM Rotor. Note that peak energy demand throughout the pulper batch was reduced by 28%.

**Fig. 4** shows that the HM Rotor provided identical defibering characteristics when compared to the conventional rotor. Comparison of the results of freeness tests and fiber length distributions showed no appreciable differences between conventional rotor and HM rotor batches.

## Conclusion

The HM rotor required 25% less energy than a conventional rotor to repulp identi-

cal furnishes under similar process situations. This reduction in energy represented cost savings for the mill of US \$ 28,000 per year (**Fig. 5**). The HM Rotor defibered the pulp furnish to the same degree as the conventional rotor without adversely affecting fiber quality. This project, partially funded by Wisconsin's Focus on Energy Program and Wisconsin Public Service verified that the HM Repulper Rotor saves paper mills energy and will significantly lower their operating costs.

## Acknowledgement

Focus on Energy, Wisconsin Public Service Corporation, Voith and the authors are grateful to Wausau Paper for their permission in presenting this article and to Tim Hasbargen, Manager of Engineering, Utilities and Environmental at Wausau Paper for his assistance with this project.

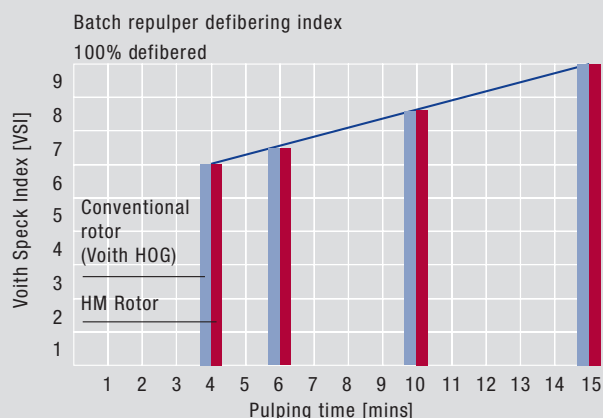

## Summary of energy savings – batch repulper

	Conventional rotor	HM Rotor
Peak consumption [kW]	368	265
Average consumption [kW]	336	259
Batch cycle – fill, pulp, dump		
Motor operation [h/day]	20.8	20.8
kWh/day	6,989	5,387
kWh/year [350 days]	2,446,150	1,885,450
kWh/year saved		560,700
<b>Cost savings [USD]</b>		<b>28,035</b>
Energy costs USD 0.05/kWh		



## **Voith Paper – A perfect partner at any time**

### **International Customer Conference**

### **on “Graphic Papers”: May 9 to 11, 2006 in Ulm**



**Anja Lehmann**

*Marketing  
Paper Machines Graphic  
anja.lehmann@voith.com*

**To meet graphic paper market demands today – ongoing quality rises but continuous price reductions – a thoroughly dependable partner is indispensable.**

At our customer conference from May 9 to 11, 2006 you will see what we mean by “Life Cycle Partnership” and why Voith Paper is the right partner to help you realize your company goals.

To keep you competitive in today's tough market conditions, we support you with customized solutions over your entire plant life cycle.

Various case studies of trend-setting reference projects covering all paper machine life-cycle phases will be presented at the Ulm congress center. In an outstanding evening program at this symposium

we will take you to a virtual and culinary trip past the milestones of paper-making history – from the beginnings in China right into the future.

As another highlight, you can witness the inauguration of our new Paper Technology Center (PTC) in Heidenheim on May 11. Here you will see the world's first paper production line on a research unit scale.

If you would like to attend this highly interesting symposium, we shall be pleased to send you full details if you fax us your name and address to our service hotline number: ++49 7321 37 7566.

## A vision becomes reality – Online calendering of LWC offset/rotogravure printing grades with high DIP content at LEIPA, Schwedt

**In recent years there has been a growing interest in online coating for LWC offset and ULWC grades, including online calendering.**



**Michael Ganasinski**

Finishing  
michael.ganasinski@voith.com

Online calendering of LWC offset printing papers is also favoured by indirect coating (film coating), which stresses the web much less than direct coating (blade coating). A drawback, however, of film coating is that although the paper is covered well and uniformly, the coating follows the surface contours and causes roughness. This effect is intensified by film splitting in the nip outlet.

Online Janus calendering results on average in PPS S10 roughness of ~1.3 to 1.8  $\mu\text{m}$  and Hunter gloss values of 50-60 %. Such values are well suited for off-set printing grades.

One of the first trend-setting installations in this connection was the small but excellent Voith PM 4 at Perlen Papier AG, justifiably known as the PM 4 Pioneer. This was followed up later on with rebuilds at Madison/Alsip and Bowater/Catawba.

Offline calendering is still widely preferred. On the one hand for LWC rotogravure grades, on the one hand because direct blade coating is only possible offline for good machine runnability. And on the other hand, the high surface quality demands for these grades are more easily fulfilled by offline calendering, using two to three low-speed calenders together with the offline coating machine.

### The vision

LWC calendering was debated in detail in the *together* special edition “Systems of Finishing” of October 2002. That article closed with the following words:

*“Particularly for LWC offset and ULWC production, there is a growing demand for online machine concepts and online calendering accordingly. Moreover with the*

*current trend toward lower basis weights and higher DIP content ... there is also a growing interest in online calendering concepts for rotogravure printing grades."*

Hence three wishes were still unfulfilled at that time:

- Firstly, a further increase of DIP content in online calendered LWC offset grades;
- Secondly, online calendering of LWC rotogravure grades;
- And thirdly, a high DIP content also in online-calendered LWC rotogravure grades.

Meanwhile all three of these wishes have been fulfilled, so it is worth taking a closer look at the latest developments in LWC online calendering. A good example is PM 4 at the LEIPA mill in Schwedt/Oder.

**The vision becomes reality!**

As a milestone in LWC production, LEIPA Schwedt was the first mill ever to produce LWC from almost 100% recovered paper completely online in such high quality that the product caught up with the primary fiber based paper predominating until then.

Since August 2004 LEIPA's PM 4 has been very successfully producing LWC offset grades in the basis weight range 48 to 65 g/m<sup>2</sup>. But the people involved did not rest on their laurels by any means!

**Fig. 1:** EcoSoft Delta.



Spurred on by this initial success and the high qualities attained, the partners followed up their ambition of rotogravure production even more keenly.

So hardly three months after commissioning, the first rotogravure production tests were run on PM 4. After about another three months, so much progress had been made that after successful printing tests, LEIPA booked their first order for LWC rotogravure grades made from 85-90% recovered paper.

That is how LEIPA finally made a paper-making dream come true in the first quarter 2005. Not least thanks to Voith's support in coating and calendering technology with extensive testing and machinery optimization, etc.

**The LEIPA PM 4 calendering concept**

**EcoSoft Delta pre-calendering**

From the calendering point of view, the conditions for high quality LWC offset and rotogravure paper production are established well before film coating. Normally the raw paper is very porous, so that the coating penetrates deeper. This not only leads to poor surface covering, but also reduces gloss and smoothness. To solve this problem, the LEIPA concept includes pre-calendering with a 1x2 roll EcoSoft Delta (Fig. 1) operating at line loads of 10 to 200 N/mm and feed temperatures up to 120 °C. This markedly reduces the surface roughness prior to coating by smoothing out the raw paper surface contour. The roughness after coating is,

**Fig. 2:** SpeedSizer.**Fig. 3:** Schematic PM 4.**Fig. 4:** Janus MK 2.

therefore, less, making the LWC paper easier to calender. The Janus MK 2 calender then imparts it with higher gloss and smoothness.

In parallel to pre-calendering, the thickness cross-profile is also regulated efficiently. On the one hand this improves web runnability in the coating machine, and on the other hand it also improves the thickness profile of the end product. To this purpose the EcoSoft Delta was fitted with a 48-zone Nipcorect roll with

closed-loop Caltronic control system. At 2-sigma thickness values of 0.4 to 0.6  $\mu\text{m}$ , this ensures favourable conditions for the following process stages.

Another pre-calendering highlight is the 45° arrangement of the EcoSoft calender rolls, a familiar Janus MK 2 feature. This innovative frame arrangement, which forms with the two nips a delta, explains its name “Delta”. Apart from practically vibration-free design, it also facilitates upward roll changing using the DeltaLock

developed for this purpose, as well as better accessibility. Furthermore, this kind of 45° design increases the correction potential of the Nipcorect roll because since roll deflection is only 2/3 in the nip direction, therefore, only 2/3 has to be compensated by the Nipcorect roll.

#### Finishing on the Janus MK 2

After coating, the actual finishing at LEIPA is done by means of a 10-roll Janus MK 2 calender. This ensures the right surface characteristics both for offset and roto-gravure printing (Table 1).

Already at the projecting stage, calendering test results clearly showed that an 8-roll Janus MK 2 calender would have been sufficient for offset quality. But inspired by the vision of also producing roto-gravure qualities, we all decided – as papermaking colleagues – to “do the job properly” by installing a 10-roll Janus MK 2 on PM 4 right from the outset instead of using an 8-roll stack.

Thanks to this decision, all the offset grades could now be produced under more moderate calendering conditions. As a result, the reduced calendering load pulses

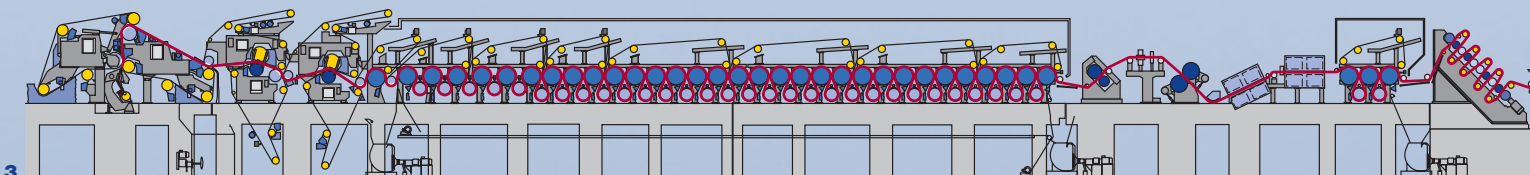



4

not only extend the plastic roll cover life, but also prevent blackening, which with lightly coated grades containing DIP always has to be regarded critically.

As another advantage, the Janus MK 2 had enough potential right from the beginning to produce LWC paper suitable for roto gravure printing. Due to the higher gloss and smoothness required, calendering conditions are much more demanding in this case (higher line loads and feed temperatures). This is also reflected in a higher in-going moisture content.

**Table 2** shows the typical calendering conditions at LEIPA for offset and roto gravure printing papers.

Of course, this breakthrough in LWC roto gravure papermaking was not solely due

	LWC (57 g/m <sup>2</sup> )	
	Offset	Roto-gravure
TAPPI gloss 75°	53 %	~ 59
PPS S10 [µm]	~ 1.4	~ 1.10
Opacity [%]	~ 92	~ 91
Bulk [cm <sup>3</sup> /g]	~ 0.90	~ 0.87
Blackening	~ 52	~ 56

to using the right calendering concept – the entire line had to be optimized for the product in question. Every papermaker faced with high DIP content knows how gratifying it is to deliver a consistently excellent product despite wide fluctuations in recovered paper quality according to origin, even if classified by grades. Particular attention was paid here to strength and wet strength with a high DIP content, both of which drop more rapidly than with primary fibers during remoistening in the coating process.

The transfer system is also important in this connection, because due to the high speeds and demanding stock characteristics, a very sophisticated and finely adjusted system of Fibron vacuum belts and ropes is required for stable and depend-

	LWC (57 g/m <sup>2</sup> )	
	Offset	Roto-gravure
In-going moisture content [%]	~ 8	~ 9
Speed [m/min]	to 1750	1650
Line load [N/mm]	~320	420-450
Feed temperature [°C]	120-180	150-220

able web transfer from the pre-dryer group to the Sirius reel.

Optimizing the coating process and the color composition was yet another step which contributed to the success. Since both of them critically affect the calendering results, they had to be adjusted differently for producing offset or roto gravure grades.

Selecting the right wire was also decisive for optimal roto gravure paper quality. While wire marking initially affected product quality, this problem was solved afterwards by using Voith Paper Fabrics Print-Form HA anti-marking wires, here again ensuring a good basis for efficient calendering.

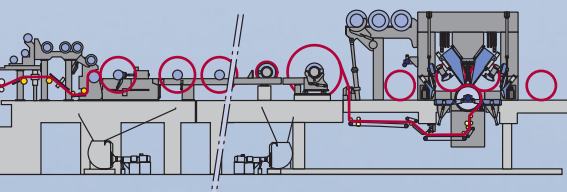



## **Voith keeps customers “Perfect Fit” for the future – with custom-tailored rebuilds**

1

**To stay competitive in the paper industry these days, quality, production and costs are decisive. A Voith rebuild will get your machine back in form again. With modernization measures custom-tailored to your goals, we can optimize your production line performance and update it to the latest state of technology. Our “Perfect Fit” rebuild plan meets all market needs in this direction, and once again proves Voith’s exceptional competence.**



**Ingolf Cedra**

*Paper Machines Graphic*  
[ingolf.cedra@voith.com](mailto:ingolf.cedra@voith.com)



**Four good reasons for a rebuild and modernization**

Today’s global paper and board industry belongs to the very capital-intensive and highly competitive branches. To uphold and strengthen your position or gain new market shares, you must save costs – for example with resources and raw materials – and make your machines more competitive at the same time.

The Voith “Perfect Fit” rebuild plan enables papermakers worldwide to realize individually customized modernization and rebuild measures for every need – whether for higher speed, better quality,

or more efficient and environment-friendly production.

**ProEfficiency**

Higher efficiency is the most frequent rebuild goal of all: especially for older machines and those that already reached their speed limit, production efficiency investments are often the most profitable. The Voith ProEfficiency rebuild plan – covering the entire paper machine from wire section to roll wrapping – minimizes production interruptions and waste for higher efficiency and production at relatively low investment cost.

**Fig. 1:** Pictures speak louder than words: Voith Paper’s “Perfect Fit” plan for customized rebuilds and modernization.

**Fig. 2:** ProEfficiency, ProQuality, ProSpeed, ProEnvironment – Voith has the right solution for reaching every rebuild goal – always a Perfect Fit!

**ProQuality**

To keep up with competitors these days, ongoing improvements are indispensable. And also to gain new market shares, for example with a grade change, dependable quality is the key criterion. From the customer’s point of view, product quality (e.g. with regard to printability) is the most decisive reason for getting orders – not only pricing.

**ProSpeed**

There are two ways to keep paper machines operating cost-effectively despite

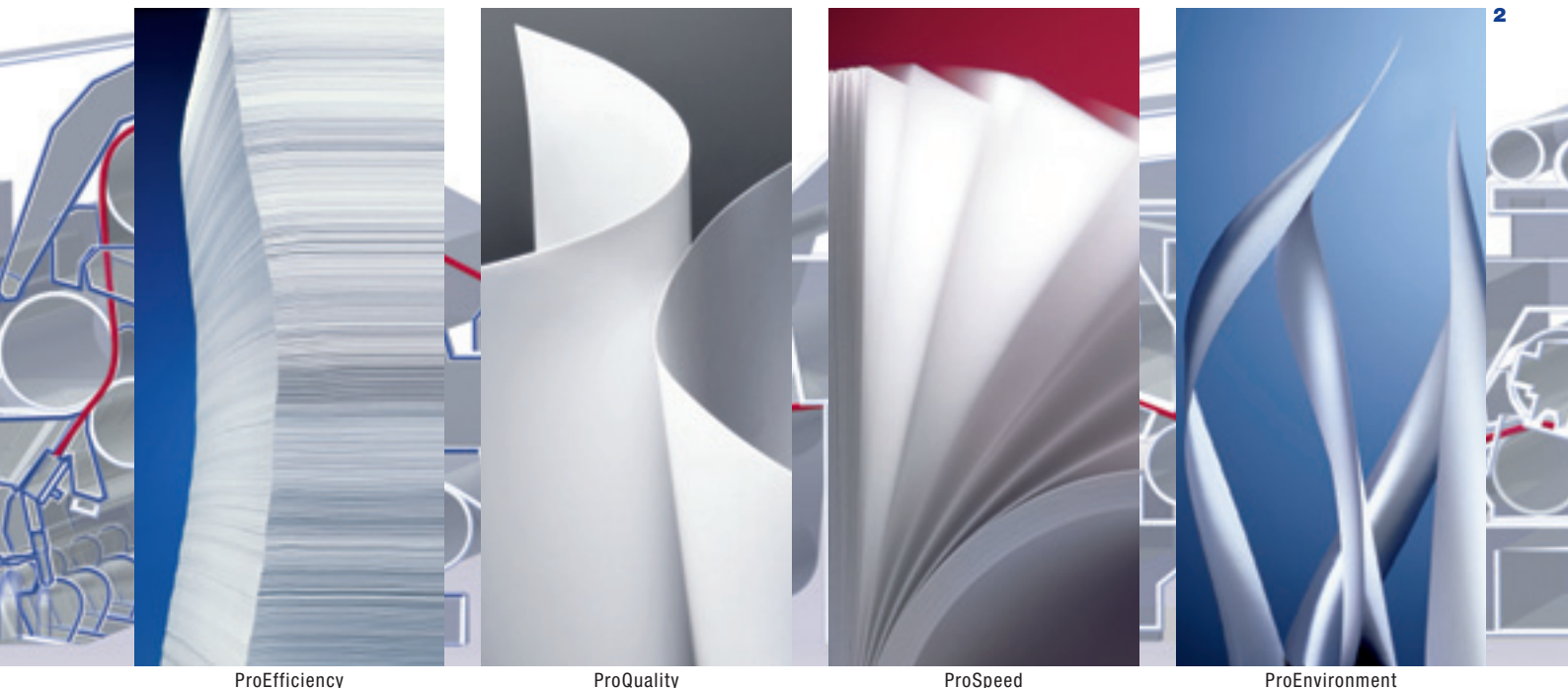

ProEfficiency

ProQuality

ProSpeed

ProEnvironment

lower paper prices: either by a grade change, or by investing in a speed increase. A higher operating speed soon makes the machine profitable again by reducing production costs to a competitive level.

### ProEnvironment

Investments in environment-friendliness are no longer merely voluntary: they are often a matter of survival. Together with rising energy prices, the laws on noise emission, water and air pollution, CO<sub>2</sub> emissions and working conditions are getting tougher every day. Operating per-

mits and certificates are only issued if all these requirements have been fulfilled.

ProEnvironment measures have unexpected potential: investments in appropriate rebuilds in good time not only will help to meet all the legal requirements, but will also reduce your total costs, e.g. through lower water and energy consumption.

### Voith: your Life-Cycle Partner – comprehensive know-how also with rebuilds

Our unsurpassed know-how covering the entire machine life-cycle also pays off for

you with a Voith rebuild. We have been partnering most papermakers worldwide right from the beginning, and know their production processes inside out.

Furthermore, Voith has an independent expert group exclusively concerned with rebuild measures in the paper industry: Rebuilds@Voith.

Whatever your rebuild and modernization goals – higher production, better quality, higher speed, eco-efficiency, etc. – Voith rebuilds keep you fit for the future. Your machine will stay profitable despite paper price declines, market condition and environmental legislation.

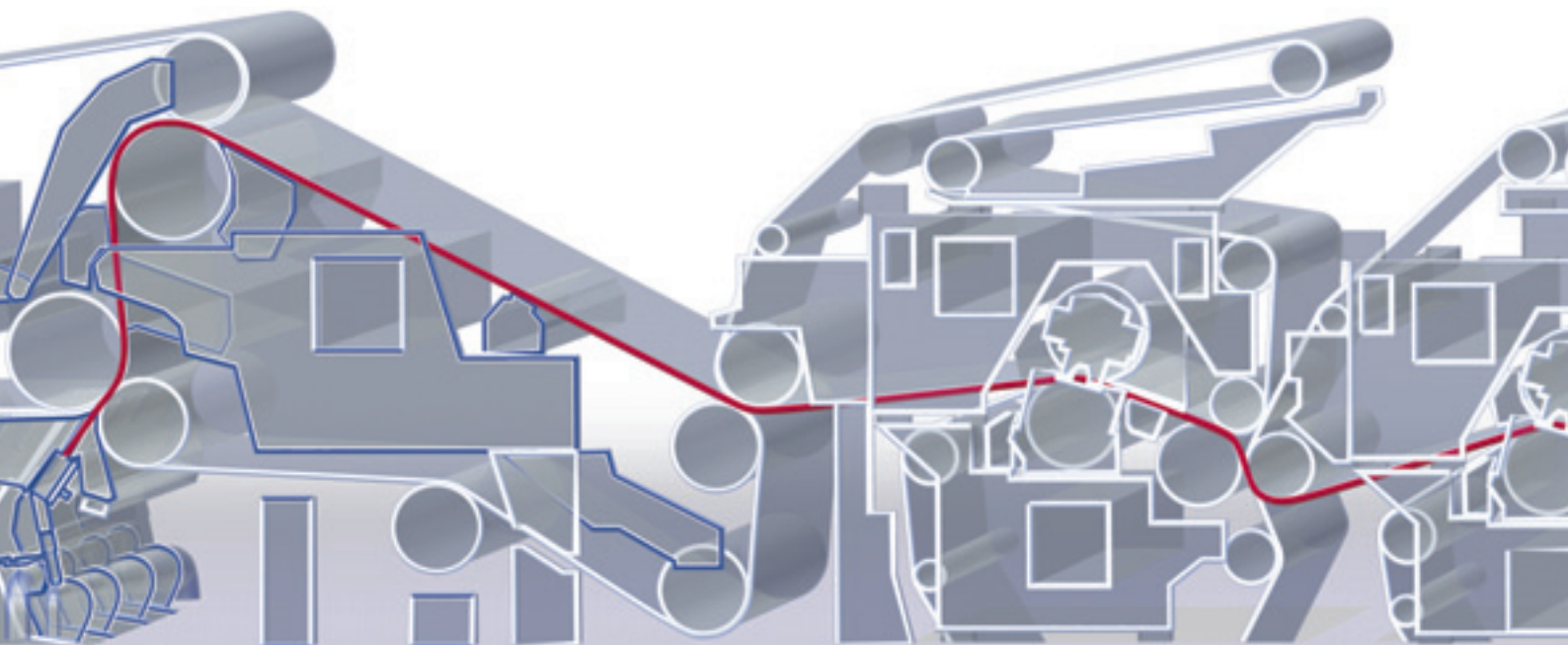



1

## Norske Skog Golbey – Upgrading the heart of the paper machine

**PM 2 at the Norske Skog mill in Golbey France began production in 1999. With a wire width of 10,300 mm it produced 335,000 tons per year. Today, the output of this machine is now about 350,000 tons per year. In October 2005 Voith was entrusted with rebuilding the former to improve product quality. The machine went back on line after only six days.**



**Ulrich Schad**

*Paper Machines Graphic  
ulrich.schad@voith.com*



**Thomas Rühl**

*Paper Machines Graphic  
thomas.ruehl@voith.com*

### Norske Skog – a printing paper giant

The Norwegian papermaking group Norske Skog is one of the world's largest producers of newsprint and magazine grades, with market shares of 13% and 8% respectively in a global market with 60 million t.p.a capacity. Norske Skog has 24 self-owned or shared mills in sixteen

countries on five continents. Working at full production capacity, Norske Skog could easily produce enough paper to encircle the globe seven times each day with a paper strip 1.6 m wide!

The Norske Skog's Golbey mill, centrally located in the French Vosges, is one of the largest newsprint mills with 470 employees.



**Olivier  
Coquet**

**Norske Skog  
Golbey**

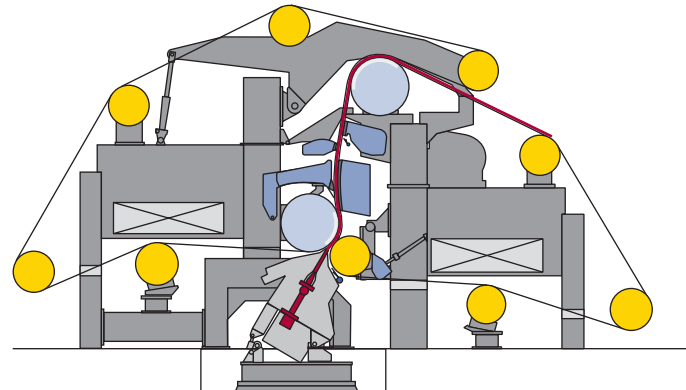

before rebuild

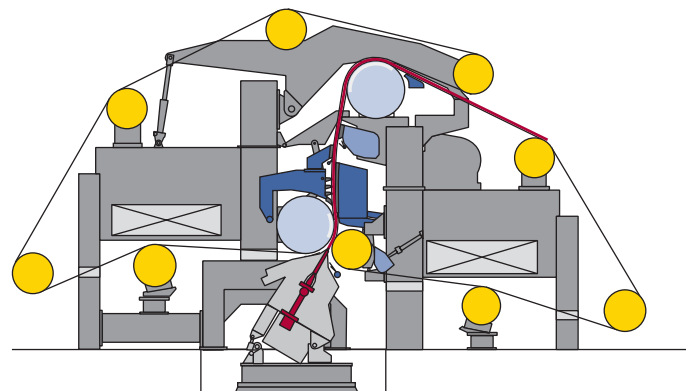

after rebuild

*“In order to minimize rebuild costs, Voith’s offer included retention of the existing elements as far as possible. A key criterion in our decision for this rebuild was that according to investigation results, the solution accepted involves the least risks with regard to paper quality.*

*From beginning to end, teamwork between Voith and Norske Skog Golbey was exemplary. Thanks to the punctual completion of this rebuild, there was no delay in re-commissioning our paper machine.*

*First results show significantly better formation (the Ambertec value has improved from 3.1 to 2.7), with no change in porosity level.”*

### **The rebuild – upgrading with the latest technology**

In October 2005 Norske Skog Golbey placed an order with Voith to rebuild the SpeedFormer HS on PM 2 using latest Voith DuoFormer Technology. The goal was to further enhance newsprint quality in order to keep ahead of increasingly stringent market demands. The rebuild was completed in only six days while the mill was completely shut down.

The main scope of the rebuild was the modification of blade elements in the sheet forming and drainage zone of the former. Existing SpeedFormer elements were replaced with the latest DuoFormer TQv technology components. The following modifications were made:

- The individual ceramic blades on the existing forming shoe were replaced by new composite plate covers using optimized Voith geometry. Even at the highest hydraulic pressures and speeds, these ensure stable sheet formation conditions over the entire machine width.
- The two deflector blades on the top wire were removed and replaced with a unit comprising three loadable forming blades and followed by a new wet suction box. Pressed against the forming shoe, these forming blades help to make the sheet structure much more homogenous by breaking down the large fiber flocks. The wet suction box not only increases drainage capacity, but also enables optimal two-sidedness control of the drainage and thus

**Fig. 1:** Norske Skog Golbey mill in France.

**Fig. 2:** Former before rebuild (above) and DuoFormer TQv after rebuild (below).

**Fig. 3:** Formation improvement with DuoFormer TQv.

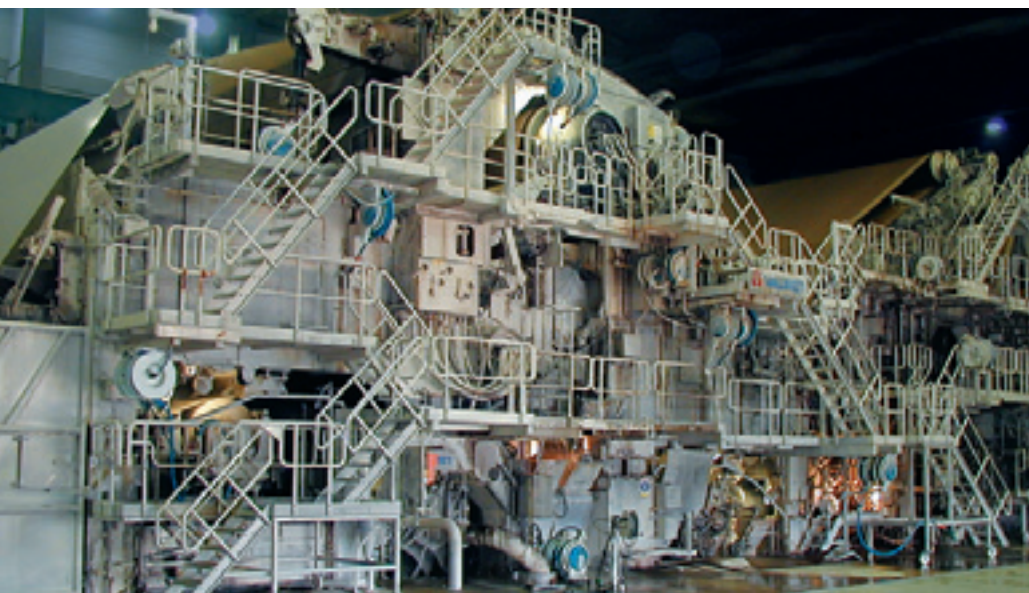

influencing sheet surface quality through the interaction with the existing bottom wire wet suction box.

### **Optimal sheet formation – with minimal expenses**

The main objective of this rebuild was to enhance paper quality by significantly improving uniformity of the sheet structure. For this purpose the existing SpeedFormer was upgraded with Voith forming blade technology. The main element is a unit with three forming blades that are pneumatically loaded during operation against the new composite plate covers installed on the forming shoe. This generates high-pressure pulses that break down the fiber flocks and make the sheet structure much more uniform. Essential for the optimal

functioning of these forming blades is the correct web consistency in the forming blade area. There must be a liquid core between the existing outer layers of the web, i.e. the individual fibers with fillers and fines must still be mobile. This enables greater uniformity by systematic rearrangement of the fibers and also allows a better fillers and fines distribution. To ensure the right web consistency in the formation blade area, preliminary drainage on the forming roll must be adjusted correctly. The main factors here are the stock dewatering characteristic, the basis weight, and the machine operating speed.

Based on the furnish drainage and thanks to the high operating speed, the existing forming angle could be retained for up-

grading to DuoFormer TQv technology. This eliminated any need for modifications to the forming roll, breast roll or headbox and became the greatest advantage for this rebuild concept. In addition, the existing forming shoe body could be reused. By replacing the individual ceramic blades with composite plate covers and installing improved guide-plates on the bottom of the forming shoe, it was upgraded to a state-of-the-art sheet formation element.

All in all, the SpeedFormer rebuild on Golbey PM 2 was an intelligent and cost-effective concept optimized down to the last detail – without having to make any technological compromises.

### **A resounding success: 15% better formation**

Thanks to the reliable and well-proven DuoFormer TQv concept, Norske Skog Golbey now has a state-of-the-art forming unit with high stability and greater drainage capacity. Only shortly after start-up, paper quality at normal operating speed was considerably better. After a short optimizing phase, formation had improved by 15% while retaining porosity at the original level. The improvements in sheet quality have also brought significantly better printing results. Thanks to exemplary teamwork between Norske Skog Golbey and Voith this rebuild was a complete success.

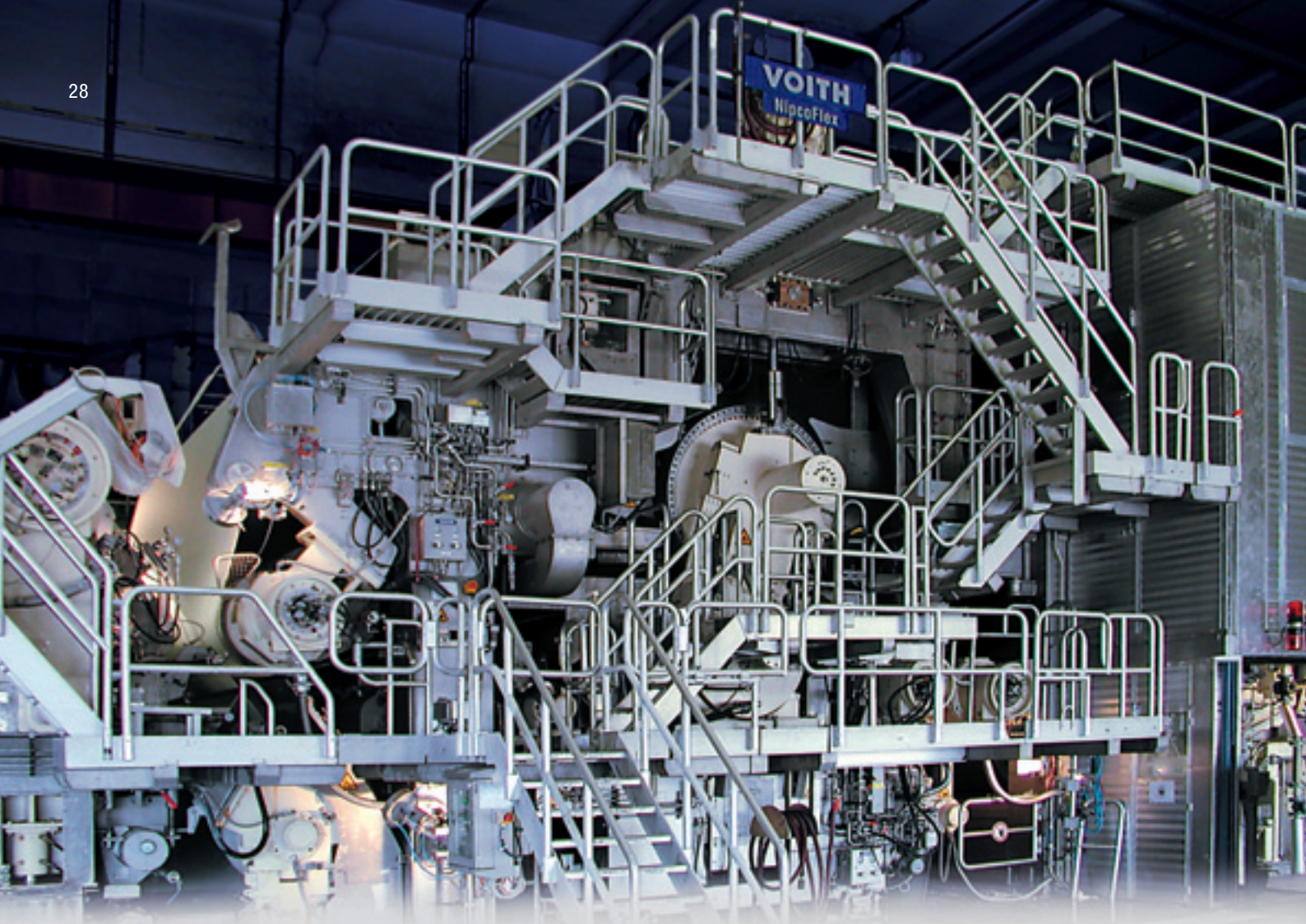

1

## Single NipcoFlex press technology – The cost-effective dryness guarantee for woodfree grades



**Dr. Georg Kleiser**

*Paper Machines Graphic*  
georg.kleiser@voith.com

Some years ago test results showed that drainage in a single shoe-press nip is adequate for about 50% dry content in wood-free grades at acceptable speeds. But at first there were considerable doubts as to whether this technology could be applied in practice. The biggest question was whether today's paper quality and moisture cross-profile requirements could be met with only one press nip. For this reason the single-nip press concept was hardly considered for paper machine rebuilds, despite its very favorable investment and operating costs. Only paper machines for moderate speed and quality requirements were regarded as single-nip press rebuild candidates.

**Fig. 1:** Single-NipcoFlex press on PM 18 at Mondi Business Paper SCP in Ruzomberok, Slovakia.

**Fig. 2:** Dryness and moisture cross-profile development after start-up with new felt.

**Fig. 3:** Water ejection behaviour at the nip outlet.

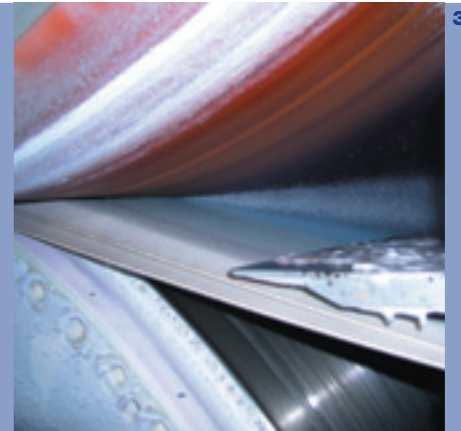
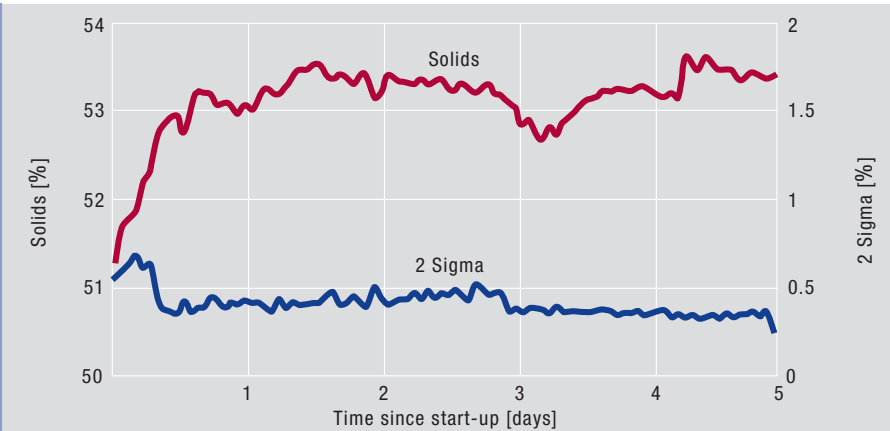

**Amazing speed rises – a rebuild dream comes true**

By boldly using the Single NipcoFlex press for two very demanding rebuild projects, Voith, therefore, set a benchmark. One of these rebuilds, on Ruzomberok PM 18 in Slovakia, brought a speed increase from 800 to 1,400 m/min. The other one was on Ledesma PM 1 (in Argentina) using bagasse, a furnish very difficult to drain efficiently. Both machines produce copy paper, PM 1 in Ledesma also produces woodfree uncoated grades in the basis weight range 60 to 140 g/m<sup>2</sup>. These machines have now been operating for two years since the rebuild, and the outcome of that decision – driven by the very favorable investment and operating costs of a Single NipcoFlex press – is very successful. This article explains why.

**Mondi Business Paper SCP**

*twogether 18* reported in detail on the Ruzomberok PM 18 rebuild. By installing a Single NipcoFlex press, dry content after the press improved from 48% to 53%, and the design speed of 1,400 m/min was attained only a few months after rebuild. Meanwhile production speeds have stabilized at more than 1,500 m/min, with a monthly average around 1,400 m/min. The original speed increase goals have thus been exceeded considerably.

Paper quality in general has developed favorably. With older rebuild projects, the 5% higher dry content now attained was at the cost of substantially lower bulk. Installing this Single NipcoFlex press, however, has hardly affected bulk at all. Likewise the 2-sided roughness difference of less than 10% is an excellent value for copy paper.

The main concern prior to this rebuild was moisture cross-profile development in a single-nip press, where the entire profile stability depends on only two felts and no compensation is provided by additional nips. However the Single NipcoFlex press in Ruzomberok here again delivered impressive results, with 2-sigma values around 0.3% measured directly after the press with run-in felts. **Fig. 2** shows a typical start-up curve with new felts.

Overall, these results are comparable with those using conventional press concepts. Furthermore, there was no steam box for correcting the moisture cross-profile. The felt service life of 21 days attained in Ruzomberok is less than with conventional press concepts, but since only two felts are used, felting costs with the Single NipcoFlex press are nevertheless extremely favorable.

**Fig. 4:** Web run through the Single NipcoFlex press.

**Fig. 5:** Relationship between bulk and roughness with various press concepts.

— Single NipcoFlex press  
— Center roll press

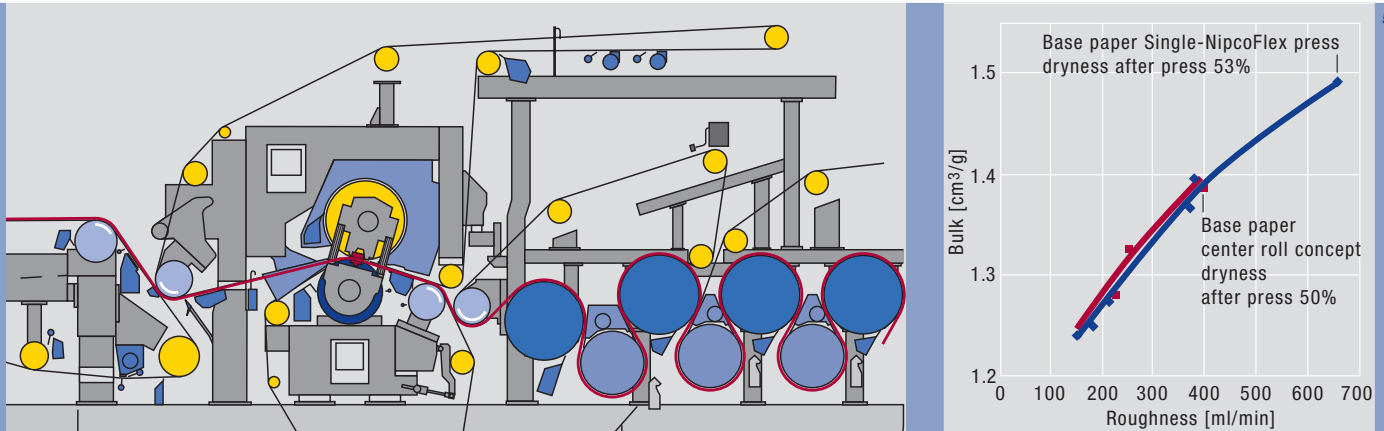

### Ledesma s.a.a.i., Fábrica de Papel

Likewise on Ledesma PM 1 in Argentina, installation of a Single NipcoFlex press significantly improved the dry content. As against 38% with two press nips prior to rebuild, the dry content has now risen to 49% with only one nip. This dryness improvement enabled a speed increase from 680 to over 900 m/min. Another notable effect on this machine is the extremely long felt service life of more than 40 days, well above the norm for a single-nip press.

### The Single NipcoFlex press – a logical innovation

What are the decisive criteria that make the Single NipcoFlex press so successful? First and foremost, Voith designed this press for optimal drainage to ensure ideal conditioning of the felts and roll surfaces

(Fig. 3). The goal was to drain as much as possible of the pressed-out water directly at the nip. Voith Paper was able to apply here years of experience with shoe presses in the first nip of the Tandem NipcoFlex press (Fig. 4). The entire geometry, particular of the drainage zone after the nip, was specifically adapted to single-nip press conditions.

The key design components are:

- An inclined press stack for optimal water drainage into the sump
- A FlexDoc drainage doctor on the shoe press, and a scraper on the mating roll to efficiently remove the entire water in the roll covers
- A wiper bar on the bottom felt to remove dragwater
- Close spacing between sandwich separation and transfer in the dryer section, to prevent folds and runnability problems.

Drainage in the Single NipcoFlex press is much more bulk-retentive than in conventional presses. There are several reasons for this: firstly the high dry content enables high initial wet strength, which together with the closed web run and high-performance web stabilizer system in the dryer section helps to minimize web stress. This enables higher operating speeds with less long-fiber content than in conventional presses. As a result, the strength-improving long-fibers can be replaced with short fibers for greater bulk. Secondly, a bottom-felted straight-through press is often used in conventional press sections for 2-sidedness control. Above all if the straight-through press follows immediately after a shoe press, this usually causes loss of bulk without significantly increasing dry content. And last but not least, the Single NipcoFlex press ensures bulk-retentive drainage by avoiding the excessive pressure peaks occurring in conventional roll nips.



Due to the lack of a center press roll, the un-calendered paper from single-nip presses is rougher than from conventional presses. The higher roughness values are accompanied however by higher bulk. After calendering, the bulk values are comparable with those using conventional press concepts, but the dry content is higher (Fig. 5).

With regard to paper quality, the Single NipcoFlex press has an additional advantage. Due to the fact that the shoe-press nip is felted on both sides and uniformly drained in both directions, excellent 2-sided roughness values are attained (Fig. 6). For copy papers this is particularly important as the 2-sidedness compensation potential is inadequate with conventional calenders because the line forces are too low.

### Success breeds success

In view of the promising results with Single NipcoFlex presses, Voith decided to make this concept a core component of further paper machine rebuilds. Mondi Business Paper were so impressed with this technology after the Ruzomberok PM 18 rebuild, that they decided to use the same press concept again for Merebank PM 31. This machine, which likewise produces copying paper, went back on line in autumn 2005 after the rebuild. At the same time another Single NipcoFlex press went into service, in the USA.

Both these machines reproduced the excellent results attained on Ruzomberok PM 18 with regard to dryness, runnability and paper quality. Fig. 7 gives an overview of reference installations so far with Single NipcoFlex press technology.

Meanwhile the original application window of this press concept – mainly as a

**Fig. 6:** Paper surface roughness development over the felt life-cycle.

— Top side  
— Bottom side

**Fig. 7:** Single NipcoFlex press references.

rebuild measure for moderate speed increases for paper machines producing copy paper – has been considerably extended. Voith now prefers the Single NipcoFlex press for new installations as well as rebuilds for copy or wood-free uncoated grades at speeds up to 1,500 m/min.

Preconditional for high production speeds is however adequate dewatering and strength potential of the furnish. For more demanding requirements, a Tandem NipcoFlex press must be used.

Application of the Single NipcoFlex press for woodfree coated grades is also being investigated. The higher roughness of the base paper from the single-nip press is however a challenge with regard to coated paper surface requirements. By optimizing the felt design and pre-calendering process, this application of the Single NipcoFlex press nevertheless seems feasible. Tests and development work are now underway accordingly.

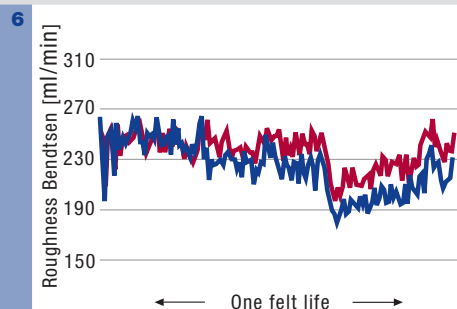

PM	Product	Wire width	Maximum production speed (design)	Start-up
Ruzomberok PM 18	Copy	7,300 mm	1,400 m/min	September 2003
Ledesma PM 1	Copy wf 60-140 g/m <sup>2</sup>	4,220 mm	1,000 m/min	May 2004
Merebank PM 31	Copy wf 60-100 g/m <sup>2</sup>	6,370 mm	1,300 m/min	September 2005
N.N. USA	wf 75-90 g/m <sup>2</sup>	9,500 mm	1,200 m/min	November 2005
Docelles PM 1	Copy wf 60-160 g/m <sup>2</sup>	4,350 mm	1,200 m/min	August 2006

## Voith Drive – Small is beautiful; the innovative drive solution for a more economical paper production



**Diethelm Beisiegel**

Paper Machines Graphic  
diethelm.beisiegel@voith.com

**Voith Drive is an innovative drive concept for paper machines, which offers numerous advantages for the paper production process. The paper production process has always been highly energy-intensive because the moist paper web has to be drained, pressed and dried within seconds. With steadily increasing energy costs all possible energy savings potentials should be utilized to make paper production more economical and to be able to stand up to the cost pressure. With Voith Drive, paper producers come far closer to meeting their demand for energy-saving paper production.**

At production speeds of up to 2,000 meters per minute the paper web is led over a large number of rolls, which have to be driven by powerful motors. Traditionally, the transmission of power to the rolls takes place with the aid of drive elements, such as universal-joint shafts, gear units and couplings.

Voith Drive is the drive solution of the future, as it meets the required properties of a modern drive, with the omission of all of the drive elements that have been required up to now. Through the compact shape of the Voith Drive the space requirement in the paper machine building is drastically reduced (Figs. 2 and 3).

Voith Drive is simply slipped onto the roll journals – and this not only on the drive side of the paper machine, as is the case with the traditional drive. Voith Drive can also be installed on the tender side. This results in flexible installation concepts, making Voith Drive ideally suited also for rebuilds. It can be installed with little installation work within short rebuild times. Voith Drive is universally applicable and provides the necessary drive dynamics on all paper and spreader rolls, in the dryer section, calender and reel section, and on the rope drives.

The Voith Drive motors are temperature controlled via a closed water cycle with upstream dirt filter and delivery pump.

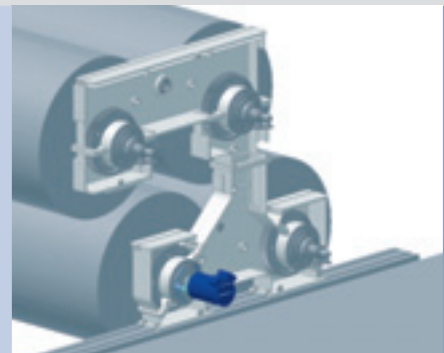
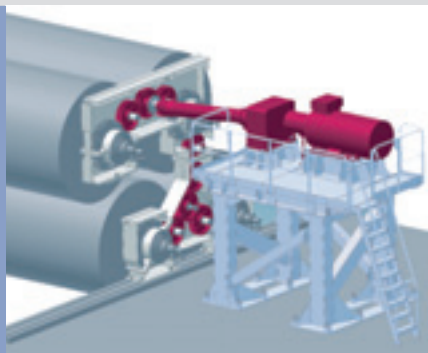

**Fig. 1:** Voith Drive.

**Fig. 2:** Traditional drive with frame-mounted gearing, universal-joint shaft, gear unit, coupling (red).

**Fig. 3:** Voith Drive (blue).

**Fig. 4:** Compact design, simple installation.

**Fig. 5:** Energy savings potential.

**Fig. 6:** LEIPA-Schwedt PM 4, Janus MK 2 calender.

That leads to high power densities. Even continuous operation at crawl speeds is, therefore, possible without any problems (Fig. 4).

Through the omission of the gear units and frame-mounted gearing, overall efficiency will be up to 5 per cent higher with the Voith Drive, reducing, therefore, energy consumption of the paper machine considerably. But it is not only the energy costs that can be reduced by the use of the Voith Drive. The operating costs for maintenance and warehousing also go down, as wear-intensive gear wheels become a thing of the past and the stocking of spare parts can be optimized by the omission of the mechanical drive elements (Fig. 5).

From a cost aspect, the Voith Drive is, therefore, the right choice. In addition, environmental aspects and working environment for the operating personnel on the paper machine will also see distinct advantages.

Through oil lubrication of the gear wheels on traditional drives, especially on older paper machines, there were frequently undesired losses of oil, which led to con-



tamination on the paper machine framing. As Voith Drive dispenses with gear wheels, oil lubrication is not required and the problem of oil leakages is eliminated. Not only are, therefore, the costs for high oil consumption saved, but the environmental balance of the paper machine is improved.

Besides this environmental aspect, Voith Drive also offers distinct advantages for the operating personnel on the paper machine. In the paper machine building the workers are exposed to considerable noise pollution. Due to the backlash-free transmission of power without mechanical drive elements, Voith Drive provides improved paper machine runnability, and the noise level in the paper machine building is significantly reduced.

Voith Drive will convince you by its excellent references. The drive concept runs successfully in many paper machines, coating machines and re-reelers worldwide since the year 2000, and more than 300 Voith Drive motors have been sold to date. For example, 30 Voith Drive motors of different size on LEIPA-Schwedt PM 4 provide the necessary drive dynamics and increase the overall efficiency of this ultramodern LWC production line (Fig. 6).

To summarize: from an economy point of view, Voith Drive is the drive solution of the future and has proven successful worldwide in commercial operation.

Further information is available at: [www.voithdrive.voithpaper.de](http://www.voithdrive.voithpaper.de)

<b>5</b>	<p><b>Asynchronous motor and gear</b>                  100 kW                  1,450 rpm                  Motor efficiency: 94 %                  Gear efficiency: 96 %  <b>Over-all efficiency: 90 %</b></p>	<b>90 %</b>	<p><b>Asynchronous motor and gear</b></p>	<b>95 %</b>	<b>5% Energy savings</b>
	<p><b>Voith Drive</b></p> <p><b>Voith Drive motor</b>                  100 kW                  4,750 Nm                  200 rpm</p> <p><b>Over-all efficiency: 95 %</b></p>	<b>5 kW · 8,550 h/y = 42,750 kWh/y</b>			



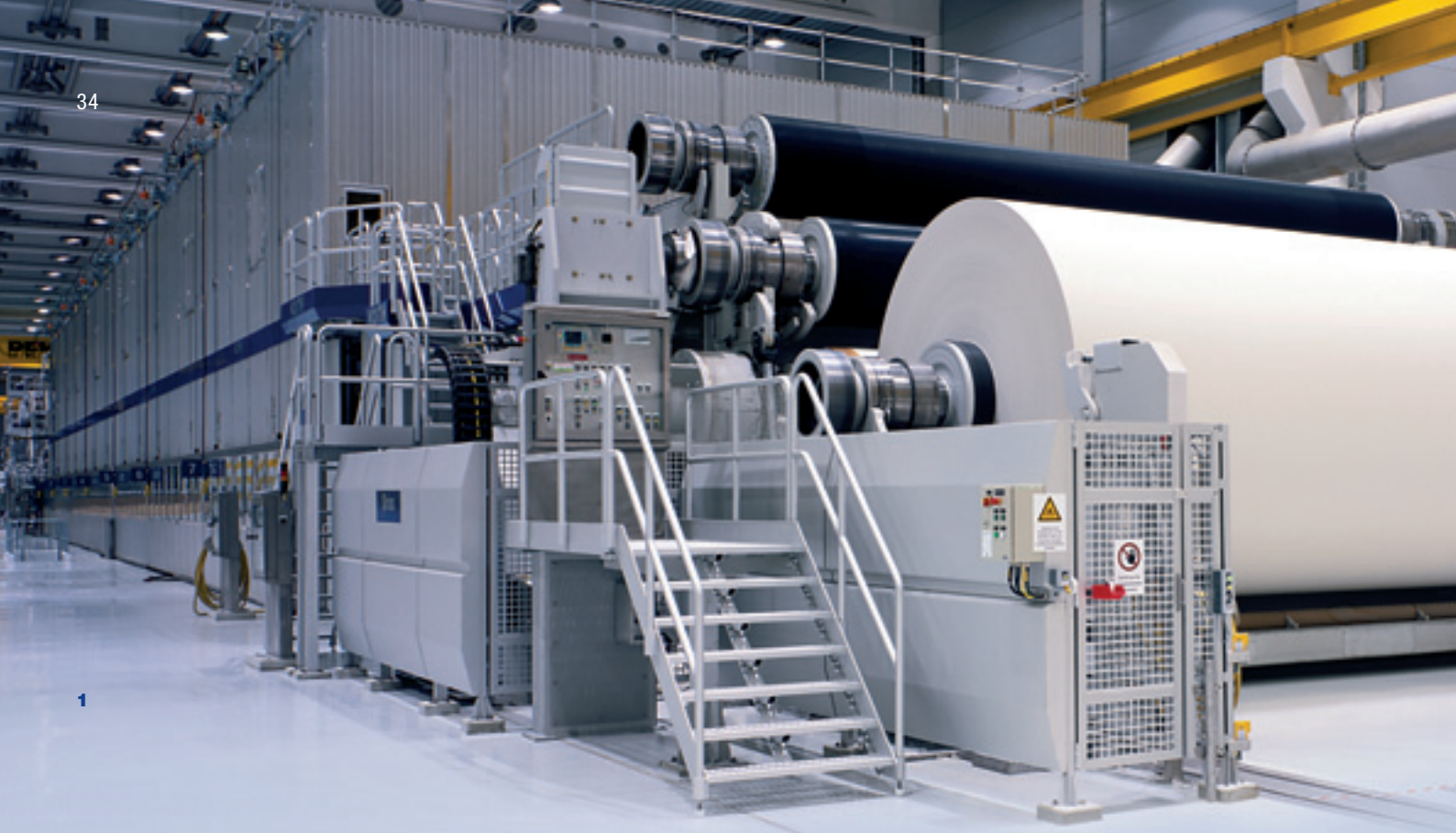

## RollMaster – new possibilities for optimizing and troubleshooting reeling systems

Changes in the paper production process and increased demands in quality and efficiency in the last few years have had an impact on reeling systems. Thanks to improvements in process technology, the existing offline finishing processes (coating, calendering) can be performed online, which means the number of machine-wide reeling systems can be reduced considerably. Modern reeling systems, such as the Sirius, are industry standard today (Fig. 1).

At the same time, changed paper characteristics, such as reduced smoothness, combined with higher machine speeds have reduced wind-up capability. Increased density as well as larger parent roll diameters have resulted in a considerable increase in the paper load on the parent roll core. Combined with the increase in the number of layers, there is a greater probability of layer displacements (winding defects). The total amount of reject per day can be minimized by reducing the number of reeling systems and with improved machine concepts.



**Dr. Jörg Maurer**

Paper Machines Graphic  
joerg.maurer@voith.com



**Josef Wigand**

Automation  
josef.wigand@voith.com



**Fig. 1:** Modern reeling systems, such as the Sirius, are industry standard today.

**Fig. 2:** Reeling parameters.

**Fig. 3:** Data from the quality control system.

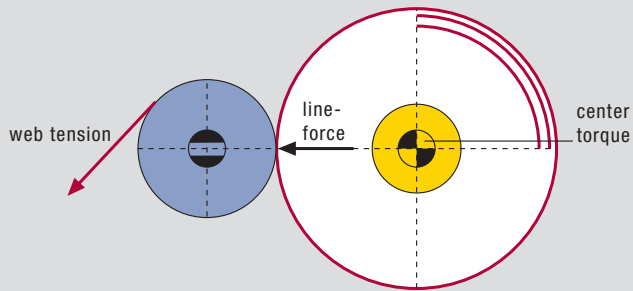

**RollMaster – the optimization tool**

To make the machine’s process cycle more transparent, an analysis tool is needed for lasting control of the various winding and process parameters as well as of changes. For this reason, Voith has developed the RollMaster, an automation tool for analysis and measurement of all parameters that influence winding quality. RollMaster is not only used for machine-wide reels (paper or coating machines, re-reelers), but also on winders. The system can also be easily added to existing machines.

**Functions**

The quality on the reel is influenced by various parameters. On the RollMaster, the reeling parameters of linear load, center torque and web tension (Fig. 2) are specified as freely programmable reference curves over the diameter.

A special feature of the system is that all relevant data for operating the reeling

system are recorded and presented together on a single platform:

- Parent roll data (density, diameter, linear footage)
- Drives (torques, speeds, tension regulators)
- Linear load system (pressures, positions, angles)

- Binary signals for monitoring the sequences.

In addition to the pure machine control data, process-relevant data, such as statistical variables (loss times, production quantities) and quality data are also recorded. Fig. 3 shows data from the quality control system.

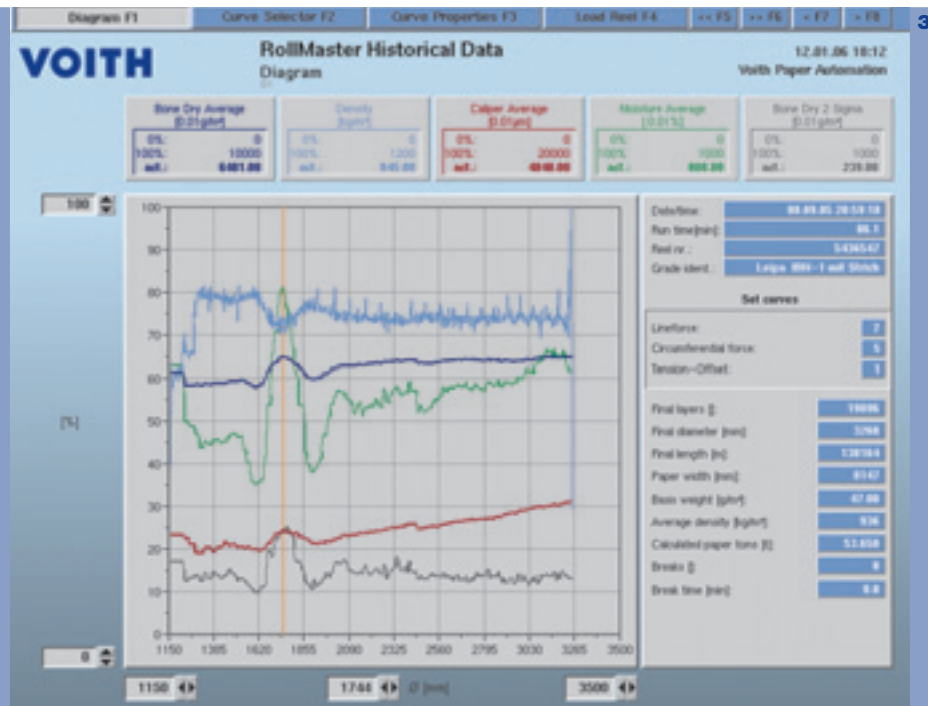
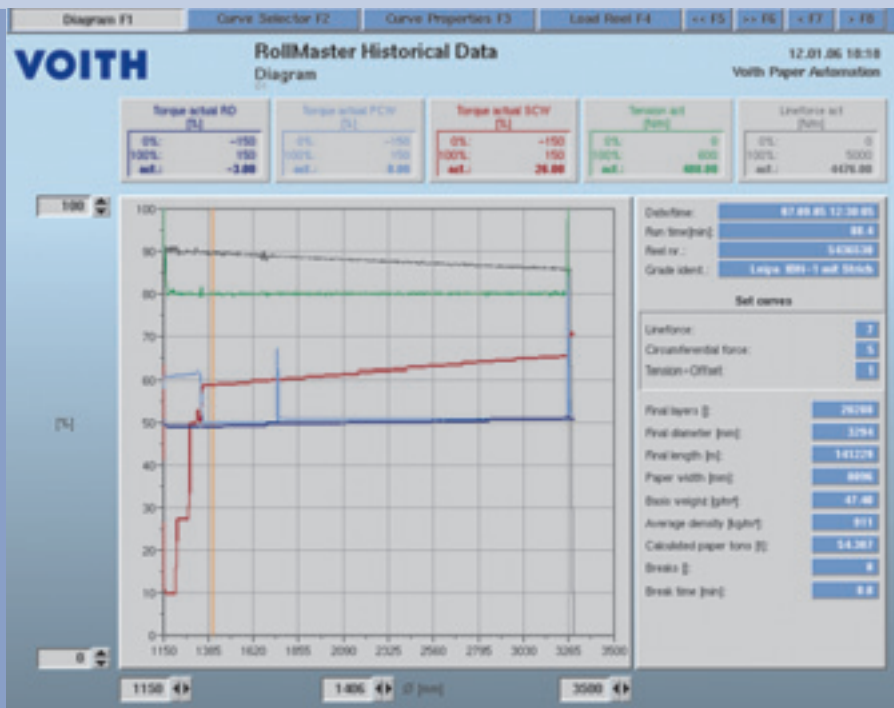

Fig. 4: Winding parameters/set-point curves.



In addition to the data measured via sensors in the peripheral field, information from other systems is used as well (e.g. drive control or quality control system). Overall, around 300 channels are available for data recording. If needed, an alarm can be issued via limit value monitoring. The data are recorded in real time. Only the signals from the process control system are delayed by their cycle time.

Apart from online visualization, all data measured of each parent roll are stored in two ways:

- layer-dependent (measurements are determined through a configurable number of layers, typically 10-30) and

- time-dependent (high-resolution in the millisecond area).

The system's reeling results are documented completely at all times over many years. If a disturbance occurs, it makes troubleshooting correspondingly much easier for the various problems that can occur on a reeling system.

### Operation

Visualization in the RollMaster takes place via multi-window technology. Drag-and-drop functions support operation, including preparation of freely configurable set-point curves (Fig. 4). The individual steps, operation and analysis possibilities can be recorded intuitively.

## Operational experience

### Remote access

All functions (operation, parameter setting, installation) can be controlled via remote access. Disturbances can be analyzed from the Voith company location using remote data transmission. Fast VPN connections help to simplify remote diagnosis. There is no difference visible in speed between the loading and build-up time of the images on the machine computer and on the computers connected via remote data transmission. An advantage of remote access is the fact that the appropriate specialists can be brought in for troubleshooting and problem solving for each area.

### Start-up

The paper machine and drive components, including controls etc. are often supplied by different manufacturers. In case of reeling problems at machine start-up, trouble shooting is, therefore, rather time consuming and faults are difficult to locate. It often results in personnel-intensive and costly visits after machine start-up, especially with regard to the automatic turnup sequence. RollMaster as a diagnosis tools makes it possible to track defects quickly. The high-speed-recording function of the RollMaster allows the monitoring of details in drive control and implement optimization measures immediately as long as the corresponding technical personnel is on site.

**Fig. 5:** Time recorder – binary signals.

**Fig. 6:** Measurement history – traceability of changes in the process.

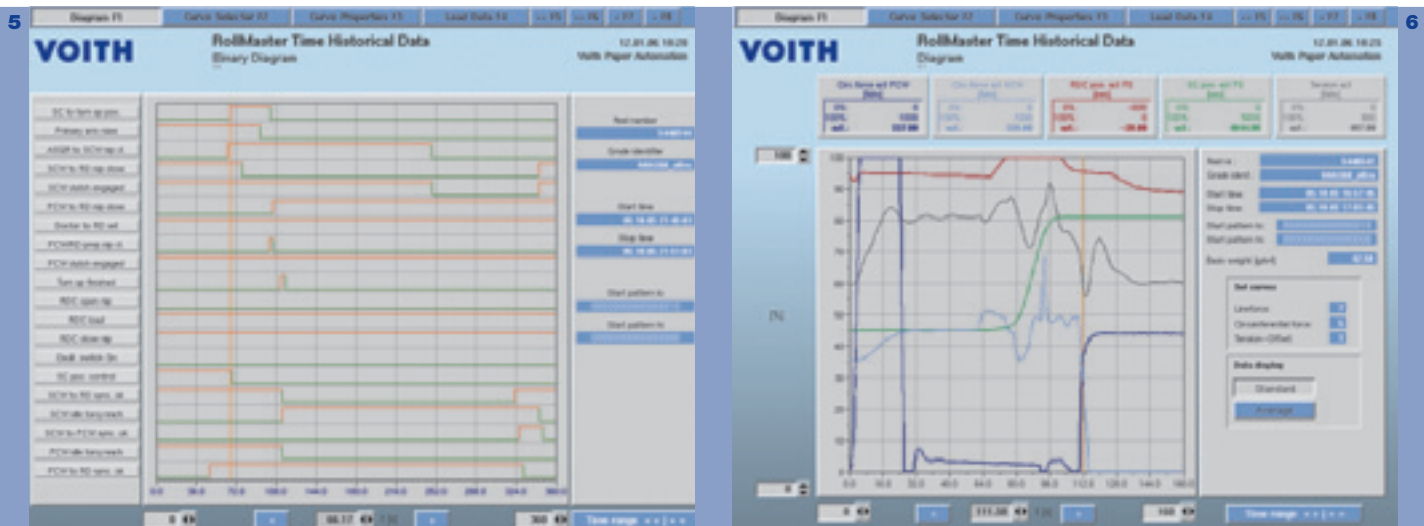

### Optimization and troubleshooting

The high-resolution measurement and data storage provide various opportunities for the RollMaster user that are not possible to the same extent with other systems.

The real-time recording and storage of binary signals of the sequence control permit diagnosis and control when changes occur in the sequence. Fig. 5 shows time recorder – binary signals. In this way, effects such as flickering signals can be discovered.

Also, by the real-time recording of analogue signals (Fig. 6 shows measurement history – tracing changes in the process), effects can be analyzed that are lost in the resolution of DCS trends, such as drops in web tension during turnup. The

high resolution also makes it possible to analyze higher frequency oscillations (e.g. hydraulic, drives). Both signal types (analogue and binary) can be depicted together on a diagram.

Free channels in the system can be used for any desired signals (also from other machine sections). All channels can be freely configured and their parameters set (signal name, unit and range). When winding problems occur, the availability of machine data and data from the quality control system on one platform makes a simpler correlation between problems in machine control and in the paper profile possible.

The automatic grade-dependent specification of reference curves ensures the correct selection of machine parameters for optimal winding hardness and mini-

mizes the probability of an incorrect parameter selection. Storage of all this data over a long period of time ensures the build-up of winding-related technological know-how.

### Summary

Higher technological demands and an increased consciousness of efficiencies ensure a growing importance for control of winding parameters and diagnosis on reeling systems. With the RollMaster, the paper maker is able to use the winding parameters that are optimized for the demands of the respective paper grade and can also minimize machine downtime during disturbances and changes within the production process.

## Voith Paper Rolls Division – Your fast, flexible and reliable partner around the roll



Voith has always been a partner to the worldwide paper industry with technical innovations, high-performance components and comprehensive know-how. As one of the seven interlinked Voith Paper Divisions, Voith Paper Rolls is the world's leading roll technology specialist for all papermaking needs, whether for graphic and specialty grades, tissue, or board and packaging papers. But what exactly is a roll technology specialist? We asked Andreas Endters, Executive Vice President of the Voith Paper Rolls Division, to explain this in more detail.

Division Head  
**Andreas Endters**  
Executive Vice President  
Voith Paper Rolls

*What does Voith Paper Rolls have to offer the paper industry?*

**Andreas Endters:** Voith Paper Rolls supplies the paper industry with all types of rolls, high-performance covers and coatings. We are able to provide comprehensive Tissue Cylinder Service and roll services in our worldwide service centers or in the mills, directly on the paper machine.

*Does Voith Paper Rolls manufacture and supply rolls for all kinds of paper machines?*

**Andreas Endters:** Certainly. We produce suction and press rolls, guide rolls, dryer cylinders and reel spools for every type of machine. All of our new rolls are optimally

designed and manufactured for each individual application, taking into account the latest developments and operating conditions of both new machines and rebuilds. We also optimize existing rolls to enhance machine efficiency and reduce maintenance costs.

*What benefits do roll cover and coating innovations provide the customer?*

**Andreas Endters:** Voith Paper Rolls cover and coating innovations set benchmarks for all applications, bringing improvements in all sections of the paper machine. These improvements include, for example, better sheet release and lower draws, together with better and more uniform drainage. Coating and sizing are therefore more uniform, and calendering





results are optimal. None of these improvements would be possible without perfectly tailored roll cover technology.

Our innovations for the paper industry are only possible thanks to interdivisional teamwork among the Voith Paper development engineers, technologists and experts. A good example of this fruitful teamwork is our new Solar generation of polyurethane covers for press and suction press rolls.

*Another Voith Paper Rolls innovation is the Virtual Reference Grinding “VRG” technology. The VRG was developed together with the Fraunhofer Institute and has just been awarded the Fraunhofer Research Prize. Can you tell us more about this development?*

**Andreas Endters:** I’m glad you mentioned that. VRG is a revolutionary innovation, substantially improving grinding quality with minimal material removal. It also enables considerable cost savings by reducing shut-down times up to 30%. The Tissue Cylinder Service does not only involve grinding the tissue creping and smoothing cylinders, but it also includes inspections and diagnoses, repairs and coating with the latest technology. All of which is done by experienced specialists who are thoroughly familiar with the strict pressure-vessel safety regulations.

*Does Voith Paper Rolls operate globally?*

**Andreas Endters:** Of course! We have 26 Voith Paper Rolls service centers worldwide. Reliability, flexibility and

speed are of absolute priority at every single one of them, as well as at all of our on-site assignments – 24 hours a day, 365 days a year.

*What do these service centers offer?*

**Andreas Endters:** The Voith Paper Rolls team of experienced specialists can overhaul and rebuild all rolls independent of manufacturer or type. Our on-site field service covers fast and reliable roll changes, repairs right on the paper machine, dryer cylinder grinding and coating, as well as the mechanical treatment of entire dryer sections including balancing.

*Many thanks for this interesting interview, Mr. Endters.*



## Voith Paper Rolls Launches the Latest Generation of Polyurethane Covers

**Voith Paper Rolls, the unsurpassed leader in polyurethane roll cover technology, has introduced Solar, a new generation of superior polyurethane roll covers. Solar series covers have enhanced properties over previous generations of polyurethane roll covers and can show clear benefits for papermakers.**



**Paul McCarten**

*Rolls*  
[paul.mccarten@voith.com](mailto:paul.mccarten@voith.com)

Roll covers serve many purposes in the press section of a paper machine. Along with corrosion protection of the shell and an economical, renewable surface, roll covers have the capability of providing a more uniform nip pressure (compared to metals) when confronted with local variations in sheet thickness and felt compression, and have less sensitivity to crown errors. Additionally, covers may allow higher loads (and higher impulse and dwell time) with the same peak pressure. In order to effectively perform their function, roll covers need to have high abrasion resistance, hardness stability and durable bonding. High performance polyurethane roll covers meet these requirements. Their combination of abrasion re-

sistance, toughness and durability make them the cover of choice for press and suction press rolls on demanding paper machines.

Voith Paper Rolls has been the undisputed leader in polyurethane cover technology since the advent of the use of polyurethane covers on paper machine applications. Continuing endeavors by Voith's Research and Development engineers, scientists and technologists have produced generations of polyurethane products, each with enhancements on the past. Today G2000, Aqualis, PolyDyne and PolyMax are the industry standards for demanding applications on press, suction press and film press roll positions.

The Solar series, SolarPress for press rolls and SolarFlow for suction press rolls builds on this legacy of technological innovation. The Solar series covers have been designed for demanding pressing applications and have superior properties compared to other polyurethane products. These improvements have been demonstrated in field trials on many applications, both in Europe and in North America.

Solar combines a superior polyurethane top stock with Voith's proprietary AST bonding system to produce a cover with unrivaled performance, reliability and durability. The unrivaled hydrolytic stability and durability of the AST bonding system has been established over a number of years. Many mills that had gone to uncovered stainless steel suction rolls due to failures of conventional polyurethanes in the past have re-covered their rolls with Aqualis due to the outstanding durability of the AST system.

Some of the properties where Solar shows even further improvements over previous covers include hydrolytic stability and dynamic performance. In the hot, wet environment of a paper machine press sec-

tion or size press, polyurethane covers absorb water. Depending on the temperature of the application and chemicals being used, there can be softening of the roll cover. Laboratory testing of Solar has demonstrated its superior resistance to hydrolysis compared to previously available products. **Fig. 1** shows the change in ultimate tensile strength of a number of 10 P&J polyurethane press roll compounds with exposure to hot water. The superior hydrolytic resistance of the Solar polyurethane top stock is readily apparent. It maintains its strength and toughness in an environment where other products degrade and weaken substantially.

This superior material stability results in a cover with minimal softening and excellent resistance to groove closure when running in a paper machine. The cover maintains its properties during its time in the machine resulting in optimal performance through the entire running time.

Solar also has high abrasion resistance and, due to its high hydrolytic stability, maintains this abrasion resistance over time. **Fig. 2** shows the abrasion resistance of Solar at 15 P&J along with some other materials. Not only is Solar superior

**Fig. 1:** Tear strength retention.

**Fig. 2:** Abrasion resistance of cover materials.

**Fig. 3:** Material hysteresis.

to the latest generations of super abrasion-resistant rubber covers, it is also superior to premium polyurethane covers.

The superior cover material results in enhanced performance on a multitude of paper machine applications. On press rolls, the superior toughness and hydrolytic stability allows configuring of new, more open surface drill patterns for improved water removal. The Solar series' high abrasion resistance results in a cover that maintains its profile and minimizes groove wear and hole cupping, thus providing consistent, efficient dewatering capabilities during extended runtimes. Papermakers see superior performance of the cover from the day it is installed in the machine and performance is maintained through the whole running time.

For elastomeric covers on paper machine press sections, the behavior of the material under cyclic loading is critical. As the cover is compressed and relaxed going through the nip, part of this compression work is converted into heat inside the cover. The lower the hysteresis of the cover material (typically measured instrumentally as  $\tan \delta$ ) the lower the energy absorbed and converted to heat and the

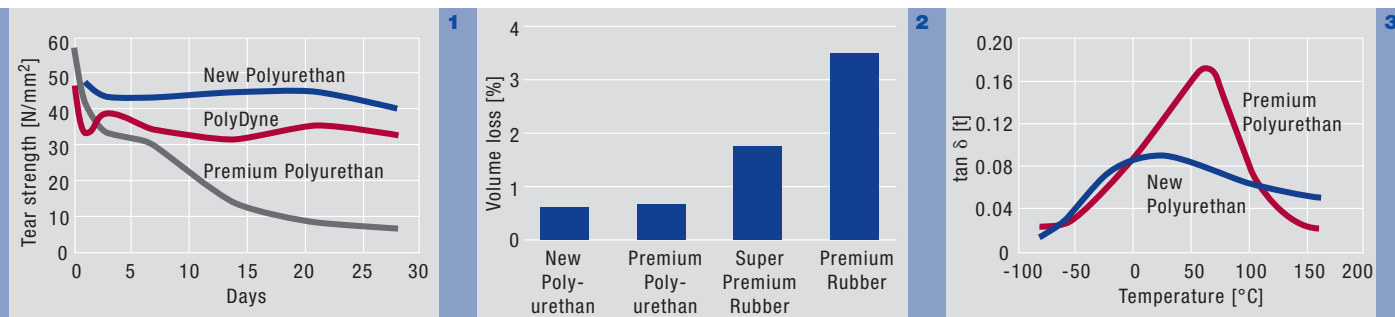

**Fig. 4:** A SolarFlow cover on a suction press roll.

**Fig. 5:** Inspecting a SolarFlow cover.

cooler the cover will run. Materials with too high a hysteresis will fail on high load, high speed applications.

As can be seen on **Fig. 3** Solar has, compared to other polyurethanes, superior dynamic properties. Solar approaches the dynamic performance of G2000 also at higher P&J values. The benefits of these superior dynamic properties have been realized in a number of ways. Solar covers are running very successfully in hydraulic-load demanding positions in graphic paper machines as well as in packaging paper machines, in some applications even without cooling water.

Customers expect significant benefits from Solar on a wide variety of applications including, among others, grooved press rolls and blind drilled and grooved press rolls on graphic paper machines and blind drilled press rolls on packaging paper machines and on pulp machines. The improvements can be illustrated with a couple of examples.

### **SolarPress, the new press roll cover**

A linerboard producer in the Northern U.S. had a history of cover failures on a highly loaded press (“LNP’s”), one of the most demanding positions on paper machines. Covers on these positions are prone to failure. The typical failure at the mill in question occurred as the rubber covers in use wore down. Non-uniform wear would result in a localized increase in line load such that delaminations of the top stock would occur.

The superior properties of SolarPress allowed the covers to be installed in the application without requiring cooling water. Polyurethane covers have now been installed in both positions in the press and are running well with the water cooling turned off, providing considerable cost savings for the customer.

### **SolarFlow, the new suction press roll cover**

Due to the chemical environment as well as high steam levels, a testliner producer in Austria experienced severe wear on conventional blind drilled grooved polyurethane suction roll covers (less than 4 months running time). Aqualis provided an improvement in run times (6 months on machine).

Only SolarFlow could achieve the expectations of more than 12 months on machine. After the prolonged running time the surface appearance was better than competitive covers after 2 months on machine!

At Voith Paper we continuously use our process know-how and Research and Development to bring innovative new products to market. The Solar series of polyurethane covers is our newest product line to meet the increased performance requirements of our customers.

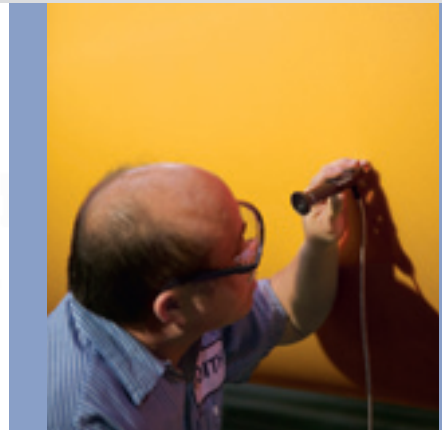
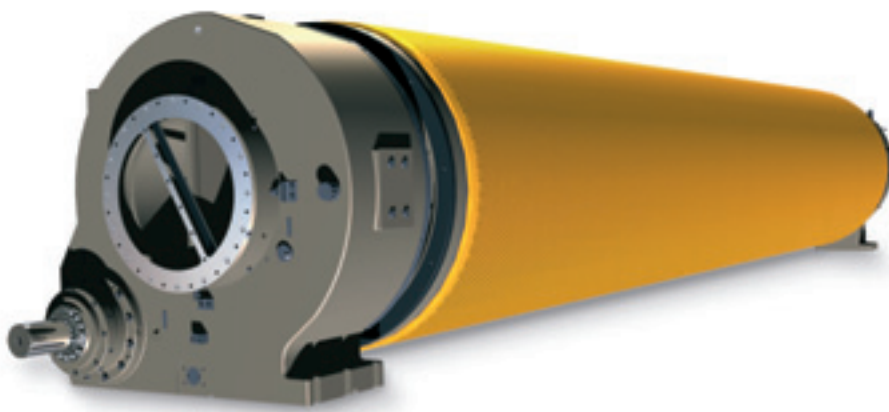

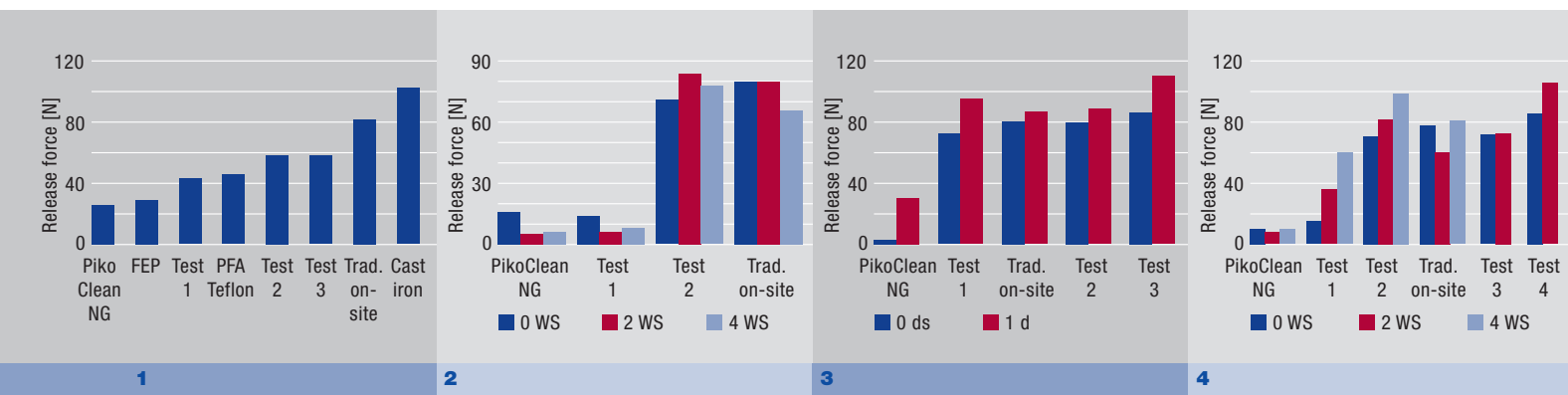

## PikoTeknik developed next generation non-stick roll coating



**Ingmar Vesterlund**

*Rolls*  
[ingmar.vesterlund@pikoteknik.com](mailto:ingmar.vesterlund@pikoteknik.com)

**PikoTeknik Oy, a member of the Voith Paper Rolls group has introduced a next generation on-site coating solution, which was developed in cooperation with technology specialists of the industry to solve dirt problems in the drying section of the paper machine. “The new PikoClean NG, which is the result of several years of research, is the first coating applied with the HVOF method at the customer’s facilities that shows the best non-stick and release characteristics even without oven treatment”, says PikoTeknik Oy.**

The extraordinary chemical, corrosion and heat resistance of the doctorable PikoClean NG coating was proven in thorough laboratory tests and under actual production conditions. The main areas of usage of the coating are dryers and cooling cylinders as well as guide rolls.

The product development of PikoClean NG is the result of the recent enormous progress in material technology. With the help of the new generation coating PikoTeknik is now able to combine improved characteristics with higher speed and flexibility of on-site coating.

**Fig. 1:** Release force.

**Fig. 2:** Heat transfer test.

**Fig. 3:** Sulphuric acid test.

**Fig. 4:** TMP test.

### Cooperation between research and industry

Participants in the research and development project for PikoClean NG were the Fibre and Particle Engineering Laboratory of the University of Oulu, Tampere University of Technology, Finnish paper mills and Voith.

The multiphase research project involved the analysis of the adhesion of different types of deposits and the comparison of different coating material options by measuring their release forces and testing their release functions, wear, corrosion and chemical resistance and heat transfer characteristics in conditions corresponding to actual machine conditions. New research and measuring methods were developed for the project, which enhanced the comparison of existing and new coating materials.

PikoClean NG was a clear test winner in the tape test that measured the release force (Fig. 1), the heat transfer test (Fig. 2), the sulphuric acid test (Fig. 3) and the TMP test (Fig. 4) that measured the operational function under conditions favourable to the growth of microbes.

Thanks to the state-of-the-art products and methods PikoTeknik has grown quickly into a global company. PikoClean coatings on drying cylinders are already standard in the new Voith paper machines. In addition to coatings applied to paper machine cylinders and rolls at the customer’s facilities PikoTeknik offers drilling, machining, measuring and balancing services on-site in the paper machine as well as at their Service Center in Parhalahti near Pyhäjoki.



## Endura series – Hard coatings for Yankee and MG Cylinders

**Hard coatings preserve Yankee and MG Cylinders and prolong their service life. Furthermore, coated cylinders can improve paper quality. To these ends Voith Paper Rolls has developed the Endura series of tailored dryer cylinder coatings to meet the rising demands of the paper industry.**



**Uwe Becker**

Rolls  
uwe.becker@voith.com

Voith Paper Rolls can offer a suitable coating system for every application:

**EndurAll – the optimal surface coating for tissue creping cylinders**  
**Endura MG – the optimal surface coating for MG cylinders**

Prior to market launch all new Voith Paper Rolls coatings undergo extensive testing, particularly for wear resistance on a specially developed test facility. To ensure realistic test conditions, a doctor runs against the coating at a line force, which can be increased up to ten times the normal load. Corrosion resistance is tested

on a standardized facility enabling a wide variety of test conditions as near as possible to those on the paper machine in question. Local machining of the hard cylinder surface is also investigated and optimized, as well as its compatibility with the specific papermaking process in each case.

Voith Paper Rolls service specialists apply these coatings exclusively on site at the paper mill. To this purpose they take with them a grinding machine, sandblasting and coating equipment, weighing about 30 tons in total.

**Fig. 1:** Endura application process.

**Fig. 2:** Endura MG.

The overall application process – pre-grinding, sandblasting, coating and final grinding – takes 5 to 6 days for EndurAll coatings and 7 to 10 days for Endura MG coatings.

Optimal surface roughness is indispensable for consistently high tissue creping quality. EndurAll coatings are finished to an Ra value of 0.4 to 0.6  $\mu\text{m}$ , which, combined with an ideal crowning curve and optimized organic cover material, ensures improved tissue quality. Another benefit is considerably extended doctor blade life, resulting in additional cost savings.

Tissue machine re-start can be supervised by an experienced Voith engineer, who, at the same time, optimally adjusts the production parameters to suit the new roll surface characteristics. Under optimal conditions the new surface coating will not require any re-grinding for several years, thanks to its extremely high wear resistance.

Likewise MG cylinders require optimal surface roughness to attain high paper gloss and smoothness. The normal cast surface quality can be ground down to minimal Ra values of 0.1-0.2  $\mu\text{m}$ . With Endura MG coating Ra values of 0.05-0.15  $\mu\text{m}$  can be reached, thus improving paper gloss and smoothness accordingly. This hard and smooth surface coating retains consistently high Ra values over its service life, which is extremely long.

These coatings not only increase the service life of creping and MG cylinders, but also can significantly improve paper machine runnability and product quality.

#### Coatings pay off for the user, because...

Creping and MG cylinders are extremely high stressed paper machine components – on the one hand high thermal strain through internal steam pressure and drier hoods, and on the other hand mechanical strain by press rolls and doctor abrasion. The cylinder surfaces, therefore, have to be reground whenever necessary, at the same time restoring the crowning and concentricity to a tolerance of 0.02 mm. The normal grinding intervals are 12 to 24 months for creping cylinders and 10 to 20 years for MG cylinders.

The cylinders are mainly used for drying paper or board and are heated from within by steam at a pressure of up to 10 bar. They are, therefore, subject to pressure vessel regulations, i.e. they have to be officially inspected at regular intervals like an automobile. Their safety is checked thereby, both visually and based on the admissible loading characteristics. The diagram, which indicates the Maximum Allowable Working Pressure (MAWP) is very important for the operational safety of the cylinder, because they directly indicate the maximum admissible steam



pressure according to wall thickness, as a function of external loading (such as line force applied by the press rolls). Since the cylinder wall thickness is reduced every time it is reground, the admissible steam pressure reduces accordingly.

Cylinder wall thickness reduction is not necessarily a drawback, however, because thinner cylinder walls make for better heat transfer and improve the cylinder's drying performance. Nevertheless, there are limits to drying performance improvement by thinner cylinder walls. Voith Paper Rolls can calculate the optimal drying performance, which is generally at a wall thickness of about 3 to 4 mm more than the minimal wall thickness at which the cylinder has to be decommissioned.

Yankee dryers are delivered with a grinding allowance of 12 to 15 mm, so that they last about 30 years. Instead of replacing them with a new cylinder, they can be resurfaced to make them last much longer. Voith Paper Rolls recommends this coating procedure as soon as the optimal drying performance has been reached. Furthermore, resurfacing of Yankee dryers is also recommended if their performance is negatively affected by excessive porosity of the cast shell.

**...resurfacing saves investment costs by making Yankee dryers last much longer!**

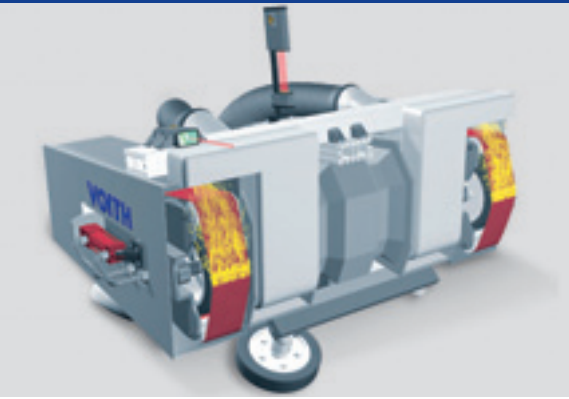

## Virtual Reference Grinding – Joseph von Fraunhofer Award 2005

**Virtual Reference Grinding (VRG) is an innovative grinding method to re-condition drying cylinders on-site and in-machine. The VRG grinding was commercially introduced in early 2005 and, to date, sixteen large Yankee dryers have been serviced in-situ.**



**Sjaak Melkert**

Rolls  
sjaak.melkert@voith.com

VRG grinding technology is unique and fundamentally different from conventional methods of roll and cylinder grinding. Grinding is not accomplished through a “geometrical-coupling” between grinder and roll or dryer, but through a “force-coupling”. Material is removed by applying grinding forces only exactly where necessary (Fig. 1).

As a consequence, the VRG grinding machine is very compact but extremely powerful, lightweight, and can be easily shipped and installed, saving considerable down-time both to service the Yankee dryer and for diagnostic purposes (Fig. 2).

*“My idea to develop a grinder on this force-coupling principle was born in 1999. At that time, the German Fraunhofer Institute was contracted to further develop this innovation into a practical technical solution.”*

The Fraunhofer Gesellschaft is the largest applied research organization in Germany operating a total of 80 research units with

a total staff of 12.500 scientists and engineers. Dr Ulrich Priber of the Fraunhofer Institute IWU in Chemnitz has spearheaded our VRG development from conception to a functional system. The excellent work of Dr Ulrich Priber and his team has not only resulted in a practical and unique machine tool, but has now also been awarded the 2005 “Joseph von Fraunhofer” prize. The Fraunhofer Prize is awarded to individual researchers or entire research groups at a Fraunhofer institute in recognition of excellent work in any field of applied research.

On October 19 2005, this 10,000 Euro prize was presented by the president of the Fraunhofer Gesellschaft, Prof. Dr Hans-Jörg Bullinger, to Dr Ulrich Priber and his team during the annual meeting of the general assembly (Fig. 3).

We at Voith are extremely proud of this outcome and congratulate Dr Ulrich Priber, his team, and the Fraunhofer Gesellschaft for their excellent work in developing our ideas into this unique system for the benefit of our customers.

**Fig. 1:** Virtual Reference Grinding (VRG).

**Fig. 2:** The VRG system.

**Fig. 3:** Dr Ulrich Priber.



## Full steam ahead! Steam technology – an important part of the drying process



**Erich Willer**

Paper Machines Graphic  
erich.willer@voith.com

The papermaking process is often marred by apparent trivialities. Undetectable at first, steam pressures start to decline and steam consumption rises, web dryness varies more and more, or condensate losses occur – slowly but surely, product quality and earnings are seriously affected. In other words, steam and condensate management can be equated to quality and cost management. To be on the safe side, keep your steam and condensate systems in optimal condition. With our comprehensive know-how, Voith Paper is your ideal partner for thoroughly optimizing every single component.

What is steam technology all about? It plays a key role in the drying process by transferring water evaporation energy to the paper. As shown in Fig. 1, steam technology plays a central role.

Steam technology begins at the shutoff valve of the steam supply line for the paper machine, and ends with the dry paper. Inbetween is a collection of diverse components and elements critical for efficient operation. Voith Paper will optimize the entire system, or can implement improvements step by step – even if it only means to replace a single steam joint and appropriate siphon, for example.

### So what exactly is involved?

The drying process in a paper machine critically influences cost-effectiveness of the entire line. Poor steam and condensate management often reduces production capacity and efficiency. And worst of all: it often goes unnoticed. Optimization

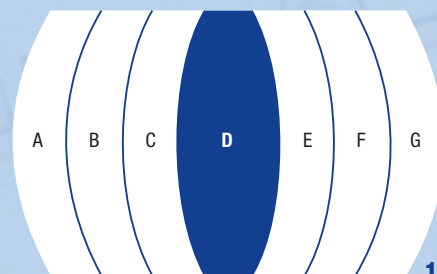

**Fig. 1:** Segments of drying technology

- A) Machine concept
- B) Clothing
- C) Web transfer
- D) Steam technology
- E) Airhandling
- F) Automation
- G) System and process maintenance.

**Figs. 2 and 3:** Key data of rotary and stationary siphons.

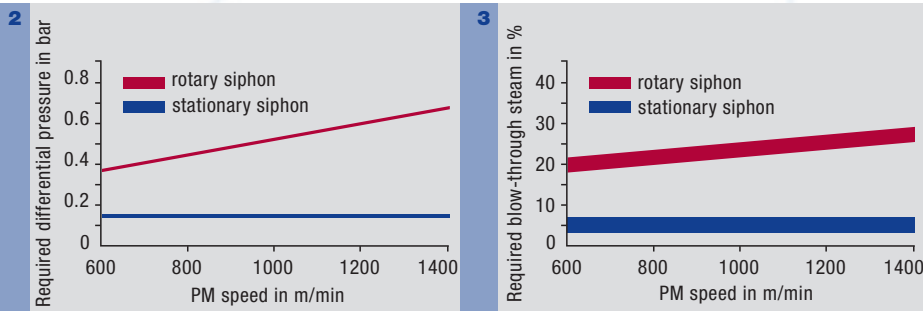

can markedly improve production and energy efficiency, and also reduce maintenance costs.

Typical deficiencies in this connection are as follows:

- Reduced operating steam pressure
- Inadequate heat transfer
- Excessive steam consumption
- Web breaks due to picking
- Non-uniform web dryness
- Dryer cylinder flooding
- Excessive steam to the heat exchanger
- Condensate losses.

### Optimization procedure

In order to identify weaknesses, bottlenecks and associated improvement potential, a comprehensive performance audit is carried out on site. This mainly focuses on the drying process, heat transfer from steam to web, drying cylinder condensate removal, and system instru-

mentation. A key role in determining improvement measures is played by the simulation of this sub-process. Thanks to years of experience, excellent compliance between simulation and actual operation is achieved. Simulation results, therefore, form a good basis for the optimization procedure.

The optimization goals derived from these findings can vary widely, such as:

- Lower steam pressures and drying cylinder temperatures after the wet end or an application system, in order to prevent web picking
- Highest possible operating pressures, in order to maximize evaporation
- Improvement of the moisture cross-profile
- Automatic drainage to avoid flooding of drying cylinders
- Lower steam consumption and condensate losses
- Lower maintenance expenses for individual components.

### Implementation

Each optimization goal has its own solution. Apart from process simulation as mentioned above, decades of experience and a comprehensive range of proven and dependable components – correctly selected according to need – assure optimization of steam and condensate systems.

Voith has supplied stationary siphons for paper dryers for more than forty years. Today, most dryer drainage projects utilize stationary siphons. The benefits – lower pressure differentials and, therefore, lower steam flows – are illustrated in **Figs. 2 and 3**. Rotary siphons are however still available for special applications.

The respective steam joints in modern design, of suitable size and type, are another indispensable element for trouble-free operation. Alternative positioning of the condensate removal, either on the drive side or the tender side, provides the possibility to control, based on systematic measures at the edge zones, the web moisture at these positions.

That is why sensitive drying systems in this connection generally have about 2/3 of the siphons on the drive side and about 1/3 on the tender side.

To improve dryer heat transfer to the web at operating speeds around 500 m/min or

more, spoiler bars inside the cylinder are very effective. They generate turbulence in the condensate film and thus reduce its insulating effect. Installed over the entire web width, they increase the overall drying capacity of the cylinder. By systematically positioning these spoiler bars at specific points over the web width, they can be used for optimizing the moisture cross-profile. They are pressed uniformly by leaf springs against the cylinder wall, and firmly held by radial retaining rings to prevent displacement due to thermal expansion differential between the bars and cylinder.

In many cases siphon and steam joint replacement also provides the possibility to install thermal insulation sleeves in the journals to optimize bearing operation conditions – after all, we believe in total optimization!

#### **Our strengths and capacities**

With five locations around the world, our staff of experts is available to assist your mill with improving the performance of your dryer section. Equipment and components are manufactured at a high-per-

formance production center with global delivery service.

A good many of our customers already take advantage of the optimization services described here, whether for medium to large paper machine rebuilds or for specific optimization in the steam technology sector alone. You are welcome to join them!

Whatever you need, your local contact partner will be pleased to help you. Or simply get in touch with one of the Voith Paper centers – you'll get our full attention!

*Enthusiastic feedback from a satisfied customer: "Carbon ring changing in no time at all – by one man alone!"*

## Paper Barring – Successful Optimization Through Systematic Analyses of all Relevant Subsystems



**Bernd Stibi**

Process Solutions  
bernd.stibi@voith.com

Paper barring denotes a frequently occurring problem in paper production, which again and again leads to damages to the production system, to production obstacles as well as to massive paper quality losses. Often such damaged board and packaging papers can no longer be further processed or sold. Voith Paper has formed a product area called „Process Solutions“, which intensively concentrates on this problem, among others. Specialists in this field analyse the problem in close cooperation with the customer and successfully work out solutions to solve it.

### What is understood by “Barring”?

Barring denotes a phenomenon that can be seen as streaking in CD direction. Generally it appears in regular spacing in a range from a few millimeters up to a number of meters.

Barring can occur in different areas and on different components of the paper machine as well as in the paper produced:

- Nip-forming rolls in press sections, size presses, calender stacks and off-line calenders may be affected (Fig. 1)
- Press felts in conventional roll presses can display barring (Fig. 2)
- The paper itself can be marked with the CD streaks known as barring (Fig. 3).

Barring on rolls and paper machine clothing leads to increased mechanical vibrations in the installed machine elements and in the building. The consequence of this unusual stress is material fatigue, which ultimately causes damages. This phenomenon occurs mostly on roll covers and press felts, and, therefore, leads to increased production line downtime and costs.

We usually speak of paper barring when streakiness is optically detectable as a variation in gloss or opacity or the homogeneity of the paper web is disturbed by particular waviness or by regularly occurring blistering (Fig. 4).

Paper barring does not only causes problems in the paper machine (e.g. increased



number of sheet breaks, deterioration of the paper profiles and the control quality) but also disturbances in the succeeding processing stages. With a correspondingly strong development of paper barring, the paper produced can no longer be used because of its poor quality and must be fed back to the internal preparation process. The barring phenomenon is particularly problematic in the paper, and the causes are generally very diverse. The causes can lay in all areas of the paper machine, the approach flow system and the building.

As a rule, visual web irregularities correlate with the profile parameters, such as basis weight, formation, ash, moisture or caliper.

Some of the mentioned profile parameters have a significant influence on the development of web drying and the associated shrinkage of the paper web. Particularly on paper and board machines for multi-layer products, this leads to a complex problem-solving situation because of the multiplication of the possible fields of causes. It is, however, important to determine the correlating parameter as exactly as possible in order to be able to narrow

down the area of causes and the transmission path into the paper web.

### Necessity and form of the applied analysis system

More complex than the recording of the problem of paper barring is the analysis of the causes that lead to streaking. In this respect, the influential factors must be, as early as possible, included in the planning of the process analysis. Only in this case the analysis will ultimately lead to the elimination of the paper barring.

An important prerequisite in the search for a solution to the problem of paper barring is, therefore, a systematic procedure in the examination of all the relevant subsystems of paper production.

The close relationship of the possible causes, therefore, requires not only the appropriate selection of the process variables to be measured but also a reasonable planning of the time sequence of the production settings to be examined. This is of major importance for a successful analysis.

**Fig. 1:** Typical development of roll barring on a press roll.

**Fig. 2:** Typical development of barring on a press felt.

**Fig. 3:** External development of barring in the paper/paperboard.

**Fig. 4:** Flatness disturbances with partially barring-like development in the paper/paperboard. Cockling = Waviness + Blistering

For a targeted and successful examination, the following formula, therefore, applies:

Time-coordinated examination and testing program + Recording of all relevant process parameters = Systematic process analysis.

### An example

In the following typical example, a cause analysis for the determination of paper barring was carried out on testliner and on other grades for further technical applications in the building industry. The analysis was done on an approx. 30-year-old paper machine with its own stock preparation system for the production of two-ply packaging paper.

The multiple modifications and optimisations of the production line carried out during the many years of operation today result in a production capacity that is far higher than twice the original capacity layout.

However, a waviness in CD direction (paper barring), visible to the naked eye,

4

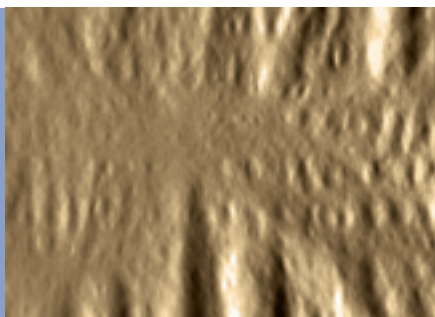

Cockling =



Waviness +

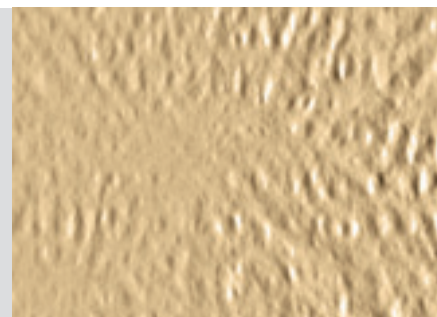

Blistering

**Fig. 5:** Typical example: Finding the cause of the paper barring complained about.

**Fig. 6:** Examination steps of the process analysis for finding the cause of „paper barring“.

**Fig. 7:** Condition measurement and analysis for determining the main influential variables on the paper barring complained about.

**Fig. 8:** Examination steps for determining concept-related bottlenecks.



impairs the high quality demands. Due to the associated, non-uniform rewetting effects, which lead to problems particularly during further processing, Voith Paper Process Solutions were commissioned to perform a fundamental analysis of the problem (Fig. 5).

The graphic shown in Fig. 6 describes the fundamental system of Voith Paper Process Solutions in the procedure for pinpointing the cause of the problem.

In close cooperation with the papermakers and the technical office of the paper mill, the actual situation was recorded. On the basis of this, a tailor-made examination program was defined. All available information were taken into account and considered in the analysis. This included:

- Description of the problems from the point of view of the producers and further processors
- Reports of analyses carried out so far and the current result of the implementation of the recommendations
- Status of modifications to the production system carried out up to now
- Status of optimisations made up to now in the mode of operation of the production line
- The mill's own production scheduling for determination of the optimal point in time for measurement analyses on site.

In the described example, an examination program was established, based on the existing insights, for the clarification of three focal points:

1. Determination of the main influential variables on the paper barring complained about, especially:

- the differentiation of back ply and top ply influence
- the effect of existing periodic pressure pulsations in the approach flow system
- the influence of the throughputs at the relatively new back ply headbox
- the influence of the well-known high gas contents.

2. Determination of concept-related bottlenecks in the

- stock preparation system
- white water system
- capacity of the cleaner system
- approach flow dilution system.

## 6 Problem determination



### Test planning



- On-site examination of the main influential variables between paper barring and production system
- Stock & paper sample analysis
- Theoretical capacity & concept analysis of stock preparation and approach flow parts



### Evaluation of test results and determination of solutions

## 7 General condition analysis

- Paper profile analysis on industrial paper and testliner production
- Gas content measurements
- Stock consistency variation measurements
- Rotational speed measurements
- Pressure pulsation measurements
- Checking of the function of the pulsation damper
- Vibration measurements

### Analysis with special test settings

- Switch off top ply
- Switch on mechanical deaeration system

## 8 System examination and theoretical concept/capacity consideration

- General process description
- Examination of the subsystems and optimisation potentials in the main stock line of the bottom ply stock preparation system
- Examination of the stock line for top ply stock preparation
- Examination of top ply approach flow system
- Examination of bottom ply approach flow system
- Examination of approach flow dilution system
- Examination of process water system
- Examination of reject & sludge treatment
- Theoretical stock and water circulation balance

3. Determination of operation-related influences, especially in the area of:
- chemical additives in the wet end.

**Figs. 7 to 9** list the established detail examinations for the mentioned focal points in detail.

The results acquired in the aforementioned typical example extend over a wide range of optimisation possibilities. Overall, they are designed to achieve maximum success in solving the problems with best economical deployment of the investment budget.

The following table (**Fig. 10**) shows an overview of the acquired results for the described typical example. The examination, however, revealed two main problems:

- The principal cause of the waviness (paper barring) was related to the back ply, including the corresponding approach flow system
- Excessive gas contents and uncontrollable stock and water throughputs are based on the faulty layout and adaptation of the cleaner system, the break tank and the headbox operating point.

The described typical example underscores the importance of the close coordination between the system user and the analysis specialists. The example of a determination of the cause and problem solution for paper barring shows the importance of the combination of specialised knowledge in the field of systems diagnostics and the detailed knowledge of the papermakers and machine engineers about the operation of the machines and systems to be examined.

**Fig. 9:** Condition analysis of operation-related influential variables with emphasis on the “wet-end chemical system”.

**Fig. 10:** Example from the optimisation recommendation matrix after the performance of extensive measurements, analyses and calculations.

**Fig. 11:** Success with solving the problem by systematic linkage of know-how.

As shown in **Fig. 11**, Voith Paper Process Solutions offers the corresponding organisational service and the necessary know-how of a system developer and supplier so that the optimum in finding and solving the problem is efficiently worked out.

**Paper mill**  
Product and system user know-how

▼

**Voith Paper**  
Process and engineering know-how

▼

**Voith Paper Process Solutions works out synergies!**

<b>9</b>	<p><b>Examination of chemical system</b></p> <ul style="list-style-type: none"> <li>● Defoamer</li> <li>● Retention agent</li> <li>● Sizing (ASA)</li> <li>● Cationic starch and surface starch</li> <li>● Fixing agent</li> <li>● Additional chemicals (used and not used)</li> </ul> <p><b>Measurement and evaluation of the cycle values</b></p> <ul style="list-style-type: none"> <li>● Stock consistencies, freenesses, retentions, air contents, fiber load, contaminants</li> </ul> <p><b>Trials with dynamic filtration system</b></p> <ul style="list-style-type: none"> <li>● Effect and improvement potential of the retention agents</li> <li>● Interaction of the chemicals used on the dewatering behaviour</li> </ul>
----------	---

<b>10</b>	<b>Central problems</b>	<b>Measures</b>	<b>Priority</b>
	<b>Bottom liner</b>		
	Gas contents	<ul style="list-style-type: none"> <li>● Installation of a cleaning system with deaeration and closure of the reject channels</li> <li>● Raising the break tank level and installing a level control</li> <li>● Relocating the mechanical deaeration pump</li> <li>● Optimisation of the defoamer dosage</li> </ul>	1
	Periodic basis weight variations	<ul style="list-style-type: none"> <li>● Stiffening of the pipe run between 1st stage HC screen and PE tank</li> </ul>	2
	CD profile optimisation	<ul style="list-style-type: none"> <li>● Adaptation of the headbox inserts to the volume flow</li> <li>● Checking of the headbox slice blade and of the drainage elements for damage</li> </ul>	3
	<b>Top liner</b>		
	Breast roll vibrations	<ul style="list-style-type: none"> <li>● Exchange of the breast roll and check for balance and run out failures</li> </ul>	2
	CD profile optimisation	<ul style="list-style-type: none"> <li>● Checking of the headbox slice blade and the drainage elements for damages</li> </ul>	3

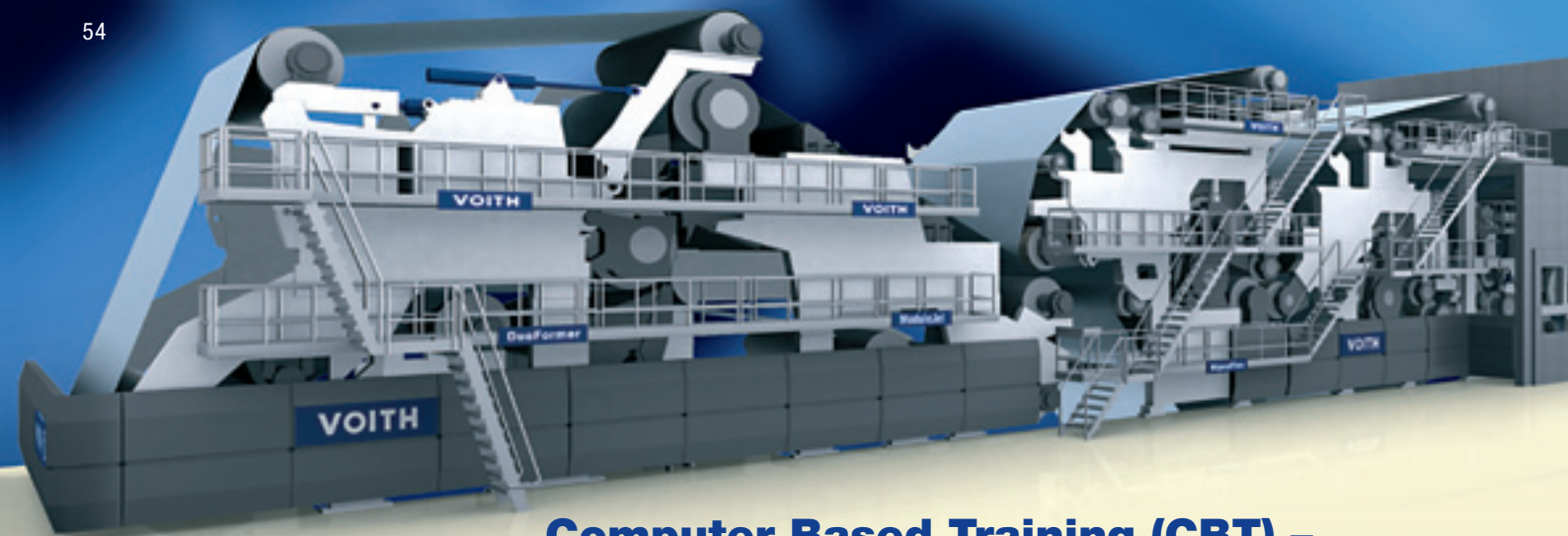

## Computer Based Training (CBT) – interactive computer based training for the pulp and paper industry

**Nowadays paper and pulp mill control rooms and production lines are equipped with cutting-edge computing technologies. These systems take over process control through pre-defined strategies. To meet market requirements and productivity goals, a full understanding of how the numerous variables involved interact is necessary. Voith has developed some very effective solutions in this connection.**



**Vicente Albiach  
Esteve**

*Voith São Paulo, Brazil  
vicente.esteve@voith.com*



**Jochen Schwalbe**

*Paper Machines Graphic  
jochen.schwalbe@voith.com*

Due to the growing complexity of automation systems in new installations and the high investments required, demands on operator training are rising accordingly. Since operators play a key role in assuring optimal production, they must undergo appropriate training on new or upgraded production lines before trial runs and commercial operation can start.

The result of this development is far greater operator responsibility for the production process. In order to avoid or minimize production faults or interruptions, and prevent fluctuations in the most important quality parameters, operators must be in the position to reliably take independent action.

This is hardly possible with conventional training methods, but computer based training enables the simulation of critical situations so that trainees immediately see the effects of their process interventions. These animated computer simulations fully comply with practice, because they are based on the same principles and programs and permit the same level of interactivity that the new systems will provide.

Conventionally, operator training in the pulp and paper industry is divided into two sections: theoretical and practical. Practical training (e.g. during the erection and commissioning phases) has proved much more effective than purely theoretic-



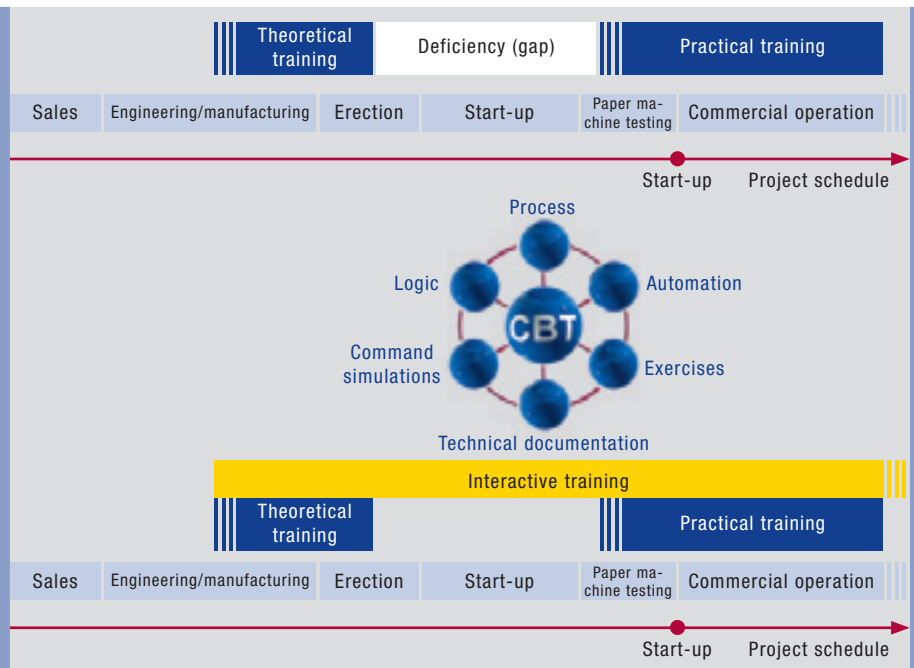

**Fig. 1:** CBT is the most effective teaching tool for virtual on-the-job training.

cal training with the same content. The best solution is obviously to combine the advantages of both methods, but without interrupting the production process. By combining the learning-by-doing approach with permanent availability, Voith has developed the interactive CBT – Computer Based Training – system. Fig. 1 shows how this innovative CBT system optimally complements conventional training from beginning to end.

Voith had long recognized the growing need for future-oriented interactive training, and developed Computer Based Training accordingly. CBT comprises animated interactive 3-D operating and maintenance training with simulation of all main processes and functions. This opens up innovative and easily understandable ways of imparting knowledge highly effectively. Voith has developed CBT as an interactive learning experience for customer personnel, with scope tailored to their specific requirements and extendable according to need. Aside from operating and maintenance instructions, CBT scope can also include for example logic diagrams, drawings, etc.

Voith Computer Based Training not only covers the entire paper production line, but also each relevant process together with logic, automation and simulation systems. It furthermore includes technical documentation together with exercises and self-examination checks. This modern



training system ensures optimal learning progress and high motivation accordingly – the best possible assurance of trouble-free production thanks to well-trained operators.

The main advantages of CBT are:

- High learn speed
- Availability of information in a structured and interactive way
- Permanent training
- Completeness and repeatability of the content
- Greater user's motivation.

Voith CBT not only enables audio-visual simulation of all kinds of processes, but also the simultaneous visualization of op-

erational and command logic sequences taking into account interlock conditions and linkages.

Supplied in digital media form (CD or DVD), Voith CBT can be used practically without limitation on all PCs in the corporate network, control room, etc.

**Process module**

The process module, including maintenance supplement, illustrates in the customer's language the technological concepts of the entire production process, including 3D animations of all machine component motions.

**Fig. 2:** Simulation of a vacuum pump integrated in the production process.

**Figs. 3 and 4:** Simulation of headbox operation in the process by calling up the nameplate data.



Mechanical maintenance procedures (fabric or roll changes, etc.) are also simulated audiovisually by 3D animations and digital mockup interactions. This enables fast and easily remembered learning of all the technological concepts and maintenance work involved in the production line.

The CBT screen in **Fig. 2** shows the simulation of a vacuum pump integrated in the production line. And **Figs. 3 and 4** show for example how headbox operation in the process is simulated by calling up the respective data on the nameplate.

### Logic module

The logic module provides simulation screens of control logic sequences and command interlocks throughout the production line. These easily understood simulations enable the automation, mechanical maintenance and production personnel to fully comprehend all the operational requirements and actions. As an

example, **Fig. 5** shows a CBT screen of the Sirius logic diagram.

### Automation

The automation module provides animated simulations of all the hydraulics and pneumatics systems together with the respective mechanical motions. The purpose and functioning of each system component is also shown.

**Fig. 6** shows a typical hydraulics system diagram for simulating motions of the headbox rear wall.

### Command simulation

The command simulation module enables operation from virtual control panels and DCS (Digital Control System) screens. All commands are automatically translated into 3D simulation of the resultant mechanical motions. This enables a complete understanding of new processes and technologies well before the actual project installation.

All the main command sequences are simulated, so that operators can fully practise corrective intervention in case of control system failure.

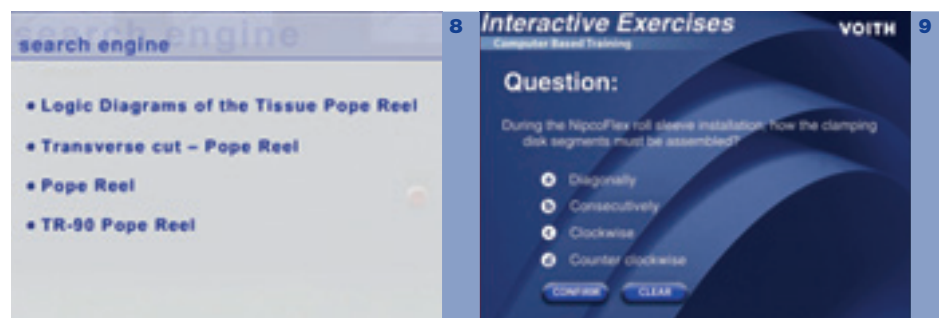

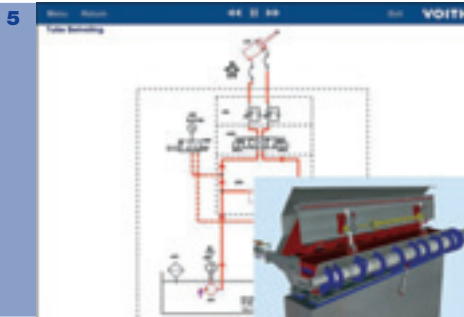
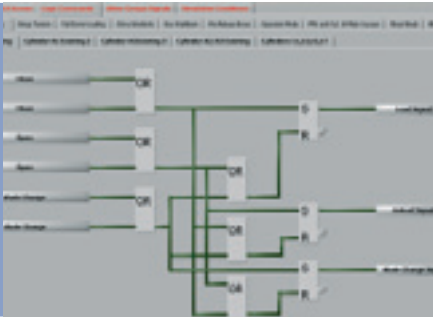

**Fig. 5:** Sirius logic diagram.

**Fig. 6:** Headbox rear wall hydraulics system simulation.

**Fig. 7:** Reel spool change and control system simulation.

**Fig. 8:** Search engine results for “Reel”.

**Figs. 9 to 12:** Interactive exercises.

Typically, Fig. 7 shows the CBT simulation screen and virtual control panel for changing reel spools.

**Technical documentation**

This module comprises a search engine for calling up all technical documentation (such as operating and maintenance manuals, drawings and diagrams, etc.) by entering a key word. Fig. 8 shows the technical documentation called up by entering “Reel” in this search engine.

**Exercises**

The exercises module enables operators to test their learning progress. In case of a wrong response or if a wrong answer is given to any of the questions asked, the respective subject matter is automatically displayed. The operator can then refresh his or her knowledge in various ways (e.g. from operating manuals, animations, etc.). Figs. 9 to 12 show a typical exercise sequence. The operator can select from multiple answers to each question. Wrong answers are indicated, and the operator is then referred to the respective documentation. After this repetition of the learning process, operators normally give the right answer.

In summary: Voith CBT offers user-friendly, self-explanatory and easily understood training in all application areas and in full compliance with customer requirements. It enables lasting and highly effective learning based on Voith Paper’s knowledge, experience and reliability.

CBT is a valuable tool for:

- maximizing production output,
- optimizing paper quality,
- and minimizing shut-down and outage times thanks to optimal operator training.

This modern training method greatly accelerates the learning progress – resulting in highly motivated personnel for troublefree operation.

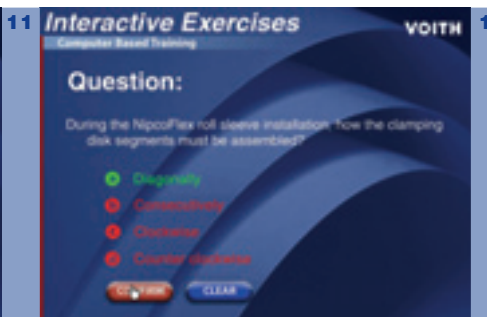
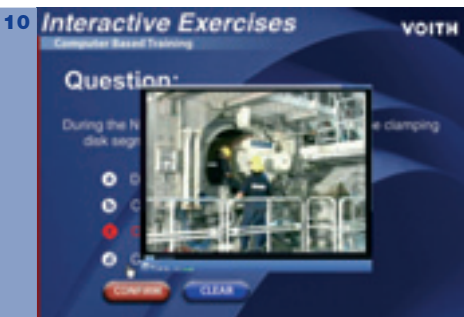
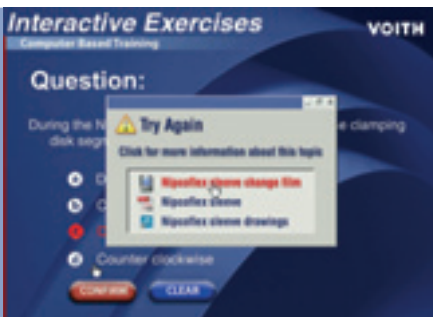



**Arved Westerkamp**

Fabrics  
arved.westerkamp@voith.com



**Matthias Höhsel**

Fabrics  
matthias.hoehsel@voith.com

## High-shaft Technology – a weaving innovation breaks new ground in forming fabric design

**The realignment of development effort at Voith Paper Fabrics has led to a new weaving technology for improving the performance of forming fabrics.**

Existing weaving technology, with no more than 26 heald frames or shafts, seriously limited the fabric weave pattern options. Voith Paper Fabrics, therefore, teamed up with a leading supplier of weaving machinery to develop a new generation in this technology.

The goal of this development effort was a new weaving concept enabling a far wider range of design options while retaining the geometrical layout of conventional weaving machines. This goal has now been attained with the new high-shaft technology, using a larger number of shafts than previously – an innovation that opens up a new era in fabric weaving technology.

No time was lost in putting this high-shaft weaving technology into practice: the new weaving machines meanwhile installed have rapidly brought their users possibilities unimaginable in the past.

Our ongoing development work on a completely new product portfolio shows up the enormous potential of this weaving innovation. Preliminary test results already verify the greatly superior performance of forming fabrics woven by high-shaft technology.

### Weaving technology

Forming fabrics are woven on a highly complex weaving machine system that determines the basic structure or design according to the way the shaft and weft threads intermesh.

The shaft threads are raised and lowered in the weaving machine by heald shafts, also known as shaft frames, according to the pattern determined by the designer. Weaving takes place by projecting inserting the weft threads through the shed opened between the upper and lower shaft threads (**Fig. 1**). The maximum num-

**Fig. 1:** Operating principle of a weaving machine.

**Fig. 2:** High-shaft weaving machine.

**Fig. 3:** Weave pattern of a 4-shaft fabric surface.

**Fig. 4:** Schematic representation of main binding diagonals.

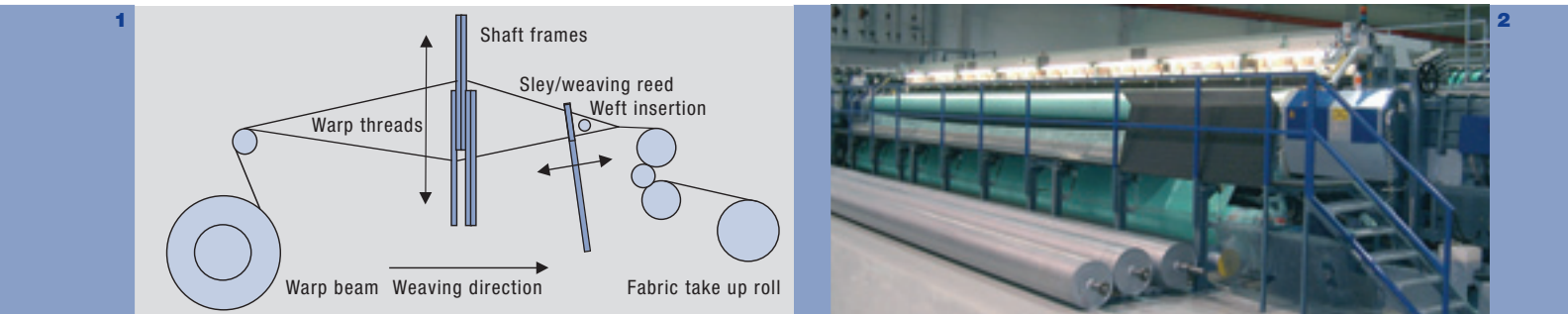

ber of weaving patterns possible basically depends on the number of shaft frames – the more shafts the more patterns. A high-shaft weaving machine is shown in Fig. 2.

### Why a new forming fabric generation is necessary

Papermakers and machine suppliers these days constantly have to meet new technological demands – whether in connection with furnish quality, new process components, or greater productivity with ever-increasing speeds and quality requirements – and these trends also affect

forming fabric manufacturers. As leading partner to the paper industry, Voith is the only supplier able to offer not only entire production lines, but also all paper machine fabrics on a customized basis.

Future demands on product quality and runnability cannot be met by conventional fabric technology, which no longer allows any significant improvements. For example, stability, drainage behaviour and freedom from marking can only be improved by completely changing the fabric weave structure. The Voith Paper Divisions paper machine and fabrics development engineers, therefore, investigated the technical possibilities for achieving this aim.

A thorough analysis of Voith Paper Fabrics and other companies' products confirmed in particular that the regularly repeated weave patterns in conventional fabrics tend to emphasize marking. The goal was, therefore, to correct this situation by developing a new weaving technology.

### High-shaft technology

Diagonal patterns are formed in all kinds of textiles by longitudinal and lateral repetitions in the basic weaving register. This is clearly illustrated in Figs. 3 and 4. Such diagonal patterns continuously interfere with drainage behaviour by creating similarly structured drainage channels at regular intervals.

In the wet section of the paper machine this results in drainage pulses being repeatedly transferred to the same points on the web, where they cause marking as a function of the natural oscillation frequency behaviour and interaction between the forming fabric and paper machine.

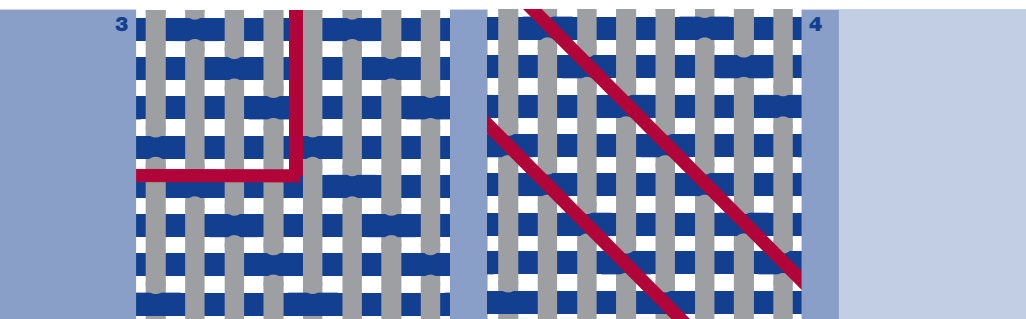

**Fig. 5:** Schematic representation of regular drainage pulses, and their overlapping (in blue).

**Fig. 6:** Schematic representation of irregular drainage pulses, and their overlapping (in blue).

**Fig. 7:** Schematic representation of regularly distributed binding points in e.g. 3-layer fabrics.

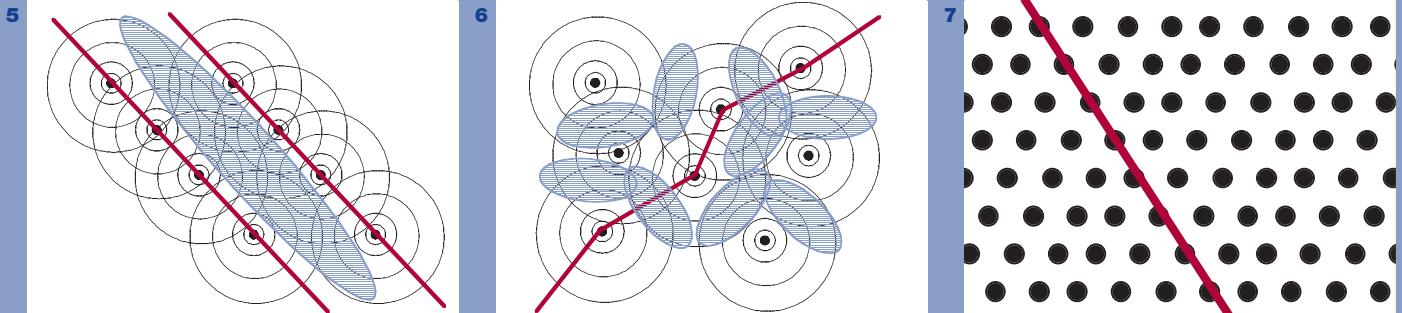

As shown in **Fig. 5**, the drainage pulses due to repetitive weaving patterns generally lead to local changes in drainage behaviour that are emphasized in the pulse overlap zones. The worst-case scenario is hydraulic marking, often with a negative effect on fillers retention as well.

The high-shaft technology developed by Voith Paper Fabrics now makes it possible to eliminate these diagonal patterns in the fabric weave either completely, or only partially if desired. This results in the effect shown in **Fig. 6**: reduction of web marking thanks to systematic interference with the drainage pulses. Since the pulse overlap zones are irregularly distributed, their effect is more diffuse and less disturbing.

According to these findings, the optimal solution would be a plain weave either without diagonals, or with diagonals in all directions equally. But unfortunately, this would only solve the marking problem.

Drainage fabrics, however, must also meet requirements for pickup volume, cross-stability, etc. For this reason widespread use is made today of fabrics with a fine-mesh plain weave on the side con-

tacting the paper web, and a coarse e.g. 5-shaft weave on the drainage and stabilizing side. This combination would theoretically produce first-class paper – except for the problem of binding the two sides together.

With first-generation 3-layer fabrics this problem was tackled with a separate binding thread system as third layer. The result however was formation faults, because to take up relative motion between the layers, the binding threads were prestressed shrunk during the heatsetting process during in fabric production and, therefore, interfered with flatness on the side contacting the paper web. Similar effects were caused at the binding thread attachment interlacing points on the other side of the fabric. Furthermore, the binding threads in first-generation fabrics were simply passed around the shaft threads on this side, so that frictional wear between the binding and shaft threads led in time to ever-increasing web marking.

The marking problem has been solved to a considerable extent by developing weft-bound 3-layer SSB (Sheet Support Binder) fabrics with binding threads that also

have a fiber support function on the side contacting the paper web. However, the problem still remains of marking due to small shaft registers.

Increasing the number of shaft frames opens up far more binding possibilities in the production of forming fabrics. These possibilities include discontinuous diagonals and almost free distribution of the binder attachment and detachment points. Fabrics produced with this high-shaft technology greatly improve the web marking situation.

The schematic distribution of binding points with regular weave register pattern in **Fig. 7** clearly shows the diagonals formed, that can be subdivided into principal and secondary diagonals (not shown).

By contrast, the irregular distribution of binding points in **Fig. 8** clearly exhibits discontinuous diagonals that are almost freely distributed.

Papermakers today are no longer limited to weft-bound SSB fabrics woven with 16, 20 or max. 24 shaft frames. Voith Paper Fabrics high-shaft technology now

**Fig. 8:** Schematic representation of irregularly distributed binding points in e.g. 3-layer fabrics.

**Fig. 9:** Comparative drainage performance of 20-shaft as against 40-shaft fabrics. Drainage performance in % of headbox volume.

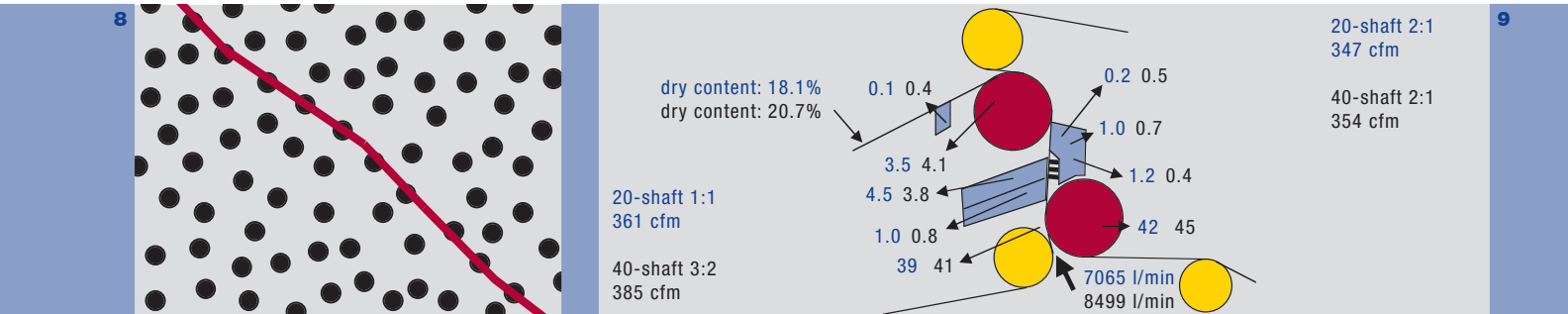

sets new benchmarks with a product range woven on 40-shaft looms. These fabrics are similarly structured to 20-shaft weft bound SSB fabrics, with a plain-weave layer on the paper web side to ensure good fibre support and a 5-shaft layer on the other side for good pick-up and cross-stability. But they have the outstanding advantage of far greater freedom in binding weft distribution, which can, therefore, be optimized without making any compromises.

### First commercial results

Before undergoing practical trials in the paper industry, testbed runs were carried out on the VPM 4 pilot paper machine in Heidenheim with a TQv former in the wet section. For comparative testing purposes, SC-A paper with 71°SR freeness and approx. 32% ash content was chosen because of our extensive experience with this grade on VPM 4, where numerous tests have been carried out on weft-bound SSB fabrics woven with fewer shaft frames.

Fig. 9 shows the TQv former drainage layout.

The drainage performance of the 20-shaft fabrics is marked in blue. The outer fabric has a weft ratio (web side/backing side) of 2:1 and an air permeability of 347 cfm, while the inner fabric has a weft ratio of 1:1 and an air permeability of 361 cfm.

The drainage performance of the 40-shaft fabrics is marked in black. The outer fabric has a weft ratio (web side/backing side) of 2:1 and an air permeability of 354 cfm, while the inner fabric has a weft ratio of 3:2 and an air permeability of 385 cfm.

The headbox volume output is controlled by flow regulation in zone 2 of the suction box, in both cases at 350 litres/min. Drainage performance is shown as a percentage of headbox flow rate [%].

Initial drainage performance of the 40-shaft fabrics is clearly higher than that of the 20-shaft set. Also in the vicinity of the suction roll, drainage performance of the 40-shaft fabrics is much higher, resulting in a significantly higher dry content of 20.7% at the pick-up instead of 18.1%. Commercial production results confirm these test findings.

### Summary

A retrospective examination of product developments in forming fabric technology over the last ten years shows that these have been more of an evolutionary nature than revolutionary.

The high-shaft technology developed by Voith offers our partners in the paper industry the benefits of a genuine innovation that brings significant improvements compared with existing standards.

Thanks to systematic development investments opening up new possibilities in forming fabric design, Voith has once again set an important benchmark in the ongoing improvement of paper quality.

The first commercial results with high-shaft technology fabrics on paper machines are extremely promising, and the potential for further developments with this technology is very high exceptional. We are therefore focusing our full development effort in this sector on new future-oriented product generations.

## Voith Paper and IHI Strengthen the Partnership Create, Build-Up, Secure!



**Martin Schily**

Voith Paper IHI  
martin.schily@voith.ihl.co.jp

**Fig. 1:** Mr Kuwabara (President Industrial Machinery IHI), Mr Ito (President IHI), Mr Kose (President VIPT), Mr Schily (Vice President VIPT), Dr Sollinger (Chairman of the Executive Board of Voith Paper), Mr Hatagawa (Vice President Industrial Machinery IHI), after the signature of their agreement to increase Voith Paper's share in VIPT.

**Fig. 2:** The seminar room.

**Fig. 3:** The speakers during Q&A with customers. From left the speakers: Mr Tuomola (Managing Director LEIPA GmbH), Mr Burke (Senior President Voith Paper Fabrics Asia), Mr Halmschlager (Member of the Board of Management Voith Paper St. Pölten Board & Packaging), Mr Wassermann (Senior Vice President Voith Paper Graphic Papers), Mr Morita (Director VIPT), Dr Pfalzer (Executive Vice President Voith Paper Fiber Systems), Mr Münch (Executive Vice President Voith Paper Automation), Dr Sollinger (Chairman of the Executive Board of Voith Paper), Mr Kose (President VIPT).

**Fig. 4:** The "Edelweiß Group" gives a refreshing presentation of Bavarian October Fest atmosphere.

The joint venture company Voith IHI Paper Technology Co. Ltd. (VIPT) started its operations in April 2001 after more than twenty years of close cooperation between Voith AG and Ishikawajima-Harima-Heavy-Industries Co., Ltd (IHI) in the field of paper technology. When the presidents of the founding companies, Dr Sollinger from Voith Paper and Mr Ito from IHI, met in September 2005, they were both stressing their satisfaction with the successful cooperation between Voith and IHI and the good results of VIPT.

Both stressed their intention to further support a strong development of VIPT and to be a reliable partner for customers in Japan, Korea, and other South-East Asia countries. Following through on the good results, Voith Paper and IHI also concluded an agreement to increase Voith Paper's share, showing the commitment to the industrial leadership of Voith Paper.

Following this important event for VIPT, confirming that Voith and IHI strengthened their ties in VIPT, an even more exciting event for the Japanese paper industry took place in Tokyo: A first all-Voith Paper seminar for the Japanese Paper Industry was organized by VIPT. All divisions of Voith where invited to present a glimpse

into Voith Paper's new ideas for the future of papermaking. The invitation under the motto "Voith Innovations" raised high interest, which was apparent from the 150 participants from the customers' side. In order to make this event fruitful and efficient for all participants, all presentations and discussions were translated into Japanese simultaneously, which also contributed to the great success. Good preparation and organization guaranteed a smooth program sequence to the benefit of the participants and fostered intensive communication.

The day was filled with the presentation and discussion of only the newest developments at Voith Paper and Fabrics:





Especially the new “Paper Technology Center (PTC)” in Heidenheim and the Voith HighDryer and BoostDryer concepts have caught the interest of the participants. Mr Jaakko Tuomola, Managing Director of Leipa GmbH, presented the Leipa Schwedt PM 4 project, a production line for LWC papers, supplied by Voith Paper, that started up in mid 2004. The details were received with high interest. The feedback of customers at this seminar has been broadly very positive.

Another high point of the meeting was the party with customers, arranged by Voith IHI Paper Technology, in view of the “German year in Japan”. It was celebrated just at the same time and further deepened the friendship and cooperation between Japan and Germany.

Not only the invited customers, but also members of the German Culture and Industry Society, participated at the final event of the seminar. The seminar has also been honored by the visit of many of the top management of the industry and by Mr Stefan Gallon, the Ambassador for Economic Issues of the German Embassy, and the top management of Voith Paper and IHI. In order to respect the long ways home of the participating persons, this event was arranged to be short, but impressive. And judging by the comments of many of the participants, this seminar was a full success.



## Right on the customer's doorstep – Voith Paper Technology Days



**Markus Wild**

*Paper Machines Graphic  
markus.wild@voith.com*

**Customer congresses, trade fairs and symposia mainly serve for drawing the widest possible attention to product developments, and for fostering contacts whether old or new. However, such large-scale events often leave out some important aspects due to sheer lack of time.**

Voith Paper has solved this problem by organizing so-called Paper Technology Days in parallel to the main event. These conferences focus on a specific country or customer segment, and are tailored to the needs of participants. Usually they only deal with one main theme of particular interest to those attending. Voith Paper Technology Days are now so popular that they have become practically indispensable to our customers.

At the end of 2005 our Technology Days were held under the auspices of Voith Paper Asia in India, Thailand and Indonesia. We invited the graphic paper producers in those countries to conferences on the theme of “Small paper machine rebuilds: big returns for a small investment”. Examples were shown of how typical production bottlenecks, such as unfavourable basis weight cross-profiles, can be overcome thereby. Topical problem

These events are organized on a supralocal and interdivisional basis in teamwork with local Voith representations, thus enabling perfect coverage of the agenda.



*Bangkok*



*Chennai*



areas were discussed at length, and it was explained how small rebuilds using the latest technology can bring astonishing improvements in such cases. Rebuilds@Voith, an independent Voith expert group free of other tasks, is currently concentrating exclusively on rebuild measures in the paper industry. In many cases even the smallest rebuild elements in the Voith AMB (After Market Business) range have a surprisingly positive effect.

Our two Paper Technology Days in Thailand started on November 23, 2005 in Bangkok, where we hosted 85 delegates of the Siam Group. Thanks to the support of C.L. International, the local Voith Paper representative, we were able to set the perfect scene for ensuring a successful kick-off day, which was fittingly concluded with a gala dinner and a lively discussion round. The second Technology Day in Thailand was held at Advance Agro in Pratchinburi, where, once again, our selected agenda suited the target group so well that a lively round of detailed discussions ensued.

In India our two Technology Days were held in Chennai and Delhi, thus serving regional customers in the south and north of this large country. According to feedback from participants, their expectations were exceeded, not least thanks to excellent support by the Voith Paper India people. About 140 specialists from the Indian paper industry familiarized themselves here with Voith's rebuild know-how, and discussed practice-oriented examples at length.

Motivated by the success of these events in Thailand and India, we completed our Technology Days tour in Jakarta, Indonesia. Thanks to first-class planning and support by Voith Paper Jakarta and the

local Voith Paper Rolls Division team, this final event of the series was an occasion to be remembered.

The particularly positive response to our presentations on "Headbox rebuilds to dilution water technology" and "The single NipcoFlex press" once again confirmed that we had chosen the right rebuild themes for this customer group.

Together with the thanks we received from numerous participants, analysis of the feedback forms from our nearly 400 guests impressively documents the outstanding success of these events. The requests we have received for more of these Technology Days, dealing with various other themes, clearly demonstrate the thirst for know-how among our customers in the paper industry. Voith Paper takes this as confirmation that we are on the right track in expanding the Technology Days concept.



Jakarta



Delhi





1

## Give work safety an additional chance

**Whoever works in vessels and confined spaces takes a big risk: every minute counts in an emergency and in particularly tight spaces, valuable time can be lost during rescue work. Every entry presents a hazard.**



**Herbert Kotitschke**

Paper Machines Graphic  
herbert.kotitschke@voith.com

### The ProSafe rescue shell from Voith for greater safety

Steam-heated dryers, Yankee and smoothing cylinders used to dry and smooth the paper web are pressure vessels, which are examined internally by specialists in the course of so-called internal inspections. Entry may also be necessary to conduct maintenance or rebuilding work.

As for all work in confined spaces or vessels, this work is classified as hazardous and requires special safety measures. These also include emergency measures, comprising the rescue of injured or incapacitated persons from the interior of

these vessels. However, rescue is very difficult due to the structurally necessary, small oval access opening and is almost impossible without special aids.

Specific accident prevention regulations and guidelines, therefore, apply in these cases. Employers are required to “ensure rapid rescue” and to “provide suitable equipment” for this purpose. The protection of your employees should be among your top priorities.

The new ProSafe rescue shell developed especially for use in particularly confined conditions should not be missing from any emergency equipment. It allows accident victims to be rescued and transported away fast – even through narrow entries and over steep ladders and stairs. More than 60 rescue shells were delivered within just a short period. The clientele includes individual companies and domestic and foreign facilities of large corporations. You will find further information at [www.prosafe.voithpaper.com](http://www.prosafe.voithpaper.com)

**Fig. 1:** ProSafe.

**Figs. 2 and 3:** Rescue from a cylinder.

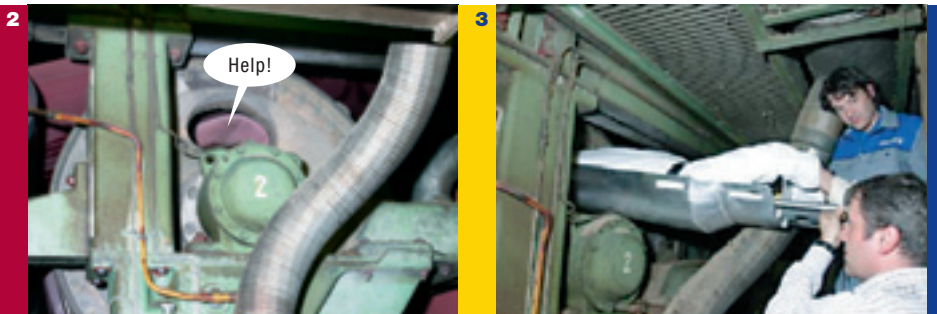



Lithograph "The 'good' press"  
from 1847 with accompanying poem:  
"Sweet censorship, please be our guide  
For on our own, we can't decide.  
We long to be under your wing  
Like children on a leading string."

## "Black on White" – 400 Years of Newspapers

Although the exact publication date of the first newspaper cannot be established, the development of what was for centuries our most important information medium, as well as the long and difficult struggle to attain freedom of the press, are documented in the remarkable exhibition "400 Years of Newspapers – A Medium Makes History" in the Gutenberg Museum in Mainz.



"Relation", the first weekly newspaper to appear regularly in the German-speaking world.

The newspaper had many predecessors, although admittedly not in printed form. Julius Caesar made a fortune as a publisher of the *Acta Diurna* ("Daily Events"), in which he fulfilled the desire of plebeians, the common people of ancient Rome, for vivid accounts of splendid weddings, scandalous trials and violent gladiator fights.

It is indisputable that the printed newspaper originated in the German-speaking world and that its emergence would have been impossible without Gutenberg's invention of the printing press with moveable type. The first newspapers that fea-

tured a range of different news topics, albeit with irregular publication dates, were issued in the 16th century, spreading from Mainz along the river Rhine across the first printing and publishing houses in Basle, Strasbourg, Cologne and the centres of trade in the Netherlands. The German word for newspaper, "Zeitung", and the later designation "Times", both trace back to the Low German word "Tiden" for the ebb and flow of the tides.

Relation, which has been proven to be the first weekly newspaper to appear regularly, was published in 1606 in Strasbourg –

it was only four pages long, but was issued punctually and at regular intervals; it did not take the form of a pamphlet on one single subject, but contained different news items that were of general interest to the extremely limited number of people who were able to read at that time. The first daily newspaper was printed about fifty years later in Leipzig, Germany. The question of whether the “newspapers” that were published earlier deserve that name remains disputed amongst experts, as these precursors lack two basic features that are considered to be the defining characteristics of a newspaper: regular publication and varied content.

The first newspaper proprietors were printers. They invented periodicals in order to be able to use their equipment and skills to secure a regular income. They collected news from different, often rather dubious, sources. And when there was not quite enough material available for the next issue, they embellished, expanded or simply made up the information. As a result, canards are as old as the newspaper itself.

Members of the large Fugger trading family, which even at that time operated internationally, took exception to the often unreliable information. They founded their own weekly paper, and, making use of their offices across Europe, established the first network of professional newspaper correspondents. They had the job of delivering short, factual and reliable news by set deadlines. For that, they received a regular “writers’ fee” of 26 guilders per year. At the time, this was a handsome fee – today, it would have the purchasing power of about four thousand euros. The Fuggers’ Hauspostille is considered to be the world’s first economic journal.

In the early stages, ecclesiastical and secular leaders did not concern themselves particularly with the content of the first newspapers and their precursors. Nevertheless, it is true that censorship (the word is derived from the Latin “censura”, the monitoring of moral maturity and behaviour) had existed since well before the invention of the printing press. The church in particular had always wielded strong influence, with the aim of

protecting the “pure doctrine”. Legend has it that in Basle and Strasbourg, there were printer’s apprentices who were burned at the stake because of their “heretical activities,” even though the poor lads were guilty of nothing more than a lack of familiarity with the Latin language – they had caused a few misprints while composing Bible texts, thus altering their meaning.

Secular sovereigns at first underestimated the power of the printed word. However, when pamphlets and newspapers went beyond simply reporting facts and started to comment on events and criticise the status quo, when publishers even went so far as to add illustrations to the written texts in order to increase their circulation and when clever wood-block and copper engravers discovered the medium of caricature, secular authorities joined ranks with the ecclesiastical leaders and censorship was legally institutionalised. The fight for “freedom of the press” had begun.

It has had many victims, many of whom remain unknown. The few whose names



Current events



Children's comics



Horoscopes



The latest fashion

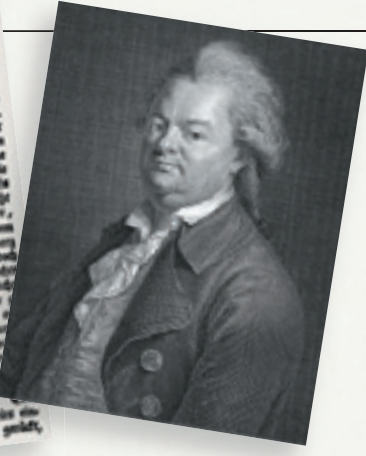

*Christian Friedrich Daniel Schubart (1739-1791) and his Deutsche Chronik, the publication of which resulted in ten years in prison.*

have been passed down from early newspaper history are not remembered as failures. Their courage to stand up for freedom of expression, even in the face of personal threat, ultimately bore fruit. Christian Friedrich Daniel Schubart, a Swabian poet, musician and journalist, is considered to be one of the great newspaper men in the newspaper's state of origin as well as in the history of the German press. His fate and that of others like him finally led to freedom of the press in Germany in the late 18th century.

Schubart was born in 1739 and grew up in Aalen near Heidenheim, now the location of the Voith company headquarters. He made a name for himself as an organist and head of the court capella. In addition, he wrote lyrical poems, including the famous one about a "capricious trout", which was later set to music by Schubert. He wrote powerful and irreverent articles for the press in which he spoke out against the powers of the sovereigns and the authority of the church. For that, he was forced to leave office and was expelled from the country. In 1774 he

founded the Deutsche Chronik in the more liberal Augsburg. The publication became one of the leading voices of German Enlightenment. Schubart's biting, polemical style became increasingly popular, much to the chagrin of the absolutistic rulers. In 1777, Duke Carl Eugen von Württemberg had him lured into his duchy and kidnapped. Schubart was imprisoned without a trial or sentence in the infamous Hohenasperg fortress, where he remained for ten years. It was not until 1787 that he was freed, thanks to the intervention of the Prussian king Frederick II. Although he tried to resume his journalistic career with a newspaper called Vaterlands-Chronik, he died in 1791, mentally and spiritually crushed. Friedrich Schiller paid a lasting tribute to his friend Schubart in his work Die Räuber (The Robbers), in which the demand for freedom of thought is made.

In 1770, censorship of any kind was made illegal for the first time for the local, German-language press in Altona, which at that time was part of Denmark. The newspapers in nearby Hamburg profited from

this as well: they were granted "a certain degree of freedom, following the English practice." The British model of a much more relaxed attitude towards the medium of the newspaper gradually became widely accepted in Germany. Hamburg developed into a significant centre of the press and has remained so to this day.

Since 1949, freedom of the press has been entrenched in Article 5 of the Constitution of the Federal Republic of Germany, as is the case in all liberal democracies. This achievement was the result of a long and arduous struggle. The history of the newspaper, free reporting and distribution in this medium, the development towards today's variety and global news transfer all mirror a high cultural tolerance. Even in the times of radio, television and the Internet, the printed newspaper remains an important pillar of democratic life. Its free, unrestrained development should be respected and protected, even though, to paraphrase Goethe, not everything that is printed black on white is worthy of being owned and read. *Manfred Schindler*



*Caricatures*



*Local news*



*Weather reports*

*The main, recurring themes of newspapers – from current events of the day right up to the weather report – are as old as the newspaper itself. As early as the first issues, publishers tried to increase the incentive to buy and hence the circulation numbers, sometimes by means of rather attention-grabbing illustrations. Only a small percentage of the population was able to read and write – the majority had to rely on literate people who read the articles out to them. The pictures served to help these listeners understand the text.*

## HIGHLIGHTS

## HIGHLIGHTS

## Startup highlights in 2004/2005

## Fiber Systems

## Stock preparation systems and sub-systems for graphic papers

Kishu Paper, Japan.  
Daio Mishima, Japan.  
Stora Enso North America, Biron, USA.  
Weyerhaeuser, Hawesville, USA.  
Blue Heron Paper, Oregon City, USA.  
UPM, Schwedt, Germany.  
Steinbeis Temming Papier, Glückstadt, Germany.  
Shandong Huatai Paper, Dongying, China.  
Gold East Paper, Dagang, China.  
Hebei Norske Skog Longteng Paper, Zhaoxian, China.  
Norske Skog Pan Asia Paper, Cheongwon, Korea.  
UPM, Steyrermühl, Austria.  
UPM, Kaipola, Finland.  
Mondi Paper, Merebank, South Africa.  
Cartiere Burgo, Mantova, Italy.

## Stock preparation systems and sub-systems for board and packaging papers

Klabin, Angatuba, Brazil.  
Klabin, Piracicaba, Brazil.  
Eucatex, Salto, Brazil.  
Conpel Cia., Condé, Brazil.  
Smurfit-Stone, West Point, USA.  
Kartonagen Schwarzenberg, Schwarzenberg, Germany.  
Papierfabrik Fritz Peters, Gelsenkirchen, Germany.  
Les Papeteries de Champagne, Nogent-sur-Seine, France.

Papierfabrik Hamburger-Spre-  
berg, Spremberg, Germany.  
Papierfabrik Adolf Jass Schwarza,  
Schwarza, Germany.  
Papier- und Kartonfabrik Varel,  
Varel, Germany.

## Stock preparation systems and sub-systems for tissue papers

PSA, São Leopoldo, Brazil.  
CMPC Tissue, Talagante, Chile.  
Metsä Tissue, Raubach, Germany.  
Productos Familia, Medellín, Chile.

## Stock preparation systems and sub-systems for dewatering machines

Veracel Celulose, Eunápolis,  
Brazil.

## Stock preparation systems and sub-systems for speciality machines

Eucatex, Salto, Brazil.

## Paper Machines

## Graphic papers

Gold East Paper, Dagang, China.  
Holmen Paper Papelera Penin-  
sular, Peninsular, Spain.  
Mondi Paper, Merebank,  
South Africa.  
Shandong Huatai Paper, Huatai,  
China.  
CMPC – Compañía Manufacturera  
de Papeles y Cartones, Talagante,  
Chile.  
Kunshan Banknote Paper Mill,  
Kunshan, China.  
Mudanjiang Hengfeng Paper,  
Hengfeng, China.  
Productos Familia, SCA Colombia,  
Bogotá, Columbia.  
MD Papeis, Caieiras, Brazil.

## Board and packaging papers

Les Papeteries de Champagne,  
Nogent-sur-Seine, France.

## Tissue

Productos Familia, Medellín, Chile.  
CMPC Tissue, Talagante, Chile.

## Dewatering machines

Jiang Lin, China.  
Veracel Celulose Eunápolis,  
Bahia, Brazil.

## Installation and rebuilds

Klabin, Angatuba, Brazil.  
Ripasa Celulose e Papel, Cubatão,  
Brazil.  
Citroplast Indústria e Comércio de  
Papéis e Plásticos, Andradina,  
Brazil.  
CMPC Celulosa, Laja, Chile,  
Suzano Bahia Sul Papel e  
Celulose, Mucuri, Brazil.  
Orsa Celulose, Papel e  
Embalagem, Paulínia, Brazil.  
Visy Paper, Melbourne,  
Australia.  
Fanapel Fabrica Nacional de  
Papel, Colonia, Uruguay.  
Shandong Hengan Paper, Weifang,  
China.  
Vinson Indústria de Papel Arapoti,  
Arapoti, Brazil.  
Kappa Herzberger Papierfabrik,  
Herzberg, Germany.  
SCA Packaging Containerboard  
Deutschland, Aschaffenburg,  
Germany.  
Tambox CCC, Tolentino, Italy.  
Arkhangelsk Pulp and Paper Mill,  
Novodinsk, Russia.  
Tecnokarton, Mayen, Germany.  
Sappi, Cloquet, USA.  
Appleton, Roaring Springs, USA.

Bowater, Calhoun, USA.  
Cartiere Burgo, Sora, Italy.  
Cartiere Marchi, Toscolano Mill,  
Toscolano, Italy.  
Fabrica Nacional de Papel,  
Fanapel, Uruguay.  
Gebr. Lang, Ettringen,  
Germany.  
Holmen Paper, Braviken,  
Sweden.  
Hong Won Paper, Hongwon,  
Korea.  
Kimberly-Clark, Munising,  
USA.  
Lenzing Aktiengesellschaft,  
Lenzing, Austria.  
Medvode, Gorican Tovarna  
Papirja Medvode d.d., Slovakia.  
Mitsubishi Paper, Hachinohe,  
Japan.  
Mondi Business Paper Hadera,  
Hadera, Israel.  
Mondialcarta, Lucca, Italy.  
Nippon Paper, Ishinomaki, Japan.  
Norske Skog Paper Mills, Albury,  
Australia.  
Norske Skog Tasman, Kawarau,  
New Zealand.  
Oji Paper, Tomakomai, Japan.  
Radece Papir, Radece, Slovakia.  
Stora Enso, Langerbrugge,  
Belgium.  
Torraspapel, Sarria de Ter,  
Spain.

## Coating technology

August Koehler, Kehl,  
Germany.  
Adolf Jass, Schwarza,  
Germany.  
Gold East Paper, Dagang, China.  
Les Papeteries de Champagne,  
Nogent-sur-Seine, France.  
Cartiera di Germagnano,  
Germagnano, Italy.



# HIGHLIGHTS

## HIGHLIGHTS

## HIGHLIGHTS

Union Industrial Papelera, Uipsa, Spain.

Korsnäs Aktiebolag, Gävle, Sweden.

Nine Dragons, Dongguan, China.

Nine Dragons Paper Industries, Taicang City, China.

C.M.C.P., Kenitra, Morocco.

Papier- und Kartonfabrik Varel, Varel, Germany.

Gap Insaat Yatirim Ve Dis Ticaret, Yaslik, Turkmenistan.

Mudanjiang Hengfeng Paper, Hengfeng, China.

Dr. Franz Feuerstein, Traun, Austria.

Shanghai Cheng Loong (SCL), Shanghai, China.

Hong Won Paper, Seoul, Korea.

Cartiere Marchi, Villorba mill, Villorba, Italy.

Khanna Paper Mills, Khanna, India.

MD Papier, Plattling, Germany.

Mondi Paper, Merebank, South Africa.

Perlen Papier, Perlen, Switzerland.

SCA Packaging Industrierpapier, Aschaffenburg, Germany.

StoraEnso North America,

Steven Point, USA.

Zhejiang Purico Minfeng Paper, Minfeng, China.

### Winding technology

Cascades, St. Jerome, Canada.

Adolf Jass, Schwarza, Germany.

Holmen Paper Papelera

Peninsular, Peninsular, Spain.

Mondi Paper, Merebank, South Africa.

S.A. Industrias Celulosa Aragonesa, Saica, Spain.

SCA Packaging Industrierpapier, Aschaffenburg, Germany.

Shandong Huatai Paper, Huatai, China.

### Finishing

#### Janus Concept

Gold East Paper, Dagang, China (2).

#### Supercalender

Ricoh Industrie France, Wettolsheim-Colmar, France.

#### Ecosoft calender

Zhejiang Rongfeng Paper, Rongfeng, China.

Henan New Century Hengxing Paper, Suixian, China.

Nine Dragons Paper Industries, Taicang, China.

Cartiere di Guarcino, Guarcino, Italy.

#### Calenders

Mondi Paper, Merebank, South Africa.

Gold East Paper, Dagang, China.

St. Regis Paper, Darwen, Great Britain.

Tullis Russell, Glenrothes, Great Britain.

Henan New Century Hengxing Paper, Suixian, China.

Changde Heng An Paper Products,

Changde City, Hunan, China (2).

Klabin, Angatuba, Brazil.

#### Roll cutting machines

Gold East Paper, Dagang, China (2).

Holmen Paper AB, Fuenlabrada, Madrid, Spain (2).

MD Papier, Plattling, Germany.

Norske Skog, Albury, Australia.

Papresa, Renteria, Spain (2).

Les Papeteries de Champagne,

Nogent-sur-Seine, France.

Papierfabrik Adolf Jass, Schwarza, Germany.

Papier- und Kartonfabrik Varel, Varel, Germany.

Cartiere Burgo, Duino, Italy.

#### Parent reel cart

Gold East Paper, Dagang,

China (3).

Norske Skog, Albury, Australia.

#### Twister/Roll Handling

Holmen Paper AB, Fuenlabrada, Madrid, Spain.

Schoeller & Hoesch, Gernsbach, Germany.

Koehler Kehl, Kehl, Germany.

MD Papier, Plattling, Germany.

Ahlstrom Osnabrück, Osnabrück, Germany.

Torraspapel, Motril, Spain.

Sappi Lanaken, Lanaken,

Belgium.

### Automation

Bowater Halla Paper, Mokpo, South Korea.

Steinbeis Temming Papier,

Glückstadt, Germany.

Gold East Paper, Dagang,

China.

Hebei Pan Asia Longteng Paper,

Shijiazhuang, China.

Stora Enso Maxau, Maxau,

Germany.

Holmen Paper Papelera

Peninsular, Peninsular, Spain.

MD Papier, Plattling, Germany.

Shandong Huatai Paper, Huatai,

China.

Papierfabrik Hamburger

Spremberg, Spremberg, Germany.

Stora Enso Kabel, Hagen,

Germany.

Les Papeteries de Champagne,

Nogent-sur-Seine, France.

Severoslovenske celulozky a

papierne, Ruzomberok, Slovakia.

Sappi Lanaken, Lanaken,

Belgium.

Stora Enso, Hyltebruk,

Sweden.

International Paper, Courtland,

USA.

Volksbetrieb Nabereshnotshelnyn-

sky kartonnobumashni kombinat,

Naberezhnye Celny,

Russia.

Papierfabrik Fritz Peters,

Gelsenkirchen, Germany.

### Voith Fabrics

Holmen Paper, Madrid, Spain.

Adolf Jass, Schwarza,

Germany.

Kappa Herzberger,

Germany.

Celulosa Arauco y Constitucio,

Planta Nueva Aldea, PM 1+2,

Chile.

Ripasa, Celulosa e Papel America,

Limeira, Brazil.

Gold East Paper, Dagang, China.

Lee & Man, Hong Mei, China.

Nine Dragons PM 9+10,

Dongguan, China.

Shandong Huatai Paper, Huatai,

China.

Empaques Modernos de

Guadalajara, Mexico.

## HIGHLIGHTS

## HIGHLIGHTS

## Recent large orders

## HIGHL

## Fiber Systems

**Stock preparation systems and sub-systems for graphic papers**

Inpacel, Arapoti, Brazil.  
 Blue Heron Paper, Oregon City, USA.  
 Weyerhaeuser, Hawesville, USA.  
 International Paper, Eastover, USA.  
 NewPage, Escanaba, USA.  
 Bowater Newsprint, Calhoun, USA.  
 Gebr. Lang, Ettringen, Germany.  
 Guangzhou Paper, Guangzhou, China.  
 Century Pulp & Paper, Lalkua, India.  
 Shandong Huatai Paper, Dongying, China.  
 Stora Enso Sachsen, Eilenburg, Germany.  
 UPM, Schwedt, Germany.  
 UPM, Schongau, Germany.

**Stock preparation systems and sub-systems for board and packaging papers**

Orsa, Nova Campina, Brazil.  
 CMPC, Puento Alto, Chile.  
 Klabin, Angatuba, Brazil.  
 Klabin, Piracicaba, Brazil.  
 São Carlos, São Carlos, Brazil.  
 Eucatex, Salto, Brazil.  
 Smurfit-Stone, West Point, USA.  
 Greif, Riverville, USA.  
 Kiev Cardboard & Paper Mill, Obukhov, Ukraine.

Naberezhniye Chelny Cardboard Paper Plant, Chelny, Russia.  
 Kartonagen Schwarzenberg, Schwarzenberg, Germany.

**Stock preparation systems and sub-systems for tissue papers**

PSA, São Leopoldo, Brazil.  
 SCA, South Glens Falls, USA.  
 Papeles Higienicos de Mexico, Col. Cuauhtemoc, Mexico.  
 Georgia-Pacific, Rincon, USA.  
 Georgia-Pacific, Muskogee, USA.  
 Fabrica de Papel San Francisco, Mexicali, Mexico.  
 Kimberly-Clark de Mexico, Ecatepec de Morelos, Mexico.

**Stock preparation systems and sub-systems for speciality machines**

Eucatex, Salto, Brazil.

## Paper Machines

**Graphic papers**

Century Paper & Board Mills, India.  
 Minfeng Paper, China.  
 Shandong Huatai Paper, Huatai, China.  
 Shandong Sun Paper Industry Group, Yanzhou, China.

**Board and packaging papers**

Dongguan Sea Dragon Paper Industries, Dongguan, China.

**Dewatering machines**

Orion Line 1+2, Uruguay.

**Installation and rebuilds**

VPAW, Eastover, USA.  
 CMPC Santa Fé, Andritz, Chile.  
 Orsa, Brazil.  
 Klabin Correia Pinto, Brazil.  
 Inpa, Brazil.  
 Aracruz Guaiba, Brazil.  
 Klabin Angatuba, Brazil.  
 Procor, Chile.  
 Inpacel, Brazil.  
 Iguaçu São José Pinhais, Brazil.  
 Iguaçu Campos Novos, Brazil.  
 Cenibra 1+2, Brazil.  
 Cenibra 3, Brazil.  
 CMPC Tissue S.A., Talagante, Chile.  
 Mondi Packaging Dynäs, Vāja, Sweden.  
 Mazandaran Wood and Paper Industries, Iran.  
 Packages Limited, Karachi, Pakistan.  
 Kappa Badenkarton, Gernsbach/Obertsroth, Germany.  
 Mondi Packaging Frantschach, St. Gertraud, Austria.  
 Duropack Bupak Papirna, Ceske Budejovice, Czech Republic.  
 Kappa Zülpich Papier, Zülpich, Germany.  
 Klingele Papierwerke, Weener, Germany.  
 Nine Dragons Paper Industries, Taicang City, China.  
 Papierfabrik Palm, Wörth, Germany.  
 Zhuhai Hongta Renheng Paper Products, Zhuhai City, China.

Neenah Paper, Munising, USA.  
 International Paper, Eastover, USA.  
 Aracruz Cellulose, Aracruz Guaiba, Brazil.  
 Bowater, Calhoun, USA.  
 Bowater, Dolbeau, Canada.  
 Bowater, Halla, Korea.  
 Cartiere Burgo, Duino, Italy.  
 Cartiere Burgo, Sora, Italy.  
 Cartiere Marchi, Toscolano Mill, Toscolano, Italy.  
 Century Paper & Board Mills, Kasur, Pakistan.  
 Cifive, Santa Fe, Chile.  
 Coastal Papers, Rajahmundry, India.  
 Crown van Gelder Papierfabriken, Velsen, Netherlands.  
 Dresden Papier, Heidenau, Germany.  
 Gebr. Lang, Ettringen, Germany.  
 Gold Huasheng, Huasheng, China.  
 Goricane Tovarna papirja Medvode, Medvode, Slovakia.  
 Holmen Paper, Braviken, Sweden.  
 Hong Won Paper, Hongwon, Korea.  
 Istituto Poligrafico e Zecca Dello Stato, Foggia, Italy.  
 JSC, Solikamsk, Russia.  
 Kimberly-Clark, Munising, USA.  
 Lenzing Aktiengesellschaft, Lenzing, Austria.  
 MD Papier, Plattling, Germany.  
 Mitsubishi Paper, Hachinohe, Japan.  
 Mondi Business Paper Hadera, Hadera, Israel.

# HIGHLIGHTS

## HIGHLIGHTS

## HIGHLIGHTS

Mondi Paper, Ruzomberok, Slovakia.  
 Nippon Paper, Fuji, Japan.  
 Nippon Paper, Ishinomaki, Japan.  
 Nippon Paper, Iwanuma, Japan.  
 Norske Skog, Golbey, France.  
 Oji Paper, Fuji, Japan.  
 Oji Paper, Tomakomai, Japan.  
 Oji Paper, Tomioka, Japan.  
 PanAsia Paper, Jeonju, Korea.  
 Papel Aralar, Aralar, Spain.  
 Sappi Ehingen, Ehingen, Germany.  
 Sappi Maastricht, Maastricht, Netherlands.  
 ShinMooRim Paper, Jinju, Korea.  
 Stora Enso, Langerbrugge, Belgium.  
 Suzano Bahia Sul Papel e Celulose, Bahia Sul, Brazil.  
 Torraspapel, Sarria de Ter, Spain.  
 UPM-Kymmene Oyj, Kaipola, Finland.  
 UPM-Kymmene Papeteries de Docelles, Docelles, France.  
 UPM-Kymmene, Schongau, Germany.

### Coating technology

Hong Won Paper, Seoul, Korea.  
 Perlen Papier, Perlen, Switzerland.  
 MD Papier, Plattling, Germany.  
 Potlatch McGehee, Arkansas, USA.  
 Cartiera di Germagnano, Germagnano, Italy.  
 Bowater Calhoun, Calhoun, USA.  
 Stora Enso Stevens Point, Stevens Point, USA.

Cartiere Villorba, Villorba, Italy.  
 Nine Dragons, Dongguan, China.  
 Nine Dragons Paper Industries, Taicang City, China.  
 Papelera del Aralar, Aralar, Spain.  
 Cartiere Burgo, Verzuolo, Italy.  
 Shandong Chenming Paper, Shandong, China.  
 CMCP Procor, Puente Alto, Chile.  
 Mitsubishi HiTec Paper Bielefeld, Bielefeld, Germany.  
 Nine Dragons Paper Industries, Sea Dragon, China.  
 Norske Skog, Walsum, Germany.  
 Shandong Sun Paper Industry Group, Yanzhou, China.

### Winding technology

Packages Limited, Karachi, Pakistan.  
 Potlatch Corp., McGehee, USA.  
 Dongguan Sea Dragon Paper Industries, Sea Dragon, China.  
 JSC, Solikamsk, Russia.  
 MD Papier, Plattling, Germany.  
 Packages Limited, Kasur, Pakistan.  
 Papel Aralar, Aralar, Spain.  
 Sappi Ehingen, Geminus, Germany.  
 Shandong Huatai Paper, Huatai, China.  
 Shandong Sun Paper Industry Group, Yanzhou, China.  
 ShinMooRim Paper, Jinju, Korea.

### Finishing

#### Janus Concept

Perlen Papier, Perlen, Germany.  
 Papel Aralar, Amezketa, Guipúzcoa, Spain.

#### Ecosoft calender

Zhangqiu Huashi Paper, Zhangqiu, China.  
 Zhejiang Xianhe Special Paper, Quzhou, Zhejiang, China.  
 Vipap Videm Krsko, Krsko, Slovenia.  
 Holmen Paper, Fuenlabrada, Madrid, Spain.  
 Shandong Huatai Paper (PM 11), Dongying, Shandong, China.  
 Shandong Huatai Paper (PM 12), Dongying, Shandong, China.  
 Weyerhaeuser Pulp & Paperboard Division, Longview, USA.  
 Mudanjiang Hengfeng Paper, Mudanjiang, China.  
 3M Canada, Brockville, Canada.

#### NipcoFlex calender

Weyerhaeuser Pulp & Paperboard Division, Longview, USA.

#### Calenders

Norske Skog, Albury, Australia.  
 Shandong Huazhong Paper Industry, Zaozhuang, China.  
 Trois Rivières Centre Intégré en Pâtes et Papiers, Trois Rivières, Canada.

Hangzhou Tongda Paper, Fuyang, China.

#### Roll cutting machines

Cartiere del Garda, Riva del Garda, Italy.  
 Oji Paper, Fuji, Japan.  
 Shandong Huatai Paper, Dongying, China (2).  
 UPM-Kymmene Papier, Schongau, Germany.  
 Stora Enso Kabel, Kabel, Germany.

#### Parent reel cart

Shandong Huatai Paper, Dongying, China.

#### Twister/Roll Handling

Shandong Huatai Paper, Dongying, China.  
 Roto Smeets, Deventer, Netherlands.

### Voith Fabrics

Nine Dragons  
 PM 1, 2, 3, 4, 5, 6, 7, 8,  
 Dongguan & Taicang, China.  
 Ledesma, Jujuy, Argentina.  
 CMPC, Talagante, Chile.  
 PISA, Santiago, Chile.  
 SCA, Monterrey, Mexico.  
 Cascades, Memphis, TN., USA.  
 Potlatch, Las Vegas, NV., USA.

# twogether

Paper Technology Journal

Newsmagazine for the international clientele, partners and friends of Voith Paper

*"twogether" is published twice annually in German, English, Chinese, Russian and Finnish. Contributions by independent authors do not necessarily reflect the opinion of the publisher. Please address all correspondence and inquiries to the editor.*

*Published by:  
Voith Paper Holding GmbH & Co. KG*

*Editor:  
Dr. Wolfgang Möhle, Corporate Marketing  
Voith Paper Holding GmbH & Co. KG  
Tel. (+49) 0751 83 37 00  
Fax (+49) 0751 83 30 00  
Escher-Wyss-Strabe 25, D-88212 Ravensburg  
wolfgang.moehle@voith.com  
<http://www.voithpaper.com>*

*Design, layout and typesetting:  
Manfred Schindler Werbeagentur  
P.O. Box 1243, D-73402 Aalen  
[www.msw.de](http://www.msw.de)*

*Copyright 3/2006: No part of this publication may be reproduced or copied by any means whatsoever without the express permission of the editor.*

*Issue 21, March 2006.*



# VOITH

**Engineered reliability.**