

# hypower

by Voith Hydro — N° 32

## Expansion

Customized components from Voith Hydro expand Vamma power station, Norway's largest run-of-river hydropower plant

10

## Installation

Snowy 2.0 power plant stabilizes Australia's energy production

14

## Automation

Digital solutions from Voith increase efficiency and safety

20

# Intelligent Hydropower

# Editorial hypower N° 32



Climate change is a catalyst for the demand for renewable energy and is simultaneously accelerating the evolution from automated to intelligent hydropower. This is because it demands greater flexibility from plant operators in order to compensate for fluctuations in the volatile energy sources of wind and solar power – something that can only be accomplished with digital solutions. We want to shape the necessary transformation process together with our customers by combining our over 150 years of hydropower expertise with the intelligent applications we have developed from it. This issue of hypower focuses on digitization's potential and reveals how it can be tapped to increase productivity while simultaneously cutting costs – and presents products and services that are already available today and already creating real value for their users. Enjoy reading this issue – and I hope you find the articles exciting and informative!

Uwe Wehnhardt  
President & CEO, Voith Hydro



# 14

Snowy 2.0 connects two existing reservoirs to form one massive pumped-storage power plant.

## Contents

### Zoom

#### 04 Digital Insights

A new kind of turbine governor optimizes efficiency and sustainability.

### News

#### 06 Brief reports

from the world of Voith Hydro.

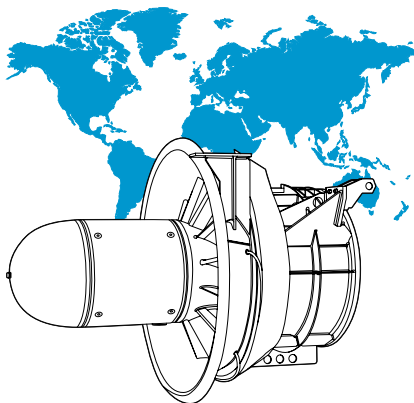

# 08

The popularity of the low-maintenance and environmentally friendly StreamDiver compact turbine is growing worldwide.

## innovate

#### 07 A Look at Key Trends

#### 08 Global Currents

The StreamDiver propeller turbine makes even small rivers and stretches of water suitable for power generation.

#### 10 Smooth Transition

Vamma, Norway's largest run-of-river power plant, has not only increased its capacity but also its flexibility with a twelfth turbine featuring customized components from Voith Hydro.

#### 14 Trendsetter for the Energy Revolution

The massive Snowy 2.0 power plant is designed to expand Australia's sustainable power generation and create a gigantic storage facility for volatile forms of energy. Variable-speed turbines from Voith play a key role.

# 36

Female engineers support each other in the "Women in Hydropower" initiative.

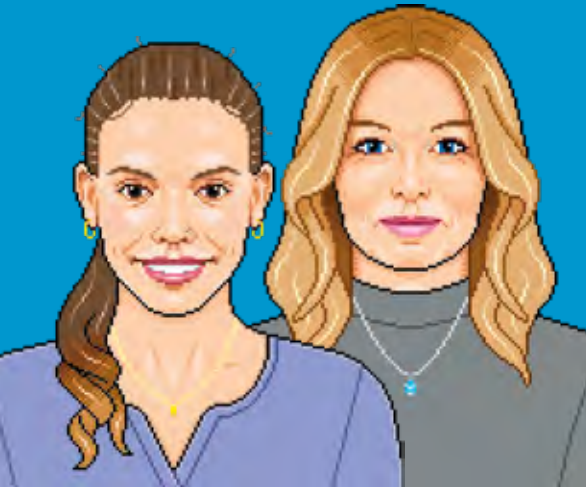

# 20

Digital maintenance strategy: Intelligent solutions optimize costs and availability.

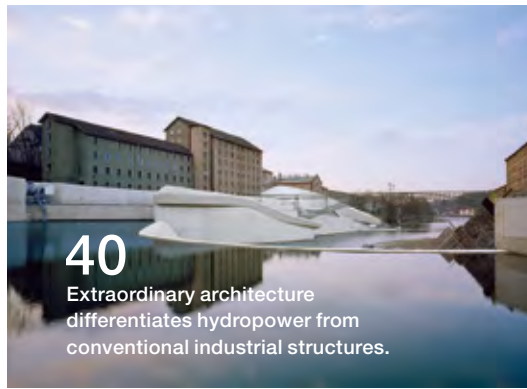

# 40

Extraordinary architecture differentiates hydropower from conventional industrial structures.

### Legal Information

**Publisher:**  
Voith GmbH & Co. KGaA  
St. Pöltener Str. 43  
89522 Heidenheim, Germany  
hypower@voith.com

**Responsible for Content:**  
Kristine Adams,  
Voith GmbH & Co. KGaA

**Editor-in-chief:**  
Gudrun Köpf,  
Voith GmbH & Co. KGaA

**Editorial work:**  
Faktor 3 AG,  
Hamburg/Berlin, Germany

**Design:**  
stapelberg&fritz gmbh,  
Stuttgart, Germany

**Printing:**  
EBERL PRINT GmbH,  
Immenstadt, Germany

**Copyright:**  
No part of this publication may be reproduced, distributed, or transmitted in any form or by any means without the prior written permission of the publisher and none of the content contained herein may be used in whole or in part in other works in any form.

Photo credits:  
Jacek Podkowinski, YouWorkForThem: Cover;  
Manfred Jarisch: p. 4–5, 33–34; s&f (Illustration):  
p. 7, 15, 18, 31; E-CO Energi: p. 10–13; Snowy  
Hydro Ltd.: p. 14–15, 18; Getty Images: p. 16–17;  
Adobe Image: p. 28–30; Bernd Schifferdecker  
(Illustration): p. 32–35; Nana Rausch (Illustration):  
p. 36–39; Brigida González: p. 41  
All other photos are from Voith.

**Your feedback:**  
If you have any questions or comments about this issue of hypower, please contact us by email at [hypower@voith.com](mailto:hypower@voith.com) or via:  
[www.twitter.com/voith\\_hydro](https://www.twitter.com/voith_hydro)  
[www.linkedin.com/company/voith-hydro](https://www.linkedin.com/company/voith-hydro)



[voith.com](http://voith.com)



## transform

19 **New Systems and Services**

20 **Intelligent Hydropower Solutions**

The digital solutions from the Voith OnCare portfolio help to individually optimize maintenance and plant operation.

28 **New Perspectives**

Nepal possesses significant hydropower potential, but with very few qualified technicians. The German Technical School wants to change that – with Voith's support.

# 32

Simon Walch, Head of Commissioning at Voith Hydro in Heidenheim, Germany, describes all of the different facets of the job of commissioning engineer.

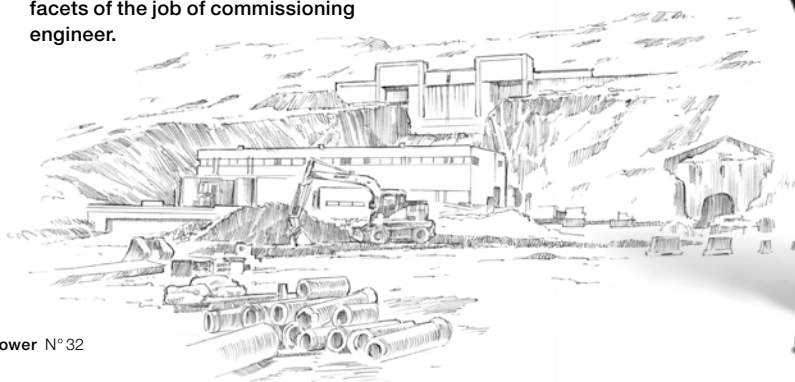

## reflect

31 **Insights and Inside Views**

32 **Adventures in Commissioning**

Implementing complex hydropower projects is fascinating and challenging. We reveal what really matters in the field.

36 **"Hy" Potentials**

A mentorship program helps qualified women enter and advance in the field of hydropower.

40 **Out of the Box**

Architecture can positively influence the public's perception of hydropower. These examples of completely different approaches from all over Europe illustrate how.







### **Intelligently Connected**

The new turbine governor is capable of simulating the entire hydraulic system and supplies data for optimization measures.

# Digital Insights

## **Compact turbine governor optimizes efficiency and sustainability**

A new turbine governor from Voith with a particularly compact design that reduces space, energy and maintenance requirements promises to increase efficiency and sustainability and unlock further optimization potential through digitalization. In doing so, the next-generation governor needs over 60% less oil than high-pressure hydraulic power units; compared to low-pressure governors, the amount of oil required drops by as much as 90%. "This solution combines state-of-the-art power electronics with reliable oil hydraulics," sums up its developer, engineer Thomas Zeller. Furthermore, it can be used to simulate the entire hydraulic system including timing, pressure and power. The collected data contains all of the information required to optimize ongoing operations. The space-saving turbine governor is scheduled to be released in 2020.

## Power Plant Expansion Supports Thailand's Energy Revolution

As part of a complex expansion project, Voith has doubled the capacity of the Lam Ta Khong (LTK) pumped-storage power plant in Thailand, located on the river of the same name some 200 kilometers northeast of the capital Bangkok. To achieve this, two additional generator sets with a capacity of 260 MW each were installed in the underground power station, increasing the total output of all four units to 1,040 MW. In addition to the pump turbines and generators, the contract also included the supply of automation solutions and the entire electromechanical BOP. Commissioning was completed in November 2019.

The expansion of Lam Ta Khong further strengthens Voith's presence in the Asian hydropower market. The project is linked to a government plan to promote and expand the use of renewable energy in Thailand. The country wants to increase its share of total power generation to 37% by 2036.

1,040  
520

Figures in megawatts

Lam Ta Khong: The expansion project doubled the plant's total capacity.

37  
12

Figures in percent

Thailand wants to increase the percentage of power generated from renewable sources from 12% to 37% by 2036.

# News

from the World of Voith Hydro

## Kössler Now Operating Under the Voith Name

The Austrian company Kössler AG has been operating under the name Voith since January 2020. This means that the company, which specializes in small-scale hydropower and has been a wholly owned subsidiary of Voith since 2008, now conducts business activities under the name of its parent company. As part of the Small Hydro division, it rounds out the division's portfolio in the range up to 15 MW.

1928

Company founded as a repair workshop for turbines and generators

2008

Company acquired by Voith as wholly owned subsidiary

Expansion of the St. Georgen site with a hydropower technology center and new production facility

2015

Continuation of Kössler activities under the Voith name

2020



p. 07 —————> 18

# innovate

A Look at Key Trends

## Digital Governor Upgrade for Ardnacrusha

When the Shannon, Ireland's mightiest river, flows from the mountains in the northwest to the coast in the southwest, its elevation only changes by 76 meters. But its importance far exceeds this insignificant drop.

The 360 kilometer river is not only an important waterway, but also a major supplier of energy for the Emerald Isle.

Since 1929, it has been powering the largest run-of-river power station in the country at Ardnacrusha.

Here the Shannon feeds three Francis turbines and one Kaplan turbine. With a combined capacity of 86 megawatts, they generate around 332 million kilowatt hours of electricity annually. To ensure that the plant continues generating power long into the future, however, a digital upgrade of the regulator technology is now underway, as the regulators from a French manufacturer installed between 1996 and 1998 are approaching the end of their technical lifetime and spare parts are no longer available. As a result, the state-owned operator Electricity Supply Board (ESB) hired Voith to modernize the plant in July 2019. The primary goal is to increase availability and prevent unplanned downtimes. "We are going to replace all of the turbines' digital governors and also modify the existing oil hydraulics," explains Wolfgang Hörger, Head of Automation Engineering, Voith Hydro.

The second element of the contract is ensuring that spare parts are always available. The first turbine is scheduled to be commissioned in June 2020. As a result, Ardnacrusha will not only be equipped with the latest governor technology, but will have a bright future for decades to come.

Generating electricity via hydropower isn't a question of scale. Aside from large reservoirs, even small rivers and stretches of water with low head have the potential to produce electricity – it's just difficult to tap. Take the United States, for example: "Of the 80,000 dams in the country, the number that generates hydropower still stands at just three percent," explains Philipp Daus, Global Product Manager Mini Hydro, Voith Hydro. Exploiting these opportunities with a cost-effective solution that is both variable and sustainable was the driving force behind the development of the Voith StreamDiver in 2011.

The compact propeller turbine can be integrated into existing infrastructure like dams, scaled to a combination of several units as required, and can even be used in environmentally sensitive settings thanks to its eco-friendly design – featuring an oil-free turbine generator set lubricated entirely by water. The design, which was deliberately kept simple, minimizes the probability of failure and doesn't require any sealing systems. This makes maintenance intervals of ten years and more possible, which reduces operating costs.

**Despite being a very young product, the StreamDiver has become extremely popular in markets around the world.**

**Philipp Daus,**  
Global Product Manager, Voith Hydro

Equipped in this way since its introduction in 2013, the StreamDiver has been able to exploit sites for power generation on a number of continents that otherwise could never have been used cost-effectively. Today, installations from Austria to Indonesia to Sweden to Brazil are proof of the efficiency of this approach. For Daus, there's no question that the turbine generator unit will continue to gain in popularity worldwide. "We're seeing a trend towards power generation from low-head waters. Even in mature markets, there's still significant untapped potential here," emphasizes the manager from Voith.



**Widely Used**

Launched in Europe in 2013, the StreamDiver has since become popular around the globe. Comparatively low costs, extreme variability, and the fact that it can be easily integrated into existing infrastructure are all reasons behind its widespread use.

Development of the StreamDiver began in 2011. The prototype was installed in Nussdorf, Austria, in 2012, and with a runner diameter of 1.3 meters, achieved a maximum output of 450 kW.

Reference	Austria Vienna	Sweden Bruksfors	Germany Heidenheim	Peru Huampani
Commissioning	2012	2015	2016	2018
Runner diameter	1,310 mm	1,155 mm	790 mm	1,310 mm
Number of turbines	1	1	1	2
Head	3.58 m	4.7 m	1.85 m	4.5 m
Rated power	314 kW	250 kW	37 kW	700 kW



Small-scale hydropower in widespread use – the flexible, low-maintenance, and environmentally friendly StreamDiver compact turbine will be generating power around the world starting in 2020. And its potential is far from exhausted.

# Global Currents



## How the StreamDiver Works

The flow of water is directed around the generator housing and swirled by the guide vanes before hitting the propeller and generating carbon-neutral power.

The StreamDiver operates completely without oil and grease-based lubricants.

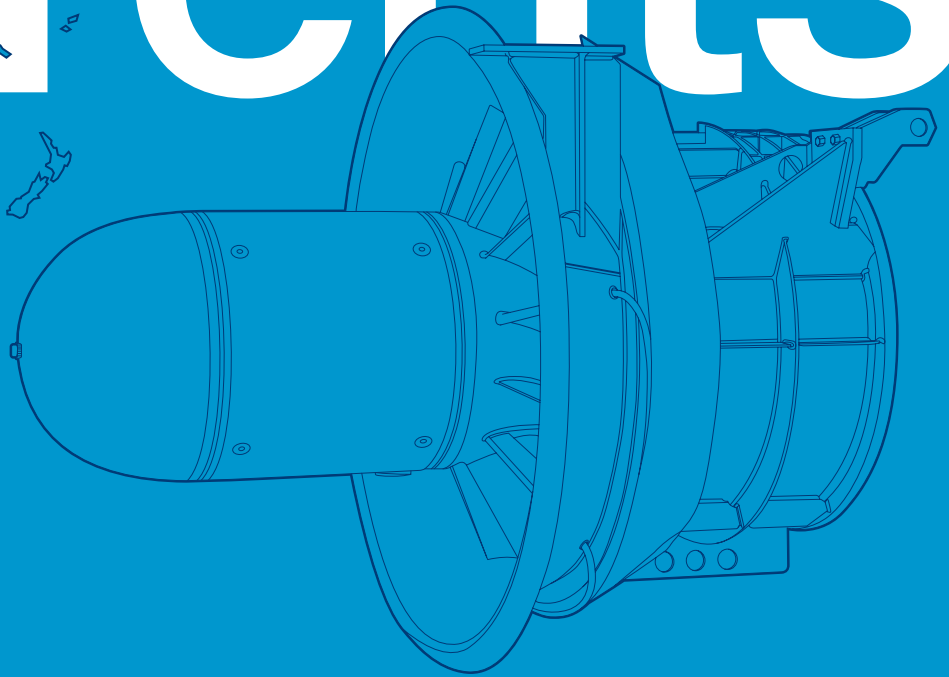

<b>Austria</b> <b>Grünau</b> 	<b>5</b> 	<b>Macedonia</b> <b>Gradište</b> 	<b>6</b> 	<b>Brazil</b> <b>Rio Chopim, Paraná</b> 	<b>7</b> 	<b>Indonesia</b> <b>Serayu, Java</b> 	<b>8</b> 	<b>Brazil</b> <b>Bela Vista</b> 	<b>9</b> 	<b>USA</b> <b>South Bend, Indiana</b> 	<b>10</b> 
<b>Lippenannerl</b>	<b>Gradište</b>	<b>Nogueira</b>	<b>Serayu</b>	<b>Bela Vista</b>	<b>South Bend</b>						
2019	2019	2020 (planned)	2020 (planned)	2020 (planned)	2020/21 (planned)						
895 mm	1,310 mm	1,310 mm	1,310 mm	1,015 mm	1,310 mm						
1	2	7	6	1	10						
4.2 m	3.73 m	7.5 m	7.57 m	8.34 m	3.17 m						
143 kW	605 kW	5,000 kW	4,500 kW	488 kW	2,500 kW						

Vamma, Norway's highest-capacity run-of-river hydropower plant, has recently grown. Within the scope of the largest new power plant project in Europe in the past 30 years, operator E-CO Energi added a twelfth turbine. It not only increases the plant's capacity and offers greater flexibility, but above all, makes it future-proof. Voith developed and installed a solution with customized hydro components.

# Smooth Transition



**1**  
**Complex Installation**  
With a runner diameter of 7.7 meters, the Kaplan turbine is the second largest in Norway.

**2**  
**Exceptional Architecture**  
When designing the power plant building, chief architect Nanna Meidell (Norconsult) worked closely with the engineers.



1

2



Norway has big plans. The country already covers 96% of its electricity needs with hydropower – but wants to go even further. “Hydropower contributes to Norway’s unique position in Europe with its low greenhouse gas emissions in the energy sector,” explains Prime Minister Erna Solberg. But to secure a sustainable energy supply for the future, many power plants will need to be upgraded, refurbished, and improved, the head of the Norwegian government makes clear. And she’s absolutely right – almost half of the country’s power generation capacity was installed before 1970 and is approaching the end of its technical lifetime.

One of these old installations is Vamma in Skiptvet (Østfold province) on the river Gomma. The country’s largest run-of-river power plant has been in operation since 1915. At the time, two horizontal Francis turbines with twin runners generated electricity – eight more were added through 1944. Generator number 11 (with a Kaplan turbine) was brought into service in 1971.

Now, almost half a century later, Vamma is taking a major step towards the future – with Voith’s help. The company developed, built, and installed the twelfth generator on behalf of the plant’s operator, the Norwegian power company E-CO Energi. In addition to the Kaplan turbine (129 MW) with a five-blade runner, the generator (150 MVA), and the governor, Voith also supplied the automation technology and the oil pressure system.

**Through Vamma 12,  
we’ve laid the  
foundation for efficient and  
socially responsible  
resource management over  
the next 100 years.**

**Finn Bjørn Ruyter**  
CEO of Hafslund E-CO

Vamma 12 was built as a completely new, independent generating unit. The dam didn’t need to be extended; however, only a separate inlet was built to connect the turbine with the reservoir used by the existing generating units.

Construction and civil engineering works began in September 2015, and the first embedded components were installed in October 2016. The main construction work began in the summer of 2018 with the installation of the turbine and generator inside the power plant building.

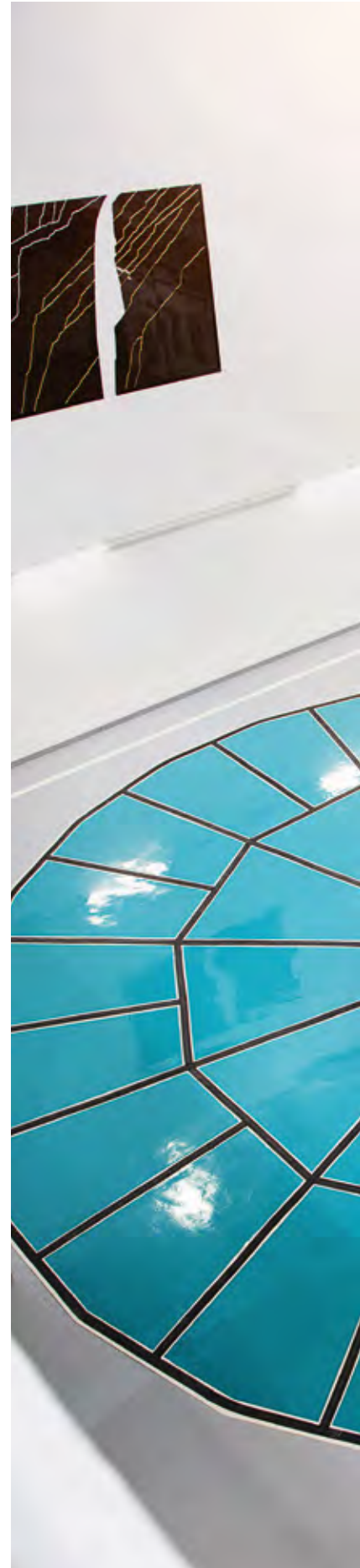



1

**High Priority**

Norway's Prime Minister Erna Solberg opened Vamma 12 in the fall of 2019. At the ceremony, she stressed the special importance of hydropower for the country.

2

**Special Status**

The new Vamma 12 building is located somewhat away from the rest of the power plant, but shares a common reservoir with the other generating units.



The control system, which processes more than 600 signals in total, was installed almost simultaneously. After extensively testing the generator during the commissioning phase, the final tests were carried out in early December 2019.

Problems with the hydraulic oil pressure system, which made it necessary to replace pumps and dismantle and clean the turbine parts, caused delays, however. "That set us back a few weeks," recalls Jon Petter Hauge, Project Engineer at E-CO Energi. "At such a late stage, it's extremely difficult to speed up the project to make up for lost time. Voith was uncompromising when it came to quality assurance and dismantled and inspected the entire oil system, including the runner and guide vane servomotors, during night shifts."



1

2



Working together closely, Voith and E-CO Energi were able to locate the cause and solve the problem. And now the system runs smoothly. “From the point of view of E-CO, we can safely say that we would select Voith again,” Hauge sums up.

The special role that the latest unit plays at E-CO Energi is already clear from the outside. Due to the building’s unconventional architecture, Vamma 12 stands out visibly from the older part of the power plant – but above all, it increases its capacity and flexibility. In terms of power output, the Kaplan turbine is the most powerful turbine ever installed in Norway and, with a runner diameter of 7.7 meters, the second largest. The runner ring made of martensitic steel was cast instead of welded – a first for a turbine of this size. “This makes it possible to produce thicker walls with cast-on reinforcement ribs, which results in a very strong design and therefore allows the turbine to run more smoothly,” explains Project Manager Robert Gruber, Voith Hydro. To achieve a high level of hydraulic efficiency, 32 guide vanes were installed instead of the usual 24 vanes. They ensure a more even flow of water to the turbine runner.

To avoid the usual coupling and run-out problems, a continuous turbine shaft with the record-breaking length of 11.6 meters was used instead of separate turbine and intermediate shafts. “This decision proved to be absolutely right during installation,” confirms Gruber. “This allowed us to greatly reduce the time required to install the shaft and we measured perfect concentricity values

# 2015–2019

**Project Duration**  
Development of Vamma 12 began in 2015. The power plant was commissioned in May 2019 and officially opened in September. The final tests were completed in December 2019.

# 1

One **Kaplan turbine** with special features: It is designed with five blades and its runner has an extremely small hub to achieve greater hydraulic efficiency.

# 28.5

A head of **28.5 meters** is used for power generation. The hydropower station is located exactly where the edge of the Vammafossen waterfall used to be.

# 1,580

Vamma will now produce a total of **1,580 gigawatt hours** per year, an increase of over 17%.

at the bearing points during the inspection.” The design effort and the optimized compatibility of the components specific to Vamma 12 paid off. “The unit achieves an unparalleled level of efficiency,” the expert sums up.

Equipped in this way, the new Vamma unit will increase power generated by the plant from an average of 1,350 GWh to 1,580 GWh per year. The increase of 230 GWh corresponds to the annual electricity demand of 11,500 apartments. At the same time, Vamma 12 also creates the breathing room needed to modernize the older turbines. This is because in many situations, only the new unit needs to be activated – at flow rates of 400 to 500 m<sup>3</sup>/s, it can generate all of the power on its own. E-CO Energi only activates additional turbines as required when the flow rate exceeds this level. At about 1,500 m<sup>3</sup>/s, all twelve units finally run at full capacity. If the Gomma river flows even faster, the flood gates are opened. “The new turbine gives us greater flexibility to make upgrades and adjustments to other turbines, which extends their service life,” says Alf Inge Berget, Managing Director of E-CO Energi. The climate changing toward more precipitation and milder, wetter years was also an important factor in the decision to increase capacity.

**The new turbine gives us greater flexibility to make upgrades and adjustments to other turbines, which extends their service life.**

**Alf Inge Berget**  
CEO of E-CO Energi

For Hafslund E-CO CEO Finn Bjørn Ruyter, there’s no question that the investment in Vamma 12 will pay off – both for his company and for Norway as a whole. “We believe that hydropower will become increasingly important in the context of the energy revolution,” the executive is convinced. “The Vammafossen waterfall has been used to generate electricity for the past 100 years, and with Vamma 12, we’ve laid the foundation for efficient and socially responsible resource management over the next 100 years.”

# Trendsetter for the Energy Revolution

The construction of Snowy 2.0 in Australia is not only going to create one of the world's largest pumped-storage power plants as the megaproject will also increase the share of power generated from sustainable sources in its energy mix and create a huge storage facility for volatile wind and solar energy.

In this context, the variable-speed turbines that Voith is supplying as part of the electrical and mechanical equipment play a key role.

Paving the way for an entire continent to completely cover all of its electricity needs from renewable energy sources for generations to come – it's hard to imagine a more ambitious goal, even in the hydropower industry. But this is exactly what Snowy Hydro Limited is looking to achieve. The Australian power company headquartered in Cooma (in the state of New South Wales) is massively expanding its infrastructure to build Snowy 2.0, which will be one of the world's largest pumped-storage power plants. In doing so, the



The Snowy Mountains, the highest mountain range in Australia, are located in the state of New South Wales. Numerous reservoirs there form the basis for generating electricity from hydropower.

focus isn't only on power generation with a total capacity of 2,000 megawatts, but also on securing Australia's energy supply, which will increasingly rely on renewable energy sources in the future. This is why Managing Director and CEO Paul Broad views Snowy 2.0 as an expansion project of national importance. "Snowy Hydro, supercharged by Snowy 2.0, will underpin Australia's renewable energy future and keep the lights on for generations to come," the executive explains.

And Voith is playing a critical role. As part of a consortium, the technology company was awarded a major contract to supply the electrical and mechanical components for the Snowy 2.0 project. This includes six pump turbines with a nameplate capacity of 333 megawatts each, three of them with variable speed. Voith is also supplying six motor-generators, the auxiliary systems, and the entire power plant automation system. In a bidding process that lasted almost two years, the company was ultimately able to secure the contract as a result of its pumped-storage expertise. "Voith is extremely proud to be part of this exciting and important hydropower project and to contribute to the further expansion of renewable energy in Australia," says Uwe Wehnhardt, CEO of Voith Hydro.



#### Energy Storage

Snowy 2.0 is designed to store enough energy to supply three million households with electricity for a week.



#### Pump Turbines

The six reversible pump turbines had to be designed for the considerable head of 720 meters.

Snowy Hydro currently operates nine power plants in the Snowy Mountains. At full capacity, Snowy 2.0 will add 2,000 megawatts of energy generation.

100 %  
2,000 MW

The plan involves linking the two existing Snowy Scheme dams, Talbingo and the higher-lying Tantangara, via underground tunnels. In an underground power station located almost 1,000 meters deep in the rock between the two dams, six reversible pump turbines will then either generate power from the water falling through them from the Tantangara Reservoir or pump it back up into the Tantangara Reservoir from the Talbingo after generating power. The power required for pump operation will be supplied by wind turbines, for example, for which there is no overnight demand. This means that Snowy 2.0 will become a huge reservoir with an energy storage capacity of up to 175 hours, which is more reliably available than wind or solar power and helps to prevent supply bottlenecks. The power plant can quickly provide additional capacity during peak loads; if required, the electricity can be fed into the grid within 90 seconds, Snowy Hydro promises. The plant is scheduled to begin energy production in 2024.

The variable-speed pump turbines, which are each coupled to an asynchronous motor generator, play a key role in this process. In contrast to a synchronous generator, this double-fed asynchronous generator's mechanical speed of rotation isn't tied to the grid frequency. Decoupled in this way, it can quickly be adapted to the respective operating conditions. This makes the pump turbines more flexible. "On the one hand, they are infinitely variable in pump mode and can therefore better compensate for voltage and frequency fluctuations in the grid, and on the other hand, they can be used to stabilize the grid frequency due to their shorter reaction times," explains Bernd Mayr, Head of Hydraulic Development, Voith Hydro.



#### Enlightening

The additional energy produced by Snowy 2.0 is enough to power 200 million LEDs at the same time.

## The Snowy Mountains Scheme Talbingo ↔ Tantangara

- 1 Talbingo Reservoir
- 2 Outlet structure
- 3 Tailwater tunnel
- 4 Tailwater surge chamber
- 5 Underground power house
- 6 Pressure shaft
- 7 Cable shaft
- 8 Surge tank
- 9 Headwater tunnel
- 10 Intake structure
- 11 Tantangara Reservoir

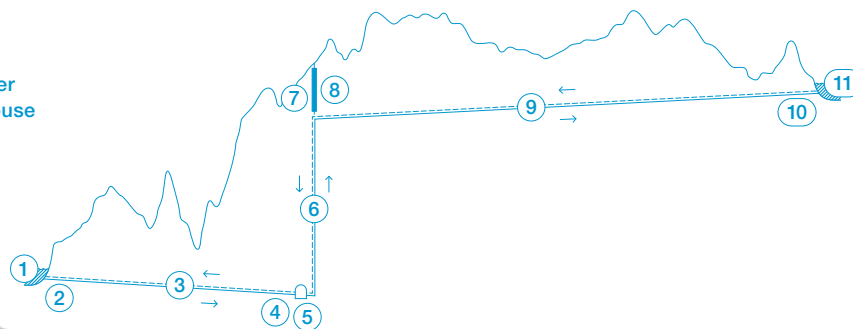

## 2024

#### Start Date

Once all of the work has been completed, Snowy 2.0 is scheduled to feed electricity into the grid for the first time at the end of 2024.



The technology has already been demonstrating its capabilities at the Frades II pumped-storage power plant in Portugal since April 2017. For the Snowy 2.0 project, however, Voith implemented project-specific enhancements in order to achieve a wider performance spectrum. “We have achieved a much wider control range than with Frades II,” Mayr emphasizes. Martin Giese, Senior Expert Pump Turbines, Voith Hydro, adds that the fact that variable-speed and fixed-speed turbines are designed for different requirements needing to be taken into account right from the design stage: “The main difference is the wide, stable, cavitation-free operating range in pump mode, which is essential to achieve the large power control range.”

Additional differences are due to the geological conditions in Australia – while the maximum drop/head at Frades II is 436 meters, it is over 700 meters at Snowy 2.0. “This head also results in higher structural and mechanical demands,” Giese makes clear, “which must be taken into account during the design process to ensure that the individual components’ permissible stress levels aren’t exceeded.” In addition, the Talbingo and Tantangara Reservoirs are located 27 kilometers apart, meaning that the flow losses due to the long pipelines also need to be taken into account during the planning.

In addition to three variable-speed turbines, Snowy Hydro also intends to use three fixed-speed units. The power supply company is keeping open the option of exploiting the benefits of variable-speed technology at a later date, however. “One of the requirements that was stipulated when the project was awarded was that the main dimensions of the six pump turbines had to be the same. Only the hydraulic design of the runners could be different,” Mayr explains. This means that upgrading the turbines at a later date will only require replacing the runner and the motor generator. “This posed quite a challenge when it came to the hydraulic design.”

Voith was able to present a high-performance turbine to Snowy Hydro during the competitive model test that met the customer’s specifications. “But the final product will be even better than what we demoed during the pilot test,” emphasizes Giese. The model acceptance date is scheduled for the summer of 2020. —>

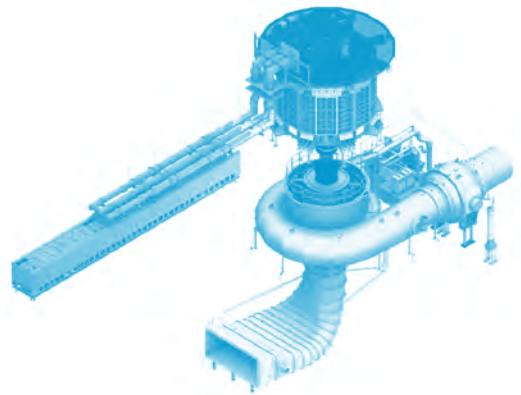

**The rotational speed of variable-speed pump turbines (pictured: a turbine from the Frades II power plant), which are connected to an asynchronous motor generator, can be decoupled from the grid frequency. This allows them to be started up at short notice and offers greater flexibility.**

# 1,000 m 27 km

The cavern for the underground power station will be excavated at a depth of around 1,000 meters. Long pipelines connect it to the Talbingo and Tantangara Reservoirs, which are located 27 kilometers apart.

To determine the magnitude of the project, one need look no further than its political significance. "I am very pleased that Voith, as the leading supplier of equipment for hydropower plants, will be supplying Australia with the necessary electrical and mechanical components for the Australian pumped-storage power plant Snowy 2.0 in the future," says the Australian ambassador to Germany, Lynette Wood. "This German-Australian collaboration has great potential and paves the way for extensive power generation from renewable energy sources – in Australia and worldwide."

**Snowy Hydro,  
supercharged by Snowy 2.0,  
will underpin Australia's  
renewable energy future and  
keep the lights on  
for generations to come.**

**Paul Broad**  
Managing Director and CEO,  
Snowy Hydro Limited

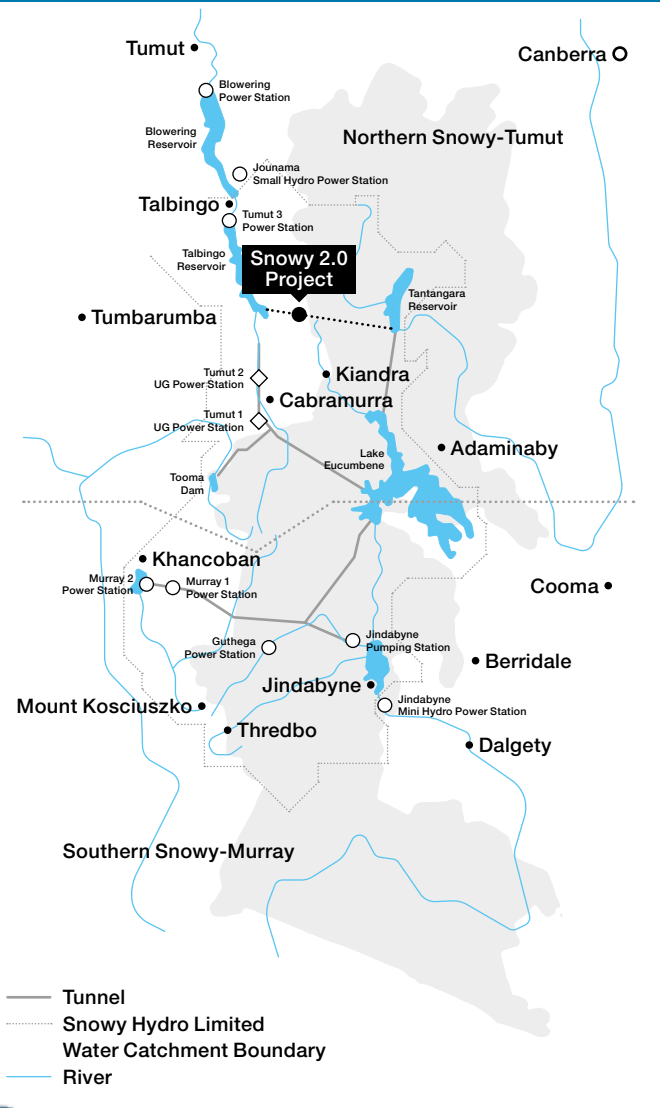

**Security**  
and flexibility are what  
EGP gains from a  
framework agreement  
with Voith for the  
modernization of turbine  
governors.

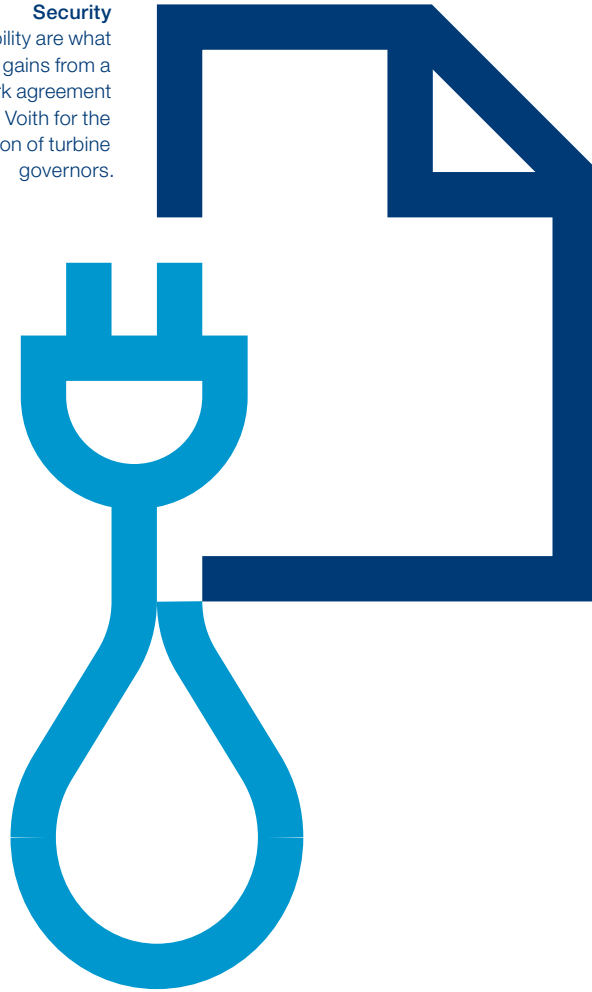

p. 19 —————> 30

# transform

**New Systems and Services**

## **Framework Agreement Allows EGP to Plan Modernization Projects with Greater Certainty**

Enel Green Power (EGP) is taking a new approach – the subsidiary of the Italian corporation specializing in renewable energy has entered into a framework agreement with Voith for the modernization of turbine governors. The agreement allows EGP to plan modernization projects with greater certainty and at the same time gives it more flexibility, as it reduces the time needed to negotiate the terms of individual projects. The framework agreement serves as the basis for establishing product specifications that apply globally. The respective EGP power plants can then adapt these to their specific needs. EGP subsidiaries in 13 countries will reap the benefits of the agreement over the next three years. EGP has chosen to work with Voith because of the company's extensive experience. Voith built the first turbine governor in 1879 and has shipped 18,000 units since then.

# Intelligent Hydropower

More efficiency and safety, less downtime – the digital tools from the Voith OnCare portfolio make it possible to develop individual solutions to intelligently optimize the maintenance and operation of hydropower plants.



# Solutions

Solutions for Safe Plant Operation  
OnCare.Health & OnCare.Acoustic

## OnCare.Availability

Continuous  
Improvement



OnCare.Asset



OnCare.Availability  
Control Interface

Consulting

$$A_t = \frac{MTBF}{MTBF + MTTR + MTTM}$$

Data Collection



Data Analysis



Reporting

MTBF = Mean time between failures  
MTTR = Mean time to repair  
MTTM = Mean time to maintain

## Reactive OnCare.Availability

OnCare.Availability empowers operators to reduce the impact of unplanned downtime. The holistic methodology identifies weaknesses in the supply of spare parts, among other issues, or specifies the required qualifications of maintenance personnel.

## OnCare.Asset



**Asset Overview with GUI**  
The clearly designed graphical user interface makes routine tasks easier. Users can create notifications without knowing the asset number and easily identify the unit they are looking for.



**Work Planning and Scheduling**  
Visualized work planning and scheduling functions allow users to make quick decisions and optimize maintenance tasks and personnel deployment.



**Flexible Use**  
OnCare.Asset can run locally on an internal server if there is no or only limited access to the Internet. Also available as a cloud-based system for customers with one or more sites.



**Performance Management**  
The application makes it possible to monitor the organization's overall performance in real time as well as track costs and downtime. Up to 20 predefined KPIs based on maintenance best practices make it easy to analyze maintenance processes.



**Mobile Application**  
All of the relevant maintenance information is available on mobile devices anytime and anywhere. Users can provide immediate feedback on the work performed.



**Materials Management**  
The application lists all of the available parts and materials and provides an overview of all of the relevant information. New parts can be reordered automatically.

## OnPerformance.Lab

Technical hydropower expert

Technical diagnostics



Energy market expert

Operation / maintenance optimization



Data scientist

Data analysis

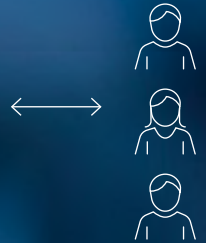

Your operations and maintenance team

# Preventive OnCare.Asset

OnCare.Asset makes efficient maintenance and repair planning possible to ensure system availability remains high while at the same time significantly reducing service and operating costs. To do so, it saves all of the documentation and system data and monitors the most important performance indicators.

# Condition-Based OnPerformance.Lab

The experts and analysis capabilities of OnPerformance.Lab help plant operators cut maintenance costs and reduce downtime through analysis and remote support. To achieve this, the experts combine hydropower expertise with state-of-the-art data analysis. The results are provided quickly with understandable suggestions and recommended measures.



by Voith

## Predictive OnPerformance.Lab

Based on the analysis of trends and patterns in plant operation, specialists use predictive maintenance to forecast the occurrence of faults in order to implement timely countermeasures through targeted service. This functionality will also be part of the OnPerformance.Lab range of services in the near future. Over the long term, Voith plans to take environmental influences such as meltwater, electricity demand and electricity price into account when determining the ideal time to carry out maintenance activities.

# Digital Tools

## Preventive Condition-Based Maintenance and Early Fault Detection with OnCare.Health

- Monitoring with highly sensitive measuring systems for effective maintenance, enhanced availability, and increased service life
- Analyses to efficiently support and optimize preventive maintenance strategies
- Diagnostic tool for condition-based monitoring to ensure safe operation at all times

## Reactive OnCare.Availability

### Reduction of Unplanned Downtimes

- Complements Voith services for power plant operators designed to cut maintenance and operating costs
- Expert help in eliminating shortcomings in spare parts management and logistics
- Analysis of maintenance employees' knowledge and skills
- Assessment of service contracts and identification of cost-saving opportunities



## Acoustic Monitoring to Detect Anomalies with OnCare.Acoustic

- Continuous monitoring of hydropower plants and auxiliary systems
- Anomaly reporting for early fault detection
- Machine learning paired with Voith Hydro expertise reduces operating risks and maintenance costs
- Easy to retrofit existing machines with the new technology

## Preventive OnCare.Asset

### Efficient Service and Maintenance Planning

- Software for planning, documenting, and monitoring maintenance processes
- All of the documentation and plant data is easily accessible in one place
- Early detection of weak points ensures high machine availability
- Reduction of maintenance costs and administrative work

## Condition-Based OnPerformance.Lab

### Digital Condition Assessment and Expert Remote Support

- In-depth analysis of power plant operating data
- Optimization of preventive maintenance strategies through condition-based decisions
- Immediate support and expert advice with specific recommended actions
- Application of industry-proven best practices

# by Voith

## Predictive OnPerformance.Lab

### Consumed Life Monitoring to Assess Plant Service Life

- 3D scans of the runners are used to create a numerical calculation model
- Assessment reveals remaining technical lifetime of the turbine
- Improved plant operation and optimized replacement/spare parts planning achieve savings

**Security**  
and flexibility are what  
EGP gains from a  
framework agreement  
with Voith for the  
modernization of turbine  
governors.

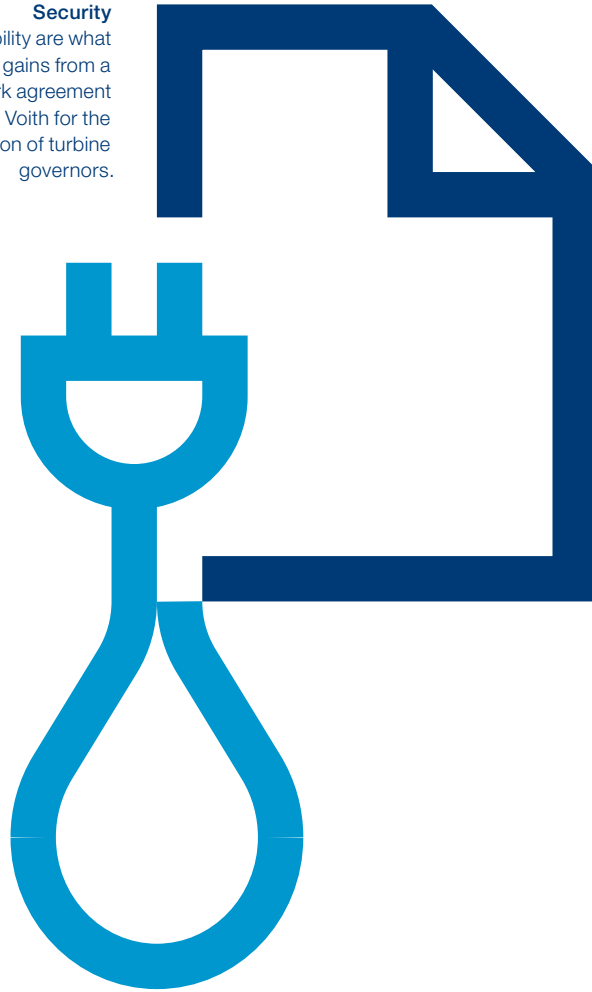

p. 19 —————> 30

# transform

**New Systems and Services**

## **Framework Agreement Allows EGP to Plan Modernization Projects with Greater Certainty**

Enel Green Power (EGP) is taking a new approach – the subsidiary of the Italian corporation specializing in renewable energy has entered into a framework agreement with Voith for the modernization of turbine governors. The agreement allows EGP to plan modernization projects with greater certainty and at the same time gives it more flexibility, as it reduces the time needed to negotiate the terms of individual projects. The framework agreement serves as the basis for establishing product specifications that apply globally. The respective EGP power plants can then adapt these to their specific needs. EGP subsidiaries in 13 countries will reap the benefits of the agreement over the next three years. EGP has chosen to work with Voith because of the company's extensive experience. Voith built the first turbine governor in 1879 and has shipped 18,000 units since then.

# Solutions

The pressure's rising. In addition to the growing demand for energy, hydropower plant operators also have to cope with the consequences of integrating renewable energy technologies into the power supply system. After all, hydropower plays a key role across the globe as a battery and buffer for sustainable power generation. It has to respond to fluctuations in grid frequency caused by volatile energy sources as quickly as it does to peaks in demand. "Due to the dynamic nature of renewable energy sources and the frequent load changes, the pressure resulting from maintenance requirements and the cost pressure are both increasing," explains Dr. Matheus Habets, Global Product Manager, Voith Hydro. "Digital solutions are the only way operators can meet these challenges."

## Digital Maintenance Strategy

The expert sees the key to this in a customized digital maintenance strategy. It is based on the existing maintenance model and supplements it with services and software solutions from the Voith range to address the operators' pain points in a targeted and simultaneous manner: "Downtimes that are too long; a lack of transparency when it comes to costs, documentation, and planning; and maintenance intervals that are too short," says Dr. Habets, counting down the list.

Two examples: If the hydropower plant operator wants to improve its reactive maintenance, the OnCare.Availability service allows it to identify weaknesses in spare parts management and eliminate bottlenecks in logistics to reduce unplanned downtimes. If the company wants to improve its preventive maintenance, the OnCare.Asset solution helps it evaluate and manage technical and digital asset data in a transparent manner. Because the software is based on the IIoT platform OnCumulus, it can also be linked to other Voith applications for hydropower. "With OnCare.Asset as an important component of intelligent, digital solutions, plant operators can cut their maintenance and repair costs by around ten percent," calculates Dr. Felix Lippold, Global Product Manager, Voith Hydro.

## Combining Hydropower Expertise with Data Analysis

Condition-based maintenance via OnPerformance.Lab, in which Voith experts use data analysis and remote support to optimize system maintenance and operation, holds great potential. "As part of the Digital Health Assessment, we transform the data and discover, for example, that a turbine is taking increasingly longer to stop, and then alert the customer accordingly," explains Dr. Habets. "This information can be used to extend plant maintenance intervals and shift them to times when electricity prices are low. That is true revenue-optimized maintenance planning."

To get there, Voith is deliberately pursuing a digitalization strategy that differs from the big-data approach of large IT providers. Instead of merely analyzing vast quantities of data, the company is also leveraging its domain knowledge and over 150 years of hydropower expertise, the product manager emphasizes. "We come from the engineering sector and understand the customer's problems because we had them ourselves. This means we can translate this into sound advice and customized, extremely specific solutions."

# by Voith



# New Per spec tives

Nepal lies in the Himalayas between China and India. The World Bank sees growth opportunities for Asia's third poorest country in the development of hydropower, among other areas.

Nepal has large hydropower reserves, but can barely tap them. This is what the German Technical School, which was built entirely from donations, wants to change through its vocational training program. It is providing young people and the country opportunities for economic development. Voith, in turn, supports the project on many levels.

## 2009

Beginning of fundraising for a children's village in Dhunibesi (Dhading District).

## 2015

A huge earthquake strikes Nepal. The charitable organization Zukunft für Nepal Ostwürttemberg (Future for Nepal East Wuerttemberg) collects aid supplies for the population. Voith employees contribute through financial and in-kind donations.

## 2016

Voith enters into an agreement with DEG/KfW\* to set up a metal training workshop in Dhunibesi. Construction work begins at the end of the year. The building shell is completed in April 2018. \*(i.e. German Investment & Development Bank)

1,600. Herwig Jantschik only needs a single number to explain Nepal's problem. "Every day, 1,600 young people leave the country to work in the low-wage sector in other countries." The United Nations Development Program (UNDP) ranks the republic in the Himalayas among the 20 poorest nations in the world – due, in part, to the civil war that raged here between 1996 and 2006 and the major earthquake of 2015.

But Jantschik, who works as a social consultant at Voith in Heidenheim, won't let this stop him. He wants to help the country and its people primarily through two means – education and hydropower. "Nepal has 40 GW of exploitable hydropower potential that has not yet been tapped. This is one of the country's major growth projects. But all of the local companies lack hydro-power service technicians, and they are really hungry for personnel," Jantschik notes. His plan is to provide the economy with qualified employees in order to promote the sustainable generation of electricity and at the same time offer Nepalese young people career prospects.

## Nothing is possible in the country without support from locals who are treated as equals.

**Herwig Jantschik**

Zukunft für Nepal Ostwürttemberg Association

The 59-year-old has long had close ties to the country. Together with his wife Petra Pachner, in 2009 he collected numerous donations – including from his colleagues at Voith, among others – to build a children's village in Dhunibesi (Dhading District). In 2013, the idea was born to extend it by adding a general and vocational school including a training workshop to teach metalworking skills. In the fall of 2019, an important milestone was reached in pursuit of this goal: the German Technical School was officially opened in a ceremony that included German Ambassador Roland Schäfer and Nepalese and German politicians and businesspeople.

In between lie around six years and a lot of hard work. "The earthquake in 2015 set us back," Jantschik admits. But he didn't let it discourage him. After the natural disaster, he founded the charitable organization Zukunft für Nepal Ostwürttemberg (Future for Nepal East Wuerttemberg) together with Pachner and the hydropower engineer and Nepalese Pawan Dhakal. And

he launched the "Voithians for Nepal" initiative. Together, they collected money and donations in kind for the earthquake victims in Nepal's remote mountain regions and helped with everything from blankets and dishes to dry food and tents. Voith made sure the expansion of the school could continue. The company not only provided machines for training, but also signed a contract with the KfW subsidiary German Investment and Development Company in 2016 to finance the metal workshop. The 4,000 m<sup>2</sup> plot of land in Dhunibesi was donated to Jantschik and his partners by a local resident. "Nothing is possible in the country without support from locals who are treated as equals," he says.

Five Voith trainees, two trainers, and an engineer who all traveled to Nepal especially for this purpose also provided support – together they set up key infrastructure such as the electricity supply. A particularly long monsoon season meant that the remaining construction work could only be completed six days before the grand opening.



### Bottleneck

The only access road was always impassable during the monsoon season, meaning that construction work had to be postponed.



### Helping on Site

Trainees and trainers from Voith in Heidenheim set up the basic infrastructure at the construction site.

## Achieving lasting results that will endure generations is important to Voith.

**Markus Rieck**

President Asia & Europe,  
Chief Sales Officer,  
Senior Executive Vice President, Voith Hydro



### Grand Opening Ceremony

The official opening in October 2019 was preceded by a festival with all of the villagers.

In the meantime, the training center is up and running. A total of 13 welders are currently learning at the German Technical School. The goal is to train 220 apprentices each year, spread across training workshops focusing on metal, wood, and sewing. Expansion plans have long been in place. "In the future, we want to train hydropower service technicians," says Jantschik, "and we are also going to train electricians, probably starting in 2021."

In the process, he continues to count on his employer. "The partnership with Voith is important to us, because the company has demonstrated its commitment through its donations. We are also discussing sending Voith trainers to seminars in Nepal for a limited period of time." The objective is to achieve the highest possible teaching quality and thus help the country and its people to develop.

## Liquid Gold

At around 147,000 km<sup>2</sup>, Nepal occupies only a relatively small area – but almost 4,000 km<sup>2</sup> of it consists of inland waterways.

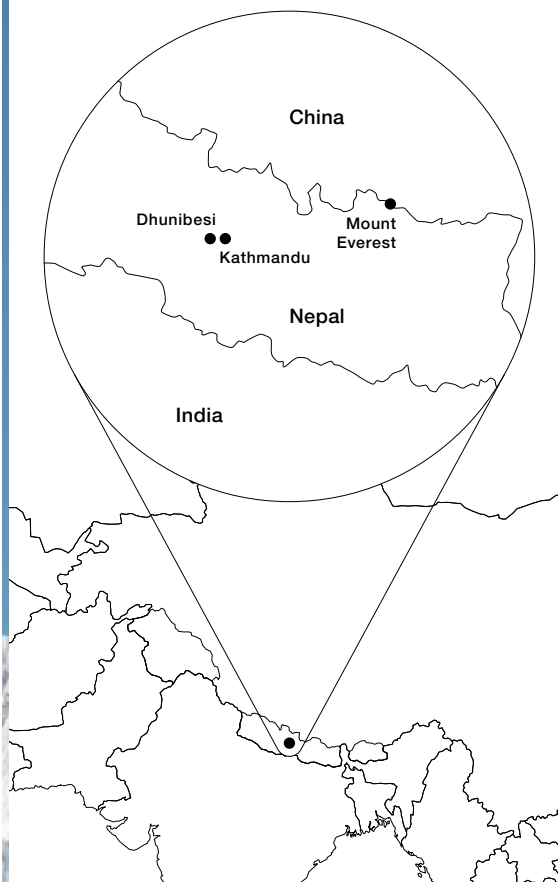

### Initiators

Petra Pachner, Herwig Jantschik,  
and Pawan Dhakal (not pictured) coordinated  
the construction of the school.

Meanwhile, around 6,500 kilometers away from Nepal, Jantschik continues to work on the project and get his colleagues involved. Voith's cafeteria in Heidenheim hosts three "Nepalese Days" each year, serving a meal similar to the local lentil dish Dal Bhat. These lentils with Spätzle, a Swabian specialty, then cost one euro more – another contribution that helps out in the Himalayas.

German  
Technical School

## 2019

The machines required arrive at the beginning of the year. Voith trainees and instructors begin setting up the infrastructure. Parts of the workshop are brought in to operation in April. The grand opening ceremony with political and business leaders follows in October.

## 2021

The program will be expanded to include vocational training to be an electrician.



p. 31 —————> 41

# reflect

Insights and Inside Views

## Extensive Power Plant Modernization in Canada

To support its plant modernization efforts, the Canadian utility Ontario Power Generation has selected Voith to perform two turbine generator overhaul projects across the province. At the iconic Niagara Falls, Voith is refurbishing U5, one of 10 units at the Sir Adam Beck 1 generating station, which was built almost a century ago. The scope of work includes the overhaul of the generator and 55 megawatt turbine. Voith will supply new components, including the head cover, bottom ring and wicket gates, as well as perform inspections on its civil works. A significant upgrade of the balance of plant electrical equipment is included along with a complete overhaul of the generator. The modernizing of the single-unit Silver Falls generating station, located in northwest Ontario, will be done in parallel. Voith has redesigned a new generator stator core and windings to increase unit performance and reduce an existing vibration problem. The scope also includes refurbishment of the turbine.



# Adventures in Commissioning

Implementing complex hydropower projects in faraway countries and foreign cultures – a commissioning engineer's job is both fascinating and challenging. Simon Walch, Head of Commissioning at Voith Hydro in Heidenheim, Germany, describes the skills he requires and the career opportunities he opens up.



Ingula

## What role do social skills play?

A major one. As a commissioning engineer, you are the interface between the customer and the supplier, between the technology and the schedule, in short, between a variety of different stakeholders. If you can't get the turbine up and running while 20 of your coworkers and 30 of the customer's employees are standing around asking, "So what now?", then you have to keep cool, mediate between the parties, and come up with a satisfactory solution.

## Can you provide a rough outline of a typical commissioning job?

It begins with preparations back at the office. The commissioning engineer first familiarizes themselves with the project and carefully reviews the contract, meets with the design engineers, goes through the designs, and identifies points of contact with installers and the customer. They define the scope and sequence of testing and select the measuring instruments and tools. On the job site, they then take over responsibility for the individual trades from the assembly team.

## ZAF

### South Africa

The Ingula Pumped Storage Station plays an important role in stabilizing the country's power grid.



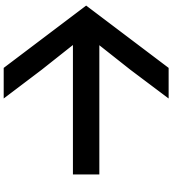

**Planning**

Each commissioning project is preceded by a thorough review of the contract and consultations with designers, installers, and the customer.

**Mr. Walch, through your work on numerous international projects, you have first-hand knowledge of the profession of commissioning engineer. What do you find so appealing about this job?**

There are several things. One is the technical challenge – you gain a comprehensive overview of the entire plant in a very short time, which hardly anyone else has. From the generator to the turbine, auxiliary systems, auxiliary plants and control technology, at some point you know the entire power plant like the back of your hand and yet still learn something new every day.

Moreover, it is a very demanding profession in terms of the actual tasks. We need to solve problems and fix errors or malfunctions, often improvising and finding a neat and cost-effective solution as quickly as possible, even under time pressure.

This means you are pushed to the limit right from the start. As a person, you grow tremendously in this profession, because you take on a lot of responsibility and have to learn to handle it.

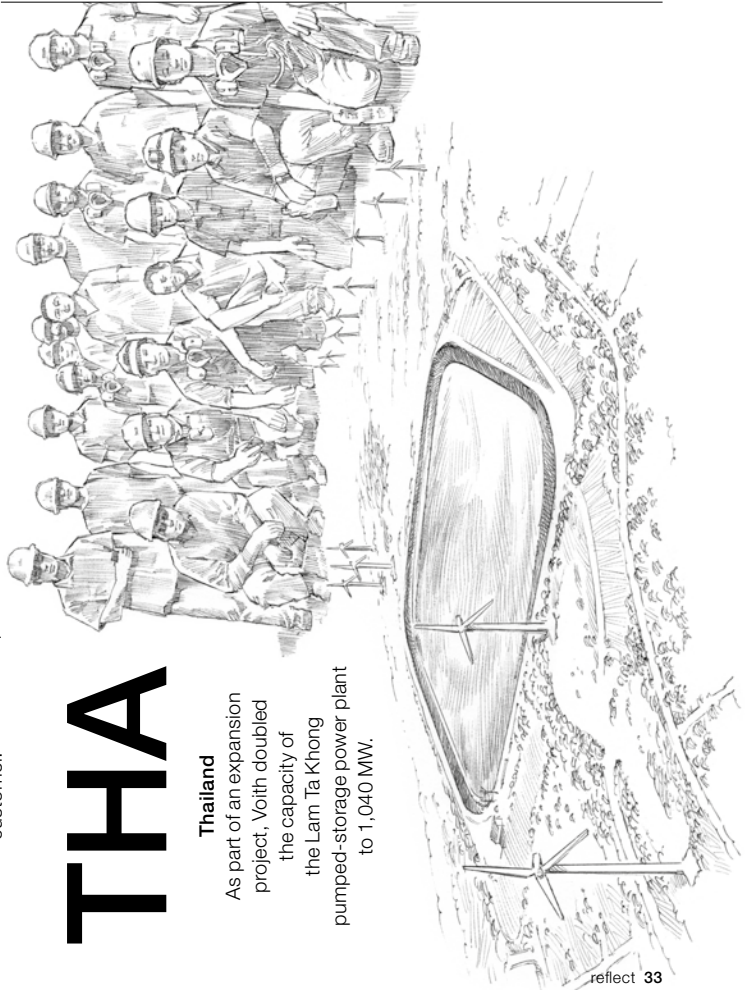

**THA**

**Thailand**

As part of an expansion project, Voith doubled the capacity of the Lam Ta Khong pumped-storage power plant to 1,040 MW.

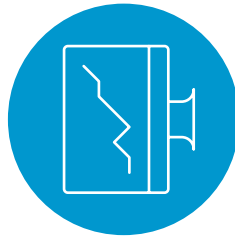

**Control**

Still in the office, the commissioning engineer defines the scope and sequence of testing and selects the measuring instruments and tools.

First the individual systems are commissioned “dry,” i.e., at a standstill. When all of the systems are ready, the wet commissioning process begins. This is the first time the generator set is turned on. Depending on the type of power plant and scope of supply, tests are carried out over several days or weeks.

Every unit is a prototype and you have to imagine the dimensions in which we work – a turbine with a capacity of several hundred megawatts can have a head of 1,200 meters or a flow rate of over 100 cubic meters per second. In the event of an emergency shutdown, it needs to be stopped within seconds. There’s no margin for error. →



● Lam Ta Khong



# ISL

## Iceland

An acoustic monitoring system based on machine learning and artificial intelligence has been used for predictive maintenance of the Búðarháls Hydropower Plant since 2018.



## What do you consider the greatest challenge of your work?

Actually, it's the unforeseen things – these can be technical issues, but also external influences such as floods, riots, strikes, or supply shortages. In South Africa, for example, grid fluctuations occurred due to outages at other power plants. This meant we had to interrupt our commissioning tests and temporarily run the generator by hand to supply the grid with power for a short time, particularly early in the morning and late in the evening.

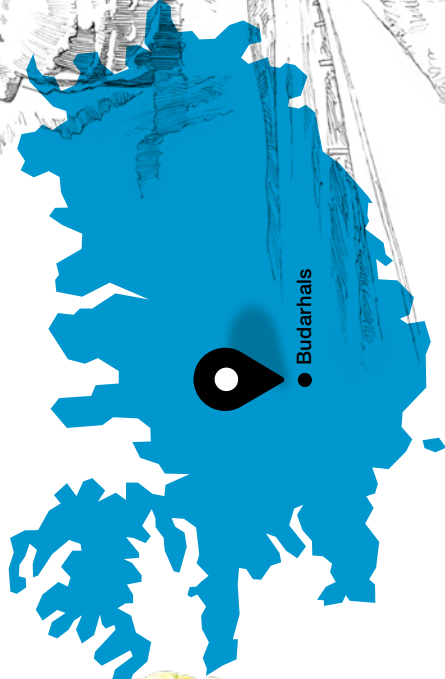

## Have you ever found yourself in a sticky situation?

Yes, in Iceland we got caught in a heavy snowstorm on the way home. Visibility dropped to zero and two out of four vehicles got stuck. We had to pull together and fight our way through the last 30 kilometers, which took more than three hours. The next day, the sun was shining brightly and the customer's employees pulled our vehicles back onto the road. We thanked them with a few beers after work. We generally also work in locations where the situation on the ground is precarious or a medical facility is far away. That's why Voith draws up safety concepts and can evacuate employees or postpone operations in an emergency.

It isn't only a question of the country, but also of the people on the team. The intercultural challenges reveal themselves during day-to-day work together, as well as during meals; the cafeteria chef can never please everyone. On religious holidays or festivals, the teams also have to come to an agreement – we try to ensure that our Islamic colleagues can leave work a little earlier during Ramadan in order to break the fast in the evening, for example. In the same vein, we try to ensure that other colleagues have time off during the Hindu festival of lights or on Christmas.

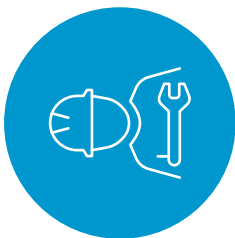

**About  
Simon Walch**

Simon Walch works as Head of Commissioning for Voith Hydro in Heidenheim. From there he coordinates the work on hydropower projects in Western Europe, Africa and parts of Asia, among other tasks. In addition, he supports the teams themselves on site, if necessary.

The now 30-year-old completed a cooperative education program in mechanical engineering at Siemens in 2009. He joined Voith Hydro in 2013. After various assignments as a turbine commissioning engineer, Walch was appointed commissioning manager for the Ingula Pumped Storage Scheme project in South Africa. After its completion, in 2017 he transferred to Voith Hydro Shanghai (China) to manage the commissioning of the Lam Ta Khong project in Thailand. He returned to Germany in 2018 and has worked here in his current position ever since.

**Commissioning engineers communicate directly with the customer. How much diplomatic skill and social competence do they need to possess?**

A lot! You really are the face of the company for the customer and other stakeholders on the job site. If you establish rapport and support each other during on-site activities – but also outside of the contract – it helps a lot. For example, you may carpool after work to watch a movie together at the nearby theater, or go hiking together on your day off.

**Does this extremely close collaboration with customers help you develop your own professional and interpersonal skills?**

Yes, definitely. You're often confronted with things that you'd never encounter in a normal office environment. Sometimes you're on your own when a problem arises in the field. There often isn't much time for discussions or back-and-forth questions. It's the commissioning engineer's responsibility to find a solution, make a decision quickly, and then implement it. This can be very demanding and stressful. But I also love it, because you get to see the results of your work immediately.

**What role do language skills and intercultural understanding play during assignments abroad?**

English is the primary language spoken on many of our job sites, which means you have to speak it to communicate and do your job. Portuguese and French are other languages spoken on many sites. In many cases, you'll also work with local staff who don't speak any foreign languages, so you have to use body language and gestures to communicate.



**What advantages does the job offer beyond the purely professional?**

You learn very, very much, very, very quickly – including about yourself. You have to develop a lot of self-confidence and be extremely open-minded. In addition, you feel a much greater sense of team spirit on a job site than you do at an office. You suffer together, you celebrate the achievements together – it's a much more intense working relationship.

If you're there for a few months or a year and interact with the people on a daily basis, develop a friendly working relationship or even real friendships, then you get to know the country and its culture from a much different perspective than if you were just a tourist. This broadens your horizons tremendously.

**What was your greatest moment of happiness so far after successfully completing a commissioning project?**

That was after the Ingula contract in South Africa, which was a complex project involving many different trades. I had just recently taken over as Head of Commissioning and had 40 colleagues from 20 different countries on my team. The dry commissioning phase was very challenging.

When we finally turned on the first turbine and everything worked perfectly, that was just an amazing moment for the whole team and for the customer. We all toasted to it – with non-alcoholic champagne.



**Trial Runs**

Commissioning consists of the "dry phase" (systems at a standstill) and the subsequent "wet phase" (generator set brought into actual operation for the first time).



**Reporting**

After commissioning, all of the departments involved receive feedback. The feedback helps employees learn from any mistakes and further optimize the systems.

Female Potential for  
Hydropower

# “Hy”

# Potentials

The “Women in Hydropower” mentorship program aims to make the field of hydropower more attractive for qualified women and to support female engineers, among other goals. Five North American associations developed the concept, and Voith Hydro supports it and encourages its female employees to participate.



**Haley Lawler**  
Engineer,  
Voith Hydro, York  
(Mentee)

Besides her studies in mechanical engineering with focus on energy systems engineering, Haley Lawler also brought experience from an internship at Volvo Construction Equipment when she joined Voith Hydro in May 2016. Privately, her dog and the work at the local animal shelter are her main activities as well as hiking, reading and baking.

Gigantic buildings with components weighing hundreds of tons, controlled by a complex interplay of mechanics, hydraulics and digital control technology: That's a quick summation of hydropower, and it is not necessarily an industry that women consider first when choosing a profession. But that perception is crumbling. "The presence of women in science and technology is growing worldwide, and I believe this trend will continue in hydro," says Erin Yingling. She speaks from experience. As an engineer at Voith Hydro in York (Pennsylvania, USA), she works in the male-dominated hydropower industry.

The goal of the mentoring program "Women in Hydropower" is to create a better balance and to develop opportunities for female specialists in the industry. The idea is to bring together experienced women with those just starting out, so the exchange of information and ideas can lead to new perspectives and practical solutions for both. This very personal form of support is part of a larger plan. Back in the summer of 2018, the International Hydropower Association declared that it wanted to enhance the role of women in the energy sector while aiming to boost the number of women in management positions.

"I wanted to do something useful for the world and embark on a career in renewable energy," explains Lawler, who is participating in the program as a mentee. However the Voith engineer recognized that hydropower is a traditionally male industry and the proportion of women is low. She said the Society of Women Engineers claims there's a 1 to 8 ratio of women to men in engineering, and the mentoring program helped her not to be intimidated by the imbalance. "My mentor has been working in male-dominated areas for over 20 years now. She had similar problems to me when she entered hydropower but has gradually gained respect and ascended. It was very inspiring for me to hear that," says Lawler.

In addition to the gender distribution, the age difference also plays a role, as her Voith colleague Kiersten McCauslin has noted. "From what I have observed, the average age of the engineers is somewhere between the mid-thirties to late-forties," she says. The female engineers, on the other hand, have often just graduated, which is reflected in the behavior of the older generation toward them. "I found myself in many situations in which a male colleague felt that he had to behave differently because I was a woman." →



## Erin Yingling Engineer, Voith Hydro, York (Mentee)

Holding a degree in biomechanics, Erin Yingling joined Voith Hydro in May 2017. After one and a half years as a quality engineer, she is now working as a development engineer. Her hobbies include hiking and cycling, but above all her dog and her commitment to U.S. animal welfare organization ASPCA.

**The presence of women  
in science and technology  
is growing worldwide,  
and I believe this trend will  
continue in the  
field of hydropower.**

Erin Yingling  
Engineer at Voith Hydro

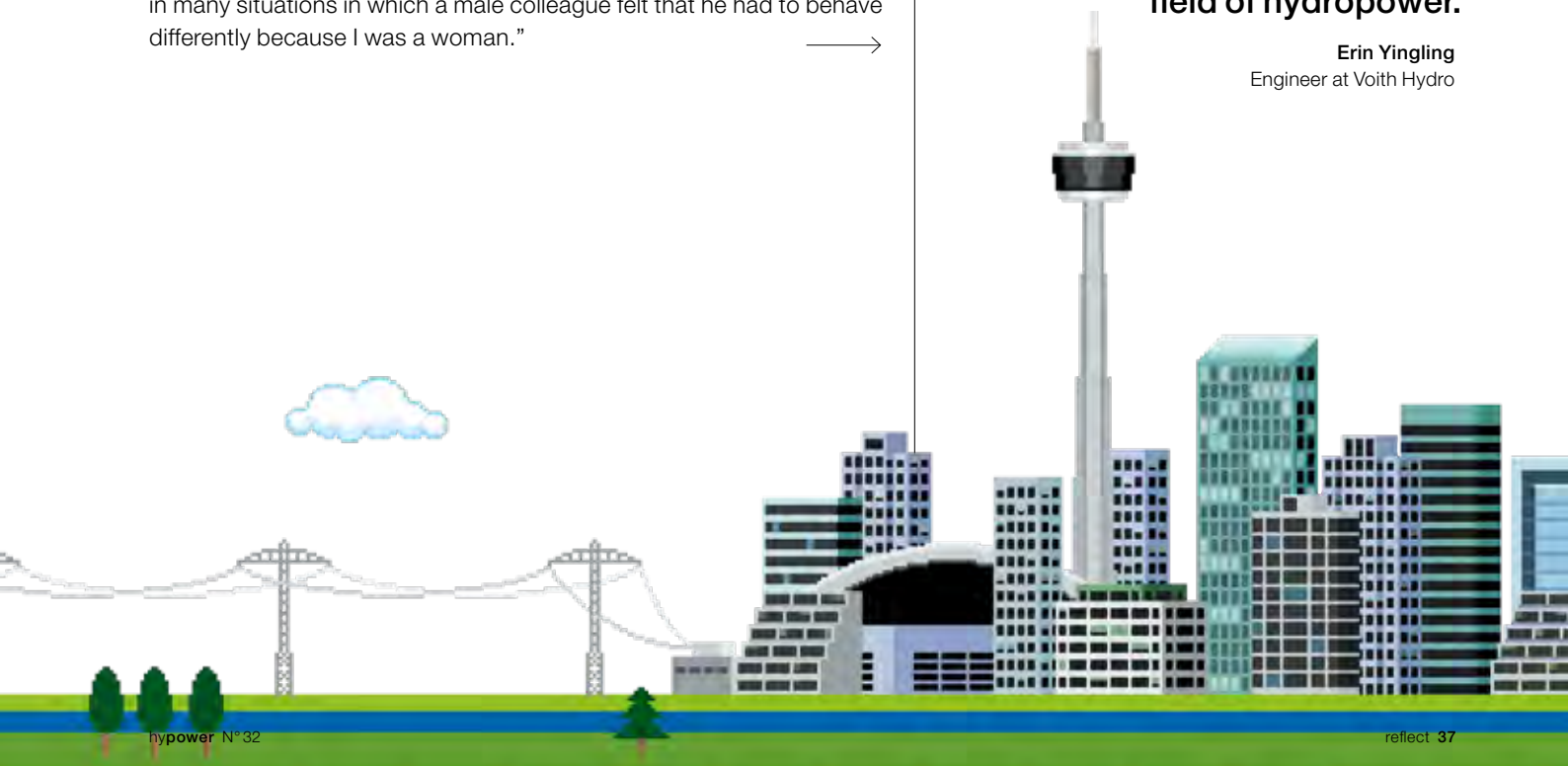

Erin Yingling also had to experience that some men simply don't like working with women, and sometimes they try to make women's jobs more difficult. For example, a supplier once refused to give her required quality documentation but immediately gave it to a male colleague when he requested the same information.

Experienced specialists can confirm these problems. "This is not hydropower-specific – women in engineering and technical professions are often treated differently in the beginning because of the stereotype that they are more emotional," confirms Alyssa Minnier, Area Manager of Assembly in Manufacturing at Voith Hydro and one of the mentors of the program. "This can affect how they are seen and treated under pressure or in challenging situations." The exchange with her program partner, who came from a completely different industry, gave her important insights. "It was very interesting to hear her perspective and to see that she mirrored my experience even though we had very different roles in our companies."

However, a lot may also depend on the area of activity. "If there are different standards applied to men and women, I haven't noticed them," says Stephanie Nielson, Business Development Manager HyService at Voith in Mississauga, Ontario, Canada. "This may be partly due to my sales role and the fact that I deal with engineers and plant managers who make decisions about my product offering and not about me and my capabilities as a whole." For Nielson, who also participates in the program as a mentor, a key to her success was finding her voice and meeting colleagues and customers on a professional level and with a common goal in mind. "Attitude is the most important factor for our acceptance and success," she emphasizes.



**Stephanie Nielson**  
**Business Development Manager**  
**North America,**  
**Voith Hydro, Mississauga**  
**(Mentor)**

The studied administrative scientist originates from British Columbia, Canada. Equipped with marketing experience, she started in sales in the field of electrical engineering before joining Voith Hydro in 2017. In her spare time, Stephanie Nielson writes motivational books, gives lectures and loves painting.



**Kiersten McCauslin**  
**Engineer,**  
**Voith Hydro, York**  
**(Mentee)**

After graduating in mechanical engineering from the University of Pittsburgh, Voith Hydro was the first employer for the engineer in May 2013. Apart from her professional life, Kiersten McCauslin spends most of her time with her family, goes hiking and is interested in movies.

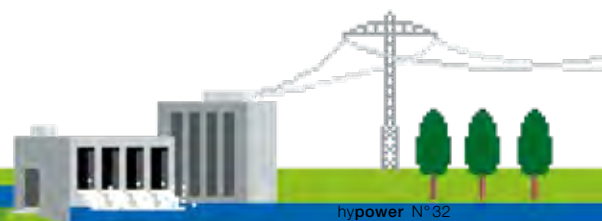
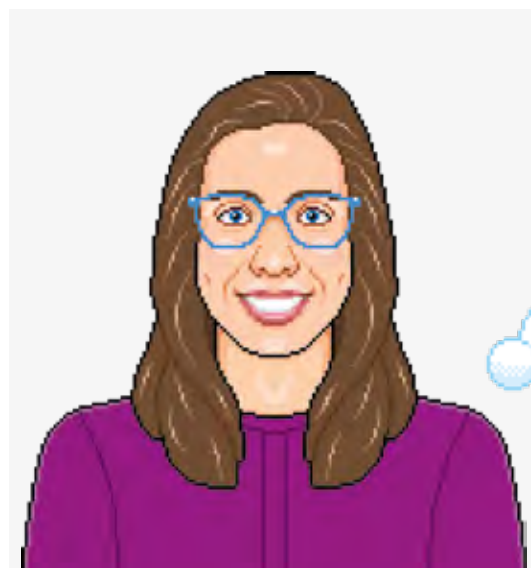

**It was very interesting to hear her perspective and to see that she mirrored my experience even though we had very different roles in our companies.**

**Alyssa Minnier**  
Area Manager Assembly in Manufacturing at Voith Hydro



**Alyssa Minnier**  
Area Manager Assembly in  
Manufacturing, Voith Hydro, York  
(Mentor)

The mechanical engineer is originally from Dillsburg, Pennsylvania, USA. She joined Voith Hydro in June 2012 directly after earning her degree. Outside of work, Alyssa Minnier is interested in 3D printing and woodwork as well as golf, tennis, and hiking.

Kiersten McCauslin can confirm that the mentorship helps develop the self-confidence needed to achieve this attitude and use it in a professional setting. Voith had made her aware of the program. When the engineer subsequently joined it, she had just switched from Engineering to Quality in York. “But I soon realized that my passion was still for engineering,” the young woman recalls. Her mentor encouraged her to talk to the technical manager and make it clear that she’d like to come back as soon as there was an opening. “And I’m happy to say it worked. I now work as a mechanical engineer again.”

Participation in the program has also paid off for Erin Yingling. Her mentor worked for one of Voith’s customers, and as a result of the program, the two not only developed a close relationship, but also gained a positive impression of each other’s company. “I believe that even small personal connections can do a great deal to build trust between companies,” she says.

Kiersten McCauslin also recognizes the benefits of the program for individual companies and the entire industry as a whole. “The hydropower associations want to invest in us women,” she’s convinced. After all, the industry needs the contribution of women, too. “The mentorship program is a way to build our confidence in this industry, which in turn helps the industry retain its female employees over the long term.”

## Mentorship Program

# Women in Hydropower

The “Women in Hydropower” mentorship program aims to specifically help women enter and advance in the hydropower industry. To do so, a steering committee brings mentors and mentees together. Over a period of eight months – each year from October to May – they discuss their experiences once a month for one hour, either in person or on the phone. The initiative aims to help women in the industry connect, generate new friendships, and share experiences in a supportive environment.

It is supported in North America by the Northwest Hydroelectric Association (NWA), Midwest Hydro Users Group (MHUG), WaterPower Canada, the U.S. National Hydropower Association (NHA), and the International Hydropower Association (IHA), among others; Voith is a member of some of these organizations.

For further information, send an e-mail to:  
[womeninhydropower@gmail.com](mailto:womeninhydropower@gmail.com)



# Out of the Box

## Hydropower and Architecture

### Architecture can positively influence the public perception of hydropower.

Aesthetics aren't everything. Industrial structures are much more heavily dependent on the functional demands that influence their architecture than other building categories. The design of hydropower plants has to meet particularly high demands. Their size alone makes integrating them into an urban or natural environment a challenge. "The relationship between context and scale is often given little consideration," says Nanna Meidell, architect at the Norwegian consulting firm Norconsult. On top of this, there is also the expectation that power plants be able to operate efficiently over a lifetime of more than 100 years. "Within this rather inflexible framework, the architect must focus on other design elements."

#### Transparency

The Norwegian small hydropower plant Øvre Forsland features glass surfaces in the facade that offer a view of the plant's heart, the generator sets.

Meidell has demonstrated what these look like with the Norwegian run-of-river power plant Vamma (see page 10). She deliberately set the monolithic-looking new building in the shape of a cube apart from the older existing buildings by means of large panes of glass in the anthracite-colored facade that are almost reminiscent of stained glass windows, which gives the building an interesting look and creates an effect as positive as it is exciting. "Outstanding architecture in this type of project requires extraordinarily close collaboration with the engineers," the architect emphasizes.

Michael Becker confirms this as well. His architectural firm designed the Iller power plant in Kempten, Germany, which has won several awards, and had to meet particularly high demands in the process, as the plant is not located in the middle of nowhere, but right downtown. This is why Becker covered the weir, inlet, and turbine house with a wave-like concrete sculpture, the shape of which subtly evokes associations with currents and water. "The Iller hydropower plant attempts to revitalize the industrial location, with its distinctive brick architecture and the historically significant series of bridges, as an urban space with an appealing atmosphere for the city's residents," explains the architect. Designed in this way, it represents a connecting element.



**Architecture, particularly that of infrastructure facilities, should always blend into the environment and react to it in a subtle way.**

**Michael Becker**  
Becker Architects, Germany

**1 Interior View**

The concrete, including signs of formwork, can only be seen from the inside. To protect the complex shell structure, the exterior consists of crushed river pebbles applied to a seamless film coating.

**2 Water Sculpture**

The shell, reminiscent of a stone formed by water, limits the inflow and covers the turbine house, which is home to two Francis turbines.



Just like his colleague Nanna Meidell, Becker generally believes that the public accepts hydropower as a sustainable form of energy production. But this doesn't mean that the architectural requirements are any less demanding. On the contrary: "A hydropower plant will always have to meet high design standards because it is part of the infrastructure that is currently changing and will shape our man-made environment even more than it does today," Becker contends.

# Intelligent Solutions Lay the Foundation for the Digital Power Plant

HH20

**VOITH**

Inspiring Technology  
for Generations